

1 2 3
4 5 6
7 8
9 0

EXPORT PRICE LIST 2015

—

NOTE SULLE FINITURE

Vetro soffiato

Il vetro soffiato è la risultante di una lavorazione artigianale e non industriale e seriale.

Ogni oggetto, per quanta attenzione possa mettere il maestro vetraio, sarà diverso l'uno dall'altro, sia in termini di dimensione che di forma e finitura.

Questa diversità rende ogni oggetto creato dai mastri vetrai, unico ed esclusivo.

Ogni imperfezione, quindi, sia essa in termini di forma, dimensione o finitura, non costituisce certo difetto, ma una caratteristica tipica del lavoro manuale.

NOTE SUL BTOB

Il BtoB di Fabbian (<http://b2b.fabbian.com:8080/login.jsf>), vi permette di connettervi alla rete aziendale per:

- creare quotazioni per i vostri progetti
- inserire ordini in modo immediato, monitorandone lo stato
- verificare le date di consegna
- visualizzare e scaricare le comunicazioni ufficiali dell'azienda
- consultare e scaricare tutti i propri dati commerciali e amministrativi, nei formati più utilizzati

il tutto in tempo reale, e ovunque vi troviate.

INFORMATION ON THE GOODS' FINISHING

Blown glass

Blown glass is the result of an artisanal process. It is a hand-made product that does not involve any industrial or mass production process.

Despite the abilities of the artisan, every glass will be different from the other in terms of size, shape and finish.

Every glass blown by the "Mastro vetraio" (master of glass) is unique and special.

No imperfection, in terms of size, shape and finish, is a defect, but rather the distinguishing feature of a hand-made product.







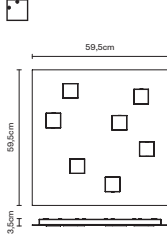

INFORMATION ON B2B

Fabbian's B2B platform (<http://b2b.fabbian.com:8080/login.jsf>) allows you to connect with the company and:

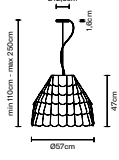
- make quotations for your projects
- efficiently make orders and follow their status
- view the delivery dates
- view and download official communications from Fabbian
- browse and download all administrative information and documents (in the most common formats)

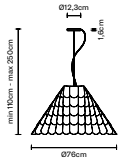
at any time, wherever you are.

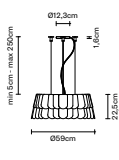
Guida alla consultazione Reference Guide

Nome collezione Collection name		Codice collezione Collection code	Novità News	Prodotto a led Led product			Specifiche tecniche e accessori inclusi Technical info and accessories included
Designer collezione Collection designer		code	price €	bulb code (not incl.)	bulb price €	electrification	
QUARTER F38 Pellegrini+Mengato Design 		F38 G13 01 White 02 Black	482,00 € 588,04 € (iva 22%)			LED 7x4,5W WHITE 2700K ChI 80	0,180 m³ 6,50 Kg IP40
ROOFER F12 Benjamin Hubert 		F12 A01 01 White 21 Anthracite 32 Orange 43 Green	479,00 € 584,38 € (iva 22%)	A10209C12  A10218C10 	12x15,27 € 12x18,63 € (iva 22%) 10x21,48 € 10x26,21 € (iva 22%)	E27 1x205W HSGST E27 1x30W FBT	0,380 m³ 5,50 Kg IP20
D27 F56 Tipologia e codice articolo Typology and article code 		F12 A03 01 White 21 Anthracite 32 Orange 43 Green	519,00 € 633,18 € (iva 22%)	A10209C12  A10218C10 	12x15,27 € 12x18,63 € (iva 22%) 10x21,48 € 10x26,21 € (iva 22%)	E27 1x205W HSGST E27 1x30W FBT	0,380 m³ 5,50 Kg IP20
F12 A05 Tipologia del prodotto Typology Esempio Example 		F12 A05 01 White 21 Anthracite 32 Orange 43 Green	472,00 € 575,84 € (iva 22%)	A10217C10 	10x16,69 € 10x20,37 € (iva 22%)	E27 6x22W FBT	0,100 m³ 4,00 Kg IP20
134 Fabbian Europe Price List 2015		Colore o finitura Colour or finishing	Lampadina Bulb	Posizione lampadina Bulb position		Scheda tecnica elettrificazione Electrification technical form Note Note	Codice lampadina Bulb code Lampadina alternativa Alternative bulb

Il presente listino non può essere copiato, scansionato o riprodotto con qualsiasi mezzo. Tutti i diritti riservati.

Immagine, descrizioni, dimensioni e dati tecnici sono da considerarsi puramente indicativi. Pur mantenendo le caratteristiche di base del prodotto, il produttore si riserva il diritto di apportare modifiche in qualsiasi momento, con il solo scopo di miglioramento.

This price list cannot be copied, scanned or reproduced by any means. All rights reserved.

Pictures, descriptions, dimensions and technical data have to be considered as purely indicative. While maintaining the basic characteristics of the product, the manufacturer reserves the right to make modifications at any time with the sole aim of improvement.

Collections

Index

- **Aérost** p. 7-8
- **Angle** p. 9
- **Becky** p.9
- **Beluga Alu** p. 10
- **Beluga Colour** p. 10-13
- **Beluga Steel** p. 14-17
- **Beluga White** p. 17-21
- **Bijou** p. 21-23
- **Binario** p. 23-24
- **Boomy** p. 24
- **Cloudy** p. 25-26
- **Clove** p. 26-27
- **Cricket** p. 27-31
- **Crio** p. 32
- **Cubetto** p. 32-42
- **Cyclone** p. 42
- **Diamond & Swirl** p. 43-46
- **Dono** p. 46-47
- **Enck** p. 48
- **Eyes** p. 48-49
- **Factory** p. 49-50
- **Faretti** p. 50-58
- **Flow** p. 59-60
- **Giro** p. 61
- **Giunco** p. 62
- **Glu** p. 63
- **Hungry** p. 63-64
- **Jazz** p. 64-65
- **Kone** p. 66
- **Kwark** p. 66
- **Lamas** p. 67
- **Laminis** p. 68-91
- **Loop** p. 92
- **Lumi** p. 92-110
- **Matisse** p. 110
- **Mia** p. 110
- **Mono & Easy** p. 111-112
- **Multispot** p. 113-123
- **No More** p. 124
- **Orbis** p. 124-127
- **Oru** p. 127
- **Paddle** p. 128
- **Pivot** p. 129
- **Plano** p. 129-130
- **Polair** p. 131
- **Puà** p. 131
- **Pulse** p. 131-132
- **Quadriled** p. 132
- **Quarter** p. 133-134
- **Roofers** p. 134-135
- **Slot** p. 135-138
- **Snake** p. 139
- **Sospesa** p. 139-141
- **Spirito di Venezia** p. 141-142
- **Stick** p. 142-145
- **Swing** p. 146
- **Teorema** p. 147-149
- **Tile** p. 150-170
- **Tools** p. 171-179
- **Toroidale** p. 180
- **Twirl** p. 180
- **Venere** p. 180-186
- **Vicky** p. 186-188
- **White** p. 188
- **Zen** p. 189-194

AÉROSTAT F27

Guillaume Delvigne

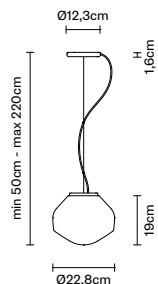

NEW!

code	price €	bulb code (not incl.)	bulb price €	electrification	technical info / accessories incl.
F27 A01 01 White	289,00 €			LED 1x8,7W WHITE 3000K Cri 80	0,035 m ³ 3,00 Kg IP20
F27 A51 01 White	289,00 €			LED 1x8,7W WHITE 2700K Cri 80	0,035 m ³ 3,00 Kg IP20

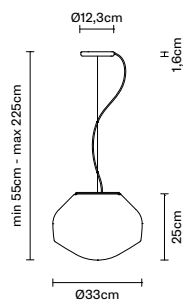

NEW!

F27 A07 01 White	277,00 €	A10208C12 	12x16,41 €	E27 1x150W HSGST	0,070 m ³ 5,00 Kg IP20
F27 A03 01 White	387,00 €	A10212C10 	10x13,98 €	E27 1x15W FBG	
F27 A53 01 White	387,00 €			LED 1x24W WHITE 3000K Cri 80	0,070 m ³ 5,00 Kg IP20
F27 A53 01 White	387,00 €			LED 1x24W WHITE 2700K Cri 80	0,070 m ³ 5,00 Kg IP20

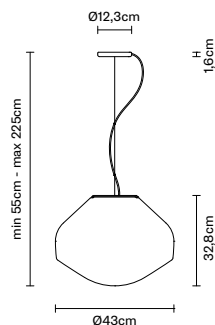

NEW!

F27 A09 01 White	348,00 €	A10209C12 	12x16,80 €	E27 1x205W HSGST	0,070 m ³ 6,50 Kg IP20
F27 A05 01 White	458,00 €	A10218C10 	10x23,63 €	E27 1x30W FBT	
F27 A05 01 White	458,00 €			LED 1x24W WHITE 3000K Cri 80	0,070 m ³ 6,50 Kg IP20
F27 A55 01 White	458,00 €			LED 1x24W WHITE 2700K Cri 80	0,070 m ³ 6,50 Kg IP20

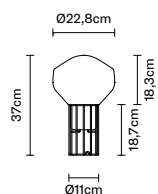

F27 B01 19 Brass-plated 24 Black chrome	257,00 €	A10102C10 	10x5,00 €	E14 1x46W HSGSB	0,040 m ³ 3,00 Kg IP20
		A10106C10 	10x10,55 €	E14 1x11W FBT	

AÉROSTAT F27

Guillaume Delvigne

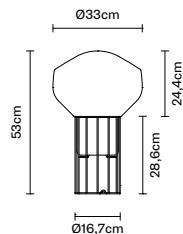

code

price €

bulb code
(not incl.)

bulb price €

electrification

technical info /
accessories incl.

F27 B03
19 Brass-plated
24 Black
chrome

347,00 €

A10208C12

12x16,41 €

E27 1x150W
HSGSB

0,080 m³
5,00 Kg
IP20

A10218C10

10x23,63 €

E27 1x30W
FBT

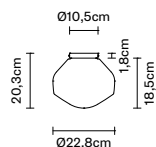

F27 G01
01 White

219,00 €



LED 1x8,7W
WHITE 3000K Cri 80

0,035 m³
3,00 Kg
IP40

NEW!

F27 G51
01 White

219,00 €



LED 1x8,7W
WHITE 2700K Cri 80

0,035 m³
3,00 Kg
IP40

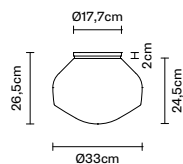

F27 G07
01 White

218,00 €

A10208C12

12x16,41 €

E27 1x150W
HSGST

0,070 m³
5,00 Kg
IP40

A10212C10

10x13,98 €

E27 1x15W
FBG

F27 G03
01 White

273,00 €



LED 1x17,5W
WHITE 3000K Cri 80

0,070 m³
5,00 Kg
IP40

NEW!

F27 G53
01 White

273,00 €



LED 1x17,5W
WHITE 2700K Cri 80

0,070 m³
5,00 Kg
IP40

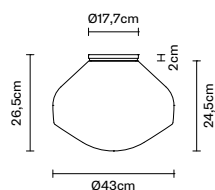

F27 G09
01 White

288,00 €

A10208C12

12x16,41 €

E27 1x150W
HSGST

0,070 m³
6,50 Kg
IP40

A10218C10

10x23,63 €

E27 1x30W
FBT

F27 G05
01 White

343,00 €



LED 1x17,5W
WHITE 3000K Cri 80

0,070 m³
6,50 Kg
IP40

NEW!

F27 G55
01 White

343,00 €



LED 1x17,5W
WHITE 2700K Cri 80

0,070 m³
6,50 Kg
IP40

ANGLE F05

Pamio Design

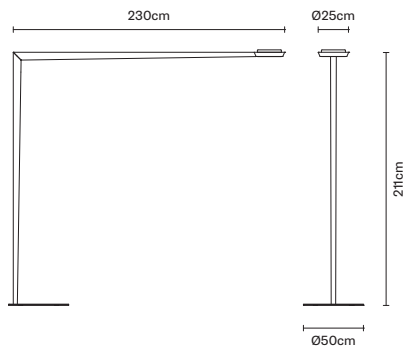

code

price €

bulb code
(not incl.)

bulb price €

electrification

technical info /
accessories incl.

F05 C01
01 White
02 Black

3.816,00 €



MICROLED 180 LED
tot. 20W
WHITE 3000K Cri 80

0,210 m³
20,00 Kg
IP20

In esaurimento (extra 50%) / While stocks last (extra 50%)

BECKY F16

Bridgewell Consulting LTD

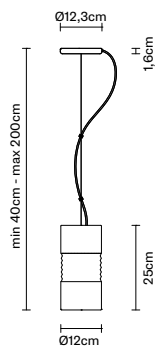

code

price €

bulb code
(not incl.)

bulb price €

electrification

technical info /
accessories incl.

F16 A01
01 White
71 Translucent
white

191,00 €

A11004C20

20x3,91 €

G9 1x60W
HSGS

0,040 m³
2,50 Kg
IP20

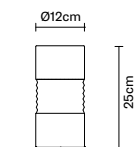

F16 B01
01 White
71 Translucent
white

127,00 €

A11002C20

20x3,91 €

G9 1x33W
HSGS

0,040 m³
2,30 Kg
IP20

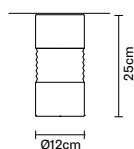

F16 E01
01 White
71 Translucent
white

143,00 €

A11004C20

20x3,91 €

G9 1x60W
HSGS

0,040 m³
2,20 Kg
IP20

BELUGA ALU D57

Marc Sadler

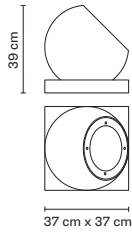

code	price €	bulb code (not incl.)	bulb price €	electrification	technical info / accessories incl.
D57 C07 02 Black	996,00 €	A10220C01 	1x17,58 €	E27 1x75W IPAR	0,135 m ³ 17,90 Kg IP65
		A10227C01 	1x101,53 €	E27 1x14,5W	
		A10218C10 	10x23,63 €	E27 1x30W FBT	
D57 C09 02 Black	1.078,00 €	A11302C01 	1x46,86 €	G12 1x70W MT η 88,10%	0,135 m ³ 17,90 Kg IP65
		A10220C01 	1x17,58 €	E27 1x75W IPAR	
		A10227C01 	1x101,53 €	E27 1x14,5W	
D57 C07 11 Polished aluminium	1.223,00 €	A10220C01 	1x17,58 €	E27 1x75W IPAR	0,135 m ³ 17,90 Kg IP65
		A10227C01 	1x101,53 €	E27 1x14,5W	
		A10218C10 	10x23,63 €	E27 1x30W FBT	
D57 C09 11 Polished aluminium	1.300,00 €	A11302C01 	1x46,86 €	G12 1x70W MT η 88,10%	0,135 m ³ 17,90 Kg IP65

BELUGA COLOUR D57

Marc Sadler



code	price €	bulb code (not incl.)	bulb price €	electrification	technical info / accessories incl.
D57 A11 00 Transparent	175,00 €	A11103C20 	20x6,06 €	GU10 1x75W HAGS η 98,00%	0,028 m ³ 2,05 Kg IP20
		A11105C01 	1x52,72 €	GU10 1x5,5W	
D57 A11 03 Red 04 Yellow 31 Blue 41 Copper 43 Green	187,00 €	A11103C20 	20x6,06 €	GU10 1x75W HAGS η 98,00%	0,028 m ³ 2,05 Kg IP20
		A11105C01 	1x52,72 €	GU10 1x5,5W	

BELUGA COLOUR D57

Marc Sadler

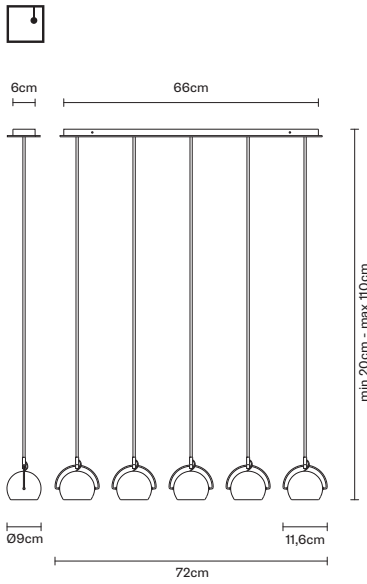

code
—
D57 A15
00 Transparent

price €
—
1.093,00 €

bulb code (not incl.)
—
A11103C20

bulb price €
—
20x6,06 €

electrification
—
GU10 5x75W
HAGS η 98,00%

technical info / accessories incl.
—
0,028 m³
8,65 Kg
IP20

A11105C01 1x52,72 €

LED

GU10 5x5,5W

D57 A15
03 Red
04 Yellow
31 Blue
41 Copper
43 Green

price €
—
1.153,00 €

A11103C20 20x6,06 €

GU10 5x75W
HAGS η 98,00%

0,028 m³
8,65 Kg
IP20

A11105C01 1x52,72 €

LED

GU10 5x5,5W

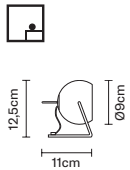

D57 B03
00 Transparent

price €
—
112,00 €

A11101C20 20x10,16 €

GU10 1x50W
HAGS η 98,00%

0,004 m³
1,00 Kg
IP20

A11105C01 1x52,72 €

LED

GU10 1x5,5W

D57 B03
03 Red
04 Yellow
31 Blue
41 Copper
43 Green

price €
—
124,00 €

A11101C20 20x10,16 €

GU10 1x50W
HAGS η 98,00%

0,004 m³
1,00 Kg
IP20

A11105C01 1x52,72 €

LED

GU10 1x5,5W

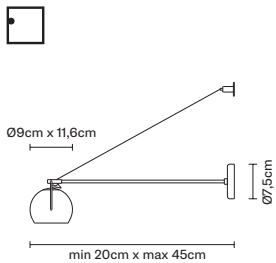

D57 D03
00 Transparent

price €
—
174,00 €

A11103C20 20x6,06 €

GU10 1x75W
HAGS η 98,00%

0,017 m³
1,35 Kg
IP20

A11105C01 1x52,72 €

LED

GU10 1x5,5W

D57 D03
03 Red
04 Yellow
31 Blue
41 Copper
43 Green

price €
—
186,00 €

A11103C20 20x6,06 €

GU10 1x75W
HAGS η 98,00%

0,017 m³
1,35 Kg
IP20

A11105C01 1x52,72 €

LED

GU10 1x5,5W

BELUGA COLOUR D57

Marc Sadler

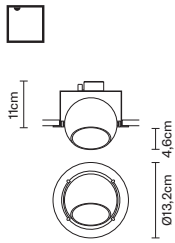

code
—
D57 F01
00 Transparent

price €
—
127,00 €

bulb code (not incl.)
—
A11103C20

bulb price €
—
20x6,06 €

electrification
—
GU10 1x75W
HAGS η 98,00%

technical info / accessories incl.
—
0,011 m³
2,60 Kg
IP20

D57 F01
03 Red
04 Yellow
31 Blue
41 Copper
43 Green

139,00 €

A11103C20

A11105C01
 LED

20x6,06 €
1x52,72 €

GU10 1x75W
HAGS η 98,00%
GU10 1x5,5W

0,011 m³
2,60 Kg
IP20

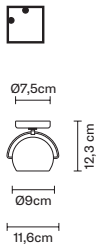

code
—
D57 G13
00 Transparent

price €
—
121,00 €

A11103C20

A11105C01
 LED

20x6,06 €
1x52,72 €

GU10 1x75W
HAGS η 98,00%
GU10 1x5,5W

0,004 m³
1,00 Kg
IP20

D57 G13
03 Red
04 Yellow
31 Blue
41 Copper
43 Green

133,00 €

A11103C20

A11105C01
 LED

20x6,06 €
1x52,72 €

GU10 1x75W
HAGS η 98,00%
GU10 1x5,5W

0,004 m³
1,00 Kg
IP20

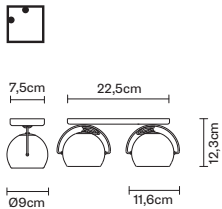

code
—
D57 G23
00 Transparent

price €
—
306,00 €

A11103C20

A11105C01
 LED

20x6,06 €
1x52,72 €

GU10 2x75W
HAGS η 98,00%
GU10 2x5,5W

0,012 m³
2,85 Kg
IP20

D57 G23
03 Red
04 Yellow
31 Blue
41 Copper
43 Green

330,00 €

A11103C20

A11105C01
 LED

20x6,06 €
1x52,72 €

GU10 2x75W
HAGS η 98,00%
GU10 2x5,5W

0,012 m³
2,85 Kg
IP20

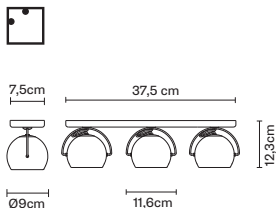

code
—
D57 G25
00 Transparent

price €
—
459,00 €

A11103C20

A11105C01
 LED

20x6,06 €
1x52,72 €

GU10 3x75W
HAGS η 98,00%
GU10 3x5,5W

0,016 m³
4,14 Kg
IP20

D57 G25
03 Red
04 Yellow
31 Blue
41 Copper
43 Green

495,00 €

A11103C20

A11105C01
 LED

20x6,06 €
1x52,72 €

GU10 3x75W
HAGS η 98,00%
GU10 3x5,5W

0,016 m³
4,14 Kg
IP20

BELUGA COLOUR D57

Marc Sadler

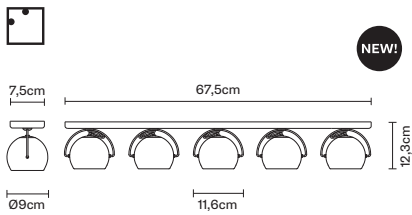

NEW!

D57 G33
00 Transparent
765,00 €

bulb code (not incl.)	bulb price €	electrification	technical info / accessories incl.
A11103C20	20x6,06 €	GU10 5x75W HAGS η 98,00%	0,005 m ³ 6,00 Kg IP20
A11105C01	1x52,72 €	GU10 5x5,5W	

NEW!

D57 G33
03 Red
04 Yellow
31 Blue
41 Copper
43 Green
825,00 €

A11103C20	20x6,06 €	GU10 5x75W HAGS η 98,00%	0,005 m ³ 6,00 Kg IP20
A11105C01	1x52,72 €	GU10 5x5,5W	

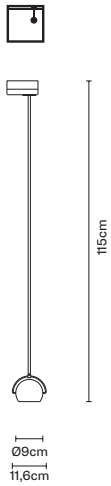

D57 J05
00 Transparent
178,00 €

A11103C20	20x6,06 €	GU10 1x75W HAGS η 98,00%	0,028 m ³ 2,05 Kg IP20
A11105C01	1x52,72 €	GU10 1x5,5W	

Binario p. 204 / Track p. 204

D57 J05
03 Red
04 Yellow
31 Blue
41 Copper
43 Green
190,00 €

A11103C20	20x6,06 €	GU10 1x75W HAGS η 98,00%	0,028 m ³ 2,05 Kg IP20
A11105C01	1x52,72 €	GU10 1x5,5W	

Binario p. 204 / Track p. 204

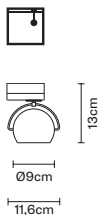

D57 J07
00 Transparent
128,00 €

A11103C20	20x6,06 €	GU10 1x75W HAGS η 98,00%	0,004 m ³ 1,00 Kg IP20
A11105C01	1x52,72 €	GU10 1x5,5W	

Binario p. 204 / Track p. 204

D57 J07
03 Red
04 Yellow
31 Blue
41 Copper
43 Green
140,00 €

A11103C20	20x6,06 €	GU10 1x75W HAGS η 98,00%	0,004 m ³ 1,00 Kg IP20
A11105C01	1x52,72 €	GU10 1x5,5W	

Binario p. 204 / Track p. 204

BELUGA STEEL D57

Marc Sadler

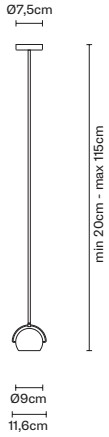

code

D57 A05
15 Chrome

price €

191,00 €

bulb code
(not incl.)

A11103C20

bulb price €

20x6,06 €

electrification

GU10 1x75W
HAGS η 98,00%

technical info /
accessories incl.

0,028 m³
1,55 Kg

IP20 

A11105C01

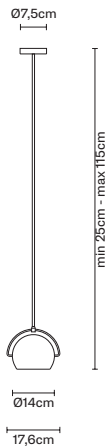

1x52,72 €

GU10 1x5,5W



D57 A07
15 Chrome

257,00 €

A10205C15

15x12,10 €

E27 1x100W
HMGS η 98,00%

0,028 m³
2,04 Kg

IP20 

A10228C01



1x131,21 €

E27 1x9,5W



D57 A09
15 Chrome

416,00 €

A10209C12

12x16,80 €

E27 1x205W
HSGST η 98,00%

0,082 m³
2,76 Kg

IP20 

BELUGA STEEL D57

Marc Sadler

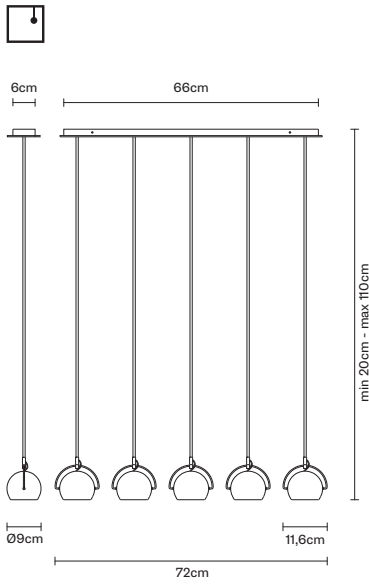

code

price €

bulb code
(not incl.)

bulb price €

electrification

technical info /
accessories incl.

D57 A13
15 Chrome

1.248,00 €

A11103C20

20x6,06 €

GU10 5x75W
HAGS η 98,00%

0,028 m³
6,25 Kg



A11105C01

1x52,72 €

GU10 5x5,5W

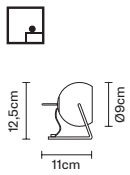

D57 B05
15 Chrome

120,00 €

A11101C20

20x10,16 €

GU10 1x50W
HAGS η 98,00%

0,004 m³
0,60 Kg



A11105C01

1x52,72 €

GU10 1x5,5W

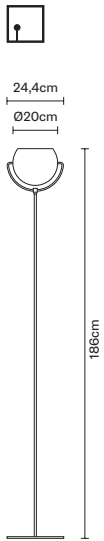

D57 C01
15 Chrome

726,00 €

A10209C12

12x16,80 €

E27 1x205W
HSGST η 98,00%

0,215 m³
10,75 Kg



Variatore luce p. 201 / Light dimmer p. 201

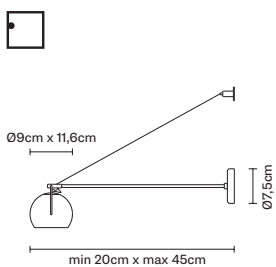

D57 D05
15 Chrome

187,00 €

A11103C20

20x6,06 €

GU10 1x75W
HAGS η 98,00%

0,017 m³
0,81 Kg



A11105C01

1x52,72 €

GU10 1x5,5W

BELUGA STEEL D57

Marc Sadler

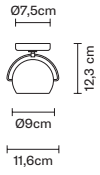

code

price €

bulb code
(not incl.)

bulb price €

electrification

technical info /
accessories incl.

D57 G11
15 Chrome

128,00 €

A11103C20

20x6,06 €

GU10 1x75W
HAGS η 98,00%

0,004 m³
0,56 Kg
IP20

A11105C01

1x52,72 €

GU10 1x5,5W

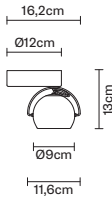

D57 G15
15 Chrome

444,00 €

A11201C01

1x66,90 €

GX10 1x35W
MR η 100,00%

0,005 m³
0,79 Kg
IP20

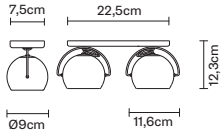

D57 G19
15 Chrome

325,00 €

A11103C20

20x6,06 €

GU10 2x75W
HAGS η 98,00%

0,012 m³
1,85 Kg
IP20

A11105C01

1x52,72 €

GU10 2x5,5W

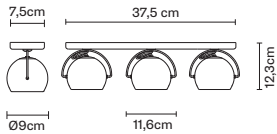

D57 G21
15 Chrome

487,00 €

A11103C20

20x6,06 €

GU10 3x75W
HAGS η 98,00%

0,016 m³
2,76 Kg
IP20

A11105C01

1x52,72 €

GU10 3x5,5W

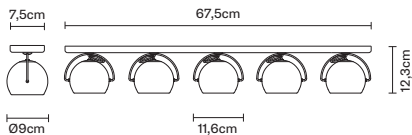

NEW!

D57 G35
15 Chrome

813,00 €

A11103C20

20x6,06 €

GU10 5x75W
HAGS η 98,00%

0,005 m³
4,20 Kg
IP20

A11105C01

1x52,72 €

GU10 5x5,5W

BELUGA STEEL D57

Marc Sadler

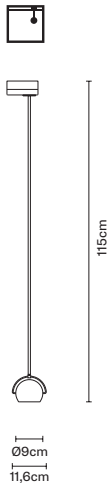

code

price €

bulb code
(not incl.)

bulb price €

electrification

technical info /
accessories incl.

D57 J01
15 Chrome

192,00 €

A11103C20

20x6,06 €

GU10 1x75W
HAGS η 98,00%

0,028 m³
1,55 Kg



A11105C01
 

1x52,72 €

GU10 1x5,5W

Binario p. 204 / Track p. 204

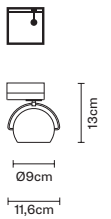

D57 J03
15 Chrome

133,00 €

A11103C20

20x6,06 €

GU10 1x75W
HAGS η 98,00%

0,004 m³
0,56 Kg



A11105C01
 

1x52,72 €

GU10 1x5,5W

Binario p. 204 / Track p. 204

BELUGA WHITE D57

Marc Sadler

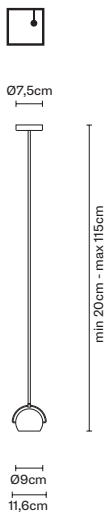

code

price €

bulb code
(not incl.)

bulb price €

electrification

technical info /
accessories incl.

D57 A17
01 White

187,00 €

A11003C20

20x3,91 €

G9 1x48W
HSGS

0,028 m³
2,05 Kg



BELUGA WHITE D57

Marc Sadler

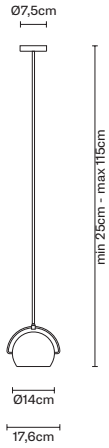

code

price €

bulb code
(not incl.)

bulb price €

electrification

technical info /
accessories incl.

D57 A19
01 White

257,00 €

A11004C20

20x3,91 €

G9 1x60W
HSGS

0,028 m³
2,835 Kg
IP20 

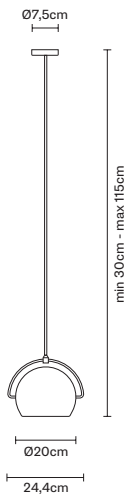

D57 A21
01 White

416,00 €

A10208C12

12x16,41 €

E27 1x150W
HSGST

0,082 m³
3,25 Kg
IP20 

A10212C10

10x13,98 €

E27 1x15W
FBG

BELUGA WHITE D57

Marc Sadler

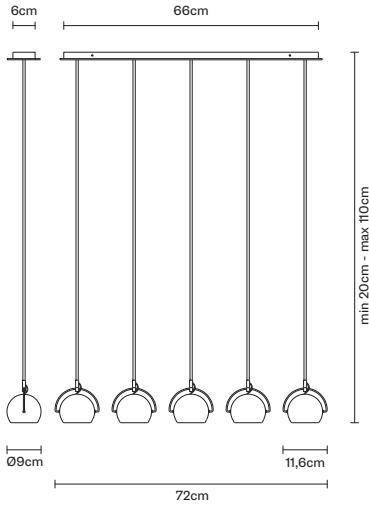

code

D57 A23
01 White

price €

1.153,00 €

bulb code
(not incl.)

A11003C20

bulb price €

20x3,91 €

electrification

G9 5x48W
HSGS

technical info /
accessories incl.

0,028 m³
7,65 Kg
IP20

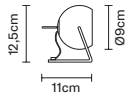

D57 B07
01 White

124,00 €

A11001C20

20x3,91 €

G9 1x20W
HSGS

0,004 m³
1,00 Kg
IP20

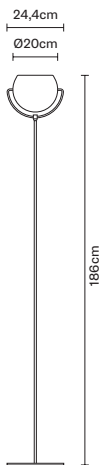

D57 C11
01 White

726,00 €

A10208C12

12x16,41 €

E27 1x150W
HSGST

0,215 m³
12,75 Kg
IP20



10x13,98 €

E27 1x15W
FBG

Variatore luce p. 201 / Light dimmer p. 201

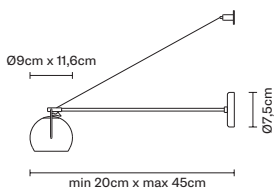

D57 D07
01 White

186,00 €

A11003C20

20x3,91 €

G9 1x48W
HSGS

0,017 m³
1,15 Kg
IP20

BELUGA WHITE D57

Marc Sadler

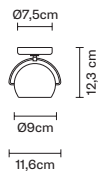

code

price €

bulb code
(not incl.)

bulb price €

electrification

technical info /
accessories incl.

D57 G27
01 White

133,00 €

A11003C20

20x3,91 €

G9 1x48W
HSGS

0,004 m³
0,85 Kg
IP20

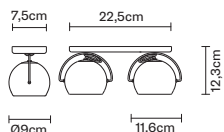

D57 G29
01 White

336,00 €

A11003C20

20x3,91 €

G9 2x48W
HSGS

0,012 m³
2,35 Kg
IP20

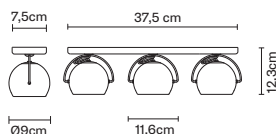

D57 G31
01 White

504,00 €

A11003C20

20x3,91 €

G9 3x48W
HSGS

0,016 m³
3,35 Kg
IP20



NEW!

D57 G37
01 White

840,00 €

A11003C20

20x3,91 €

G9 5x48W
HSGS

0,005 m³
5,20 Kg
IP20

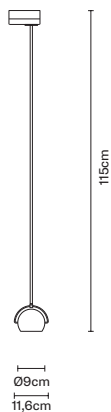
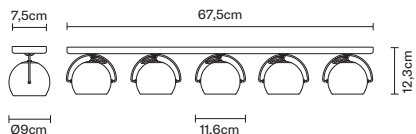

D57 J13
01 White

190,00 €

A11003C20

20x3,91 €

G9 1x48W
HSGS

0,028 m³
1,85 Kg
IP20

Binario p. 204 / Track p. 204

BELUGA WHITE D57

Marc Sadler

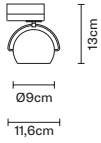

code

price €

bulb code
(not incl.)

bulb price €

electrification

technical info /
accessories incl.

D57 J15
01 White

140,00 €

A11003C20

20x3,91 €

G9 1x48W
HSGS

0,004 m³
0,85 Kg
IP20

Binario p. 204 / Track p. 204

BIJOU D75

Prospero Rasulo



code

price €

bulb code
(not incl.)

bulb price €

electrification

technical info /
accessories incl.

D75 A01
01 White
02 Black

182,00 €

A11103C20

20x6,06 €

GU10 1x75W
HAGS η 98,00%

0,004 m³
0,75 Kg
IP20

A11105C01

1x52,72 €

GU10 1x5,5W

D75 A01
15 Chrome

197,00 €

A11103C20

20x6,06 €

GU10 1x75W
HAGS η 98,00%

0,004 m³
0,75 Kg
IP20

A11105C01

1x52,72 €

GU10 1x5,5W

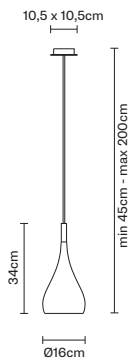

D75 A05
01 White
02 Black

336,00 €

A10209C12

12x16,80 €

E27 1x205W
HSGST η 82,40%

0,026 m³
2,00 Kg
IP20

D75 A05
15 Chrome

358,00 €

A10209C12

12x16,80 €

E27 1x205W
HSGST η 82,40%

0,026 m³
2,00 Kg
IP20

BIJOU D75

Prospero Rasulo

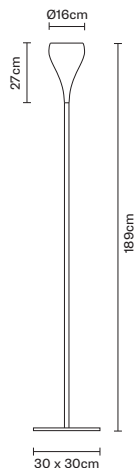

code

price €

bulb code
(not incl.)

bulb price €

electrification

technical info /
accessories incl.

D75 C01
01 White
02 Black

671,00 €

A10209C12

12x16,80 €

E27 1x205W
HSGST η 82,30%

0,040 m³
9,00 Kg
IP20

Variatore luce p. 201 / Light dimmer p. 201

D75 C01
15 Chrome

751,00 €

A10209C12

12x16,80 €

E27 1x205W
HSGST η 82,30%

0,040 m³
9,00 Kg
IP20

Variatore luce p. 201 / Light dimmer p. 201

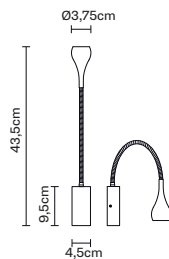

D75 D01
01 White
02 Black

212,00 €



LED 700mA 3W
WHITE 3000K Cri 80

0,003 m³
0,50 Kg
IP20

Interruttore incluso / Switch included

D75 D01
15 Chrome

241,00 €



LED 700mA 3W
WHITE 3000K Cri 80

0,003 m³
0,50 Kg
IP20

Interruttore incluso / Switch included

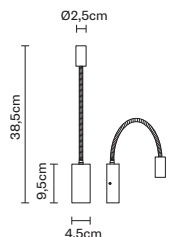

D75 D03
01 White
02 Black

144,00 €



LED 700mA 3W
WHITE 3000K Cri 80

0,003 m³
0,45 Kg
IP20

Interruttore incluso / Switch included

D75 D03
15 Chrome

175,00 €



LED 700mA 3W
WHITE 3000K Cri 80

0,003 m³
0,45 Kg
IP20

Interruttore incluso / Switch included

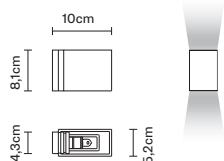

D75 D07
01 White
02 Black

95,00 €

A11003C20

20x3,91 €

G9 1x48W
HSGS

0,003 m³
0,50 Kg
IP44

2 tagli di luce stretti / 2 narrow light beams

D75 D07
15 Chrome

110,00 €

A11003C20

20x3,91 €

G9 1x48W
HSGS

0,003 m³
0,50 Kg
IP44

2 tagli di luce stretti / 2 narrow light beams

BIJOU D75

Prospero Rasulo

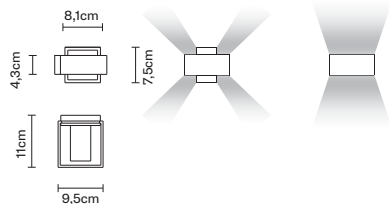

code

price €

bulb code
(not incl.)

bulb price €

electrification

technical info /
accessories incl.

D75 D09
01 White
02 Black

106,00 €

A11003C20

20x3,91 €

G9 1x48W
HSGS

0,003 m³
0,55 Kg
IP44

2 tagli di luce larghi o 4 tagli di luce stretti / 2 large light beams or 4 narrow light beams

D75 D09
15 Chrome

134,00 €

A11003C20

20x3,91 €

G9 1x48W
HSGS

0,003 m³
0,55 Kg
IP44

2 tagli di luce larghi o 4 tagli di luce stretti / 2 large light beams or 4 narrow light beams

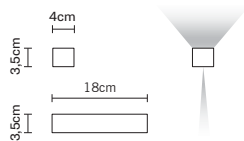

D75 D11
01 White
02 Black

106,00 €

A11502C20

20x6,25 €

R7s (78 mm) 1x80W
HDG

0,003 m³
0,50 Kg
IP20

1 tagli di luce largo sopra e taglio di luce stretto sotto / 1 large light beams on the top and 1 narrow light beams underside

D75 D13
15 Chrome

143,00 €

A11502C20

20x6,25 €

R7s (78 mm) 1x80W
HDG

0,003 m³
0,50 Kg
IP20

1 tagli di luce largo sopra e taglio di luce stretto sotto / 1 large light beams on the top and 1 narrow light beams underside

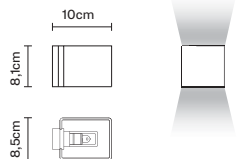

D75 D15
01 White
02 Black

101,00 €

A11003C20

20x3,91 €

G9 1x48W
HSGS

0,003 m³
0,55 Kg
IP44

2 tagli di luce larghi / 2 large light beams

D75 D15
15 Chrome

119,00 €

A11003C20

20x3,91 €

G9 1x48W
HSGS

0,003 m³
0,55 Kg
IP44

2 tagli di luce larghi / 2 large light beams

BINARIO D39

Prospero Rasulo

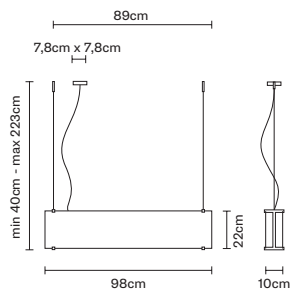

code

price €

bulb code
(not incl.)

bulb price €

electrification

technical info /
accessories incl.

D39 A03
00 Transparent

671,00 €

A10502C04

4x10,35 €

G5 2x39W
FD η 70,00%

0,080 m³
8,50 Kg
IP20

D39 A09
00 Transparent

832,00 €

A10502C04

4x10,35 €

G5 2x39W
FD η 70,00%

0,080 m³
8,50 Kg
IP20

BINARIO D39

Prospero Rasulo

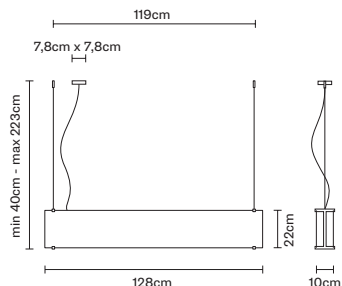

code

price €

bulb code
(not incl.)

bulb price €

electrification

technical info /
accessories incl.

D39 A05
00 Transparent

738,00 €

A10503C04 4x9,18 €

G5 2x54W
FD η 70,00%

0,080 m³
10,27 Kg
IP20

D39 A11
00 Transparent

900,00 €

A10503C04 4x9,18 €

G5 2x54W
FD η 70,00%

0,080 m³
10,27 Kg
IP20

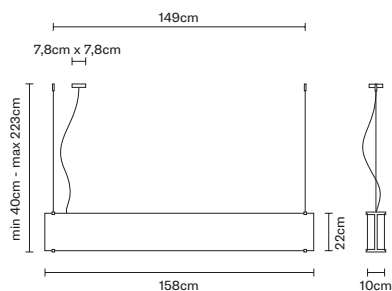

D39 A07
00 Transparent

974,00 €

A10504C04 4x9,57 €

G5 2x80W
FD η 70,00%

0,123 m³
11,80 Kg
IP20

D39 A13
00 Transparent

1.254,00 €

A10504C04 4x9,57 €

G5 2x80W
FD η 70,00%

0,123 m³
11,80 Kg
IP20

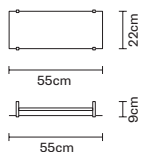

D39 D03
00 Transparent

448,00 €

A11601C10 10x9,96 €

2G11 2x36W
FSD η 53,30%

0,037 m³
4,53 Kg
IP20

BOOMY F29

Vittorio Massimo

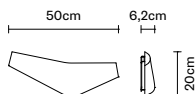

code

price €

bulb code
(not incl.)

bulb price €

electrification

technical info /
accessories incl.

F29 D01
01 White

439,00 €

LED

LED 18W-120°
WHITE 3000K Cri 80

0,012 m³
3,00 Kg
IP20

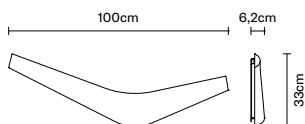

F29 D03
01 White

659,00 €

LED

LED 36W-120°
WHITE 3000K Cri 80

0,035 m³
5,00 Kg
IP20

CLOUDY F21

Mathieu Lehanneur

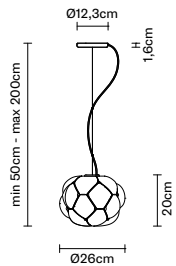

NEW!

F21 A03
71 Translucent white

price €
345,00 €

bulb code
(not incl.)

A10222C10

bulb price €
10x4,69 €

electrification
E27 1x77W
HSGSA

technical info /
accessories incl.

0,120 m³
6,00 Kg
IP20

A10212C10

10x13,98 €

E27 1X15W
FBG

F21 A01
71 Translucent white

price €
439,00 €



LED 1x8,7W
WHITE 3000K Cri 80

0,120 m³
6,00 Kg
IP20

NEW!

F21 A51
71 Translucent white

price €
439,00 €



LED 1x8,7W
WHITE 2700K Cri 80

0,120 m³
6,00 Kg
IP20

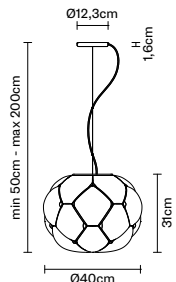

NEW!

F21 A05
71 Translucent white

price €
494,00 €

A10208C12

12x16,41 €

E27 1x150W
HSGST

0,150 m³
8,50 Kg
IP20

A10218C10

10x23,63 €

E27 1X30W
FBT

F21 A02
71 Translucent white

price €
659,00 €



LED 1x24W
WHITE 3000K Cri 80

0,150 m³
8,50 Kg
IP20

NEW!

F21 A52
71 Translucent white

price €
659,00 €



LED 1x24W
WHITE 2700K Cri 80

0,150 m³
8,50 Kg
IP20

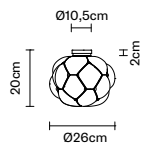

NEW!

F21 E03
71 Translucent white

price €
286,00 €

A10222C10

10x4,69 €

E27 1x77W
HSGSA

0,120 m³
6,00 Kg
IP40

A10212C10

10x13,98 €

E27 1X15W
FBG

F21 E01
71 Translucent white

price €
472,00 €



LED 1x8,7W
WHITE 3000K Cri 80

0,120 m³
6,00 Kg
IP40

NEW!

F21 E51
71 Translucent white

price €
472,00 €



LED 1x8,7W
WHITE 2700K Cri 80

0,120 m³
6,00 Kg
IP40

CLOUDY F21

Mathieu Lehanneur

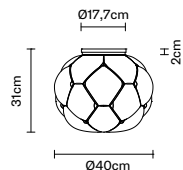

	code	price €	bulb code (not incl.)	bulb price €	electrification	technical info / accessories incl.
NEW!	F21 E05 71 Translucent white	435,00 €	A10208C12 	12x16,41 €	E27 1x150W HSGST	0,150 m ³ 8,50 Kg IP40
			A10218C10 	10x23,63 €	E27 1X30W FBT	
	F21 E02 71 Translucent white	703,00 €			LED 1x17,5W WHITE 3000K Cri 80	0,150 m ³ 8,50 Kg IP40
NEW!	F21 E52 71 Translucent white	703,00 €			LED 1x17,5W WHITE 2700K Cri 80	0,150 m ³ 8,50 Kg IP40

CLOVE F22

Dompieri & Pisoni

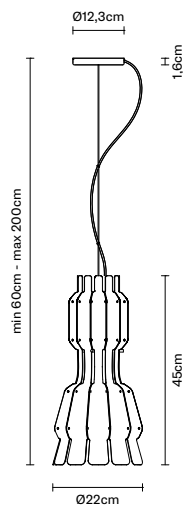

	code	price €	bulb code (not incl.)	bulb price €	electrification	technical info / accessories incl.
	F22 A01 01 White	659,00 €	A10229C01 	1x19,53 €	E27 1x23W FBC	0,120 m ³ 5,50 Kg IP20
			In esaurimento / While stocks last			
	F22 A01 03 Red 21 Anthracite	762,00 €	A10229C01 	1x19,53 €	E27 1x23W FBC	0,120 m ³ 5,50 Kg IP20
			In esaurimento / While stocks last			

CLOVE F22

Dompieri & Pisoni

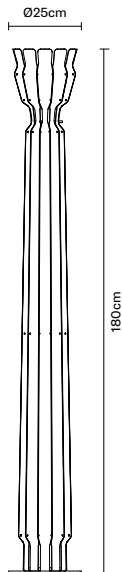

code

price €

bulb code
(not incl.)

bulb price €

electrification

technical info /
accessories incl.

F22 C01
01 White

1.459,00 €

A10218C10

10x23,63 €

E27 2x30W
FBT

0,210 m³
18,00 Kg
IP20

In esaurimento / While stocks last

F22 C01
03 Red
21 Anthracite

1.660,00 €

A10218C10

10x23,63 €

E27 2x30W
FBT

0,210 m³
18,00 Kg
IP20

In esaurimento / While stocks last

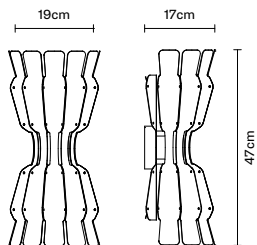

F22 D01
01 White

486,00 €

A10229C01

1x19,53 €

E27 2x23W
FBC

0,120 m³
5,00 Kg
IP20

In esaurimento / While stocks last

F22 D01
03 Red
21 Anthracite

590,00 €

A10229C01

1x19,53 €

E27 2x23W
FBC

0,120 m³
5,00 Kg
IP20

In esaurimento / While stocks last

CRICKET D60

Bridgwell Consulting LTD

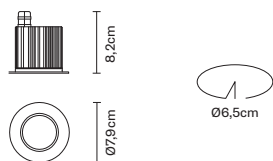

code

price €

bulb code
(not incl.)

bulb price €

electrification

technical info /
accessories incl.

D60 F13
27 Anodize

86,00 €

A10401C10

10x3,71 €

GU4 1x20W
HRGS η 89,20%

0,003 m³
0,35 Kg
IP67

Use parete/terra / For wall/floor

CRICKET D60

Bridgewell Consulting LTD



code	price €	bulb code (not incl.)	bulb price €	electrification	technical info / accessories incl.
D60 F15 60 White 3000K 62 White 2700K	125,00 €			LED 500mA 10W-10° WHITE 3000K Cri 80	0,003 m ³ 0,40 Kg IP67

Uso parete/soffitto/terra. Accessori p. 200-201 - Cassaforma p. 31 / For wall/ceiling/floor. Accessories p. 200-201 - Wallbox p. 31

D60 F16 60 White 3000K 62 White 2700K	125,00 €			LED 500mA 10W-40° WHITE 3000K Cri 80	0,003 m ³ 0,40 Kg IP67
--	----------	--	--	---	---

Uso parete/soffitto/terra. Accessori p. 200-201 - Cassaforma p. 31 / For wall/ceiling/floor. Accessories p. 200-201 - Wallbox p. 31

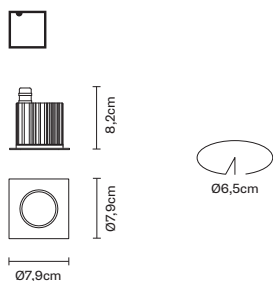

D60 F17 27 Anodize	97,00 €	A10401C10 	10x3,71 €	GU4 1x20W HRGS η 89,20%	0,003 m ³ 0,35 Kg IP67
------------------------------	---------	---------------	-----------	----------------------------	---

Uso parete/terra. Accessori p. 200-201 - Cassaforma p. 31 / For wall/floor. Accessories p. 200-201 - Wallbox p. 31

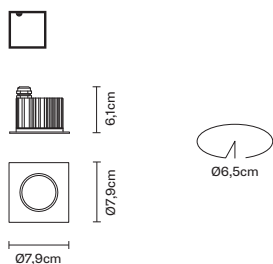

D60 F19 60 White 3000K 62 White 2700K	136,00 €			LED 500mA 10W-10° WHITE 3000K Cri 80	0,003 m ³ 0,40 Kg IP67
--	----------	--	--	---	---

Uso parete/soffitto/terra. Accessori p. 200-201 - Cassaforma p. 31 / For wall/ceiling/floor. Accessories p. 200-201 - Wallbox p. 31

D60 F20 60 White 3000K 62 White 2700K	136,00 €			LED 500mA 10W-40° WHITE 3000K Cri 80	0,003 m ³ 0,40 Kg IP67
--	----------	--	--	---	---

Uso parete/soffitto/terra. Accessori p. 200-201 - Cassaforma p. 31 / For wall/ceiling/floor. Accessories p. 200-201 - Wallbox p. 31

CRICKET D60

Bridgewell Consulting LTD

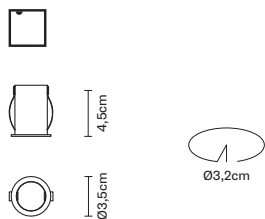

code	price €	bulb code (not incl.)	bulb price €	electrification	technical info / accessories incl.
D60 F21 15 Chrome	29,00 €	A10301C10 	10x0,94 €	G4 1x10W	0,003 m ³ 0,12 Kg IP20
<p>Usò parete/soffitto. Accessori p. 200-201 / For wall/ceiling. Accessories p. 200-201</p>					
D60 F23 60 White 3000K 62 White 2700K	85,00 €			LED 350mA 1W-15° WHITE 3000K Cri 80	0,003 m ³ 0,12 Kg IP20
<p>Usò parete/soffitto. Accessori p. 200-201 / For wall/ceiling. Accessories p. 200-201</p>					
D60 F24 60 White 3000K 62 White 2700K	85,00 €			LED 350mA 1W-30° WHITE 3000K Cri 80	0,003 m ³ 0,12 Kg IP20
<p>Usò parete/soffitto. Accessori p. 200-201 / For wall/ceiling. Accessories p. 200-201</p>					

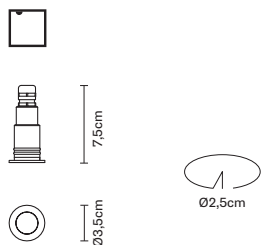



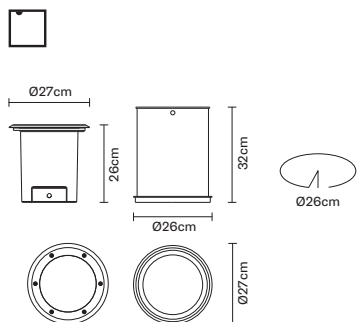

























D60 F25 27 Anodize	54,00 €	A10301C10 	10x0,94 €	G4 1x10W	0,003 m ³ 0,20 Kg IP67
<p>Usò parete/soffitto. Accessori p. 200-201 / For wall/ceiling. Accessories p. 200-201</p>					
D60 F27 60 White 3000K 62 White 2700K	136,00 €			LED 700mA 3W-10° WHITE 3000K Cri 80	0,003 m ³ 0,20 Kg IP67
<p>Usò parete/soffitto/terra. Accessori p. 200-201 - Cassaforma p. 31 / For wall/ceiling/floor. Accessories p. 200-201 - Wallbox p. 31</p>					
D60 F28 60 White 3000K 62 White 2700K	136,00 €			LED 700mA 3W-40° WHITE 3000K Cri 80	0,003 m ³ 0,20 Kg IP67
<p>Usò parete/soffitto/terra. Accessori p. 200-201 - Cassaforma p. 31 / For wall/ceiling/floor. Accessories p. 200-201 - Wallbox p. 31</p>					



D60 F30 35 Polished stainless steel	413,00 €	A10220C01 	1x17,58 €	E27 1x75W IPAR	0,135 m ³ 8,00 Kg IP65
<p>A10227C01 1x101,53 € E27 1x14,5W </p>					
<p>A10218C10 10x23,63 € E27 1x30W FBT</p>					
<p>Cassaforma inclusa / Wallbox included</p>					
D60 F31 35 Polished stainless steel	504,00 €	A11302C01 	1x46,86 €	G12 1x70W MD	0,135 m ³ 8,00 Kg IP65
<p>Cassaforma inclusa / Wallbox included</p>					

CRICKET D60

Bridgewell Consulting LTD

	code	price €	bulb code (not incl.)	bulb price €	electrification	technical info / accessories incl.
  2,65cm  Ø6,3cm	D60 G01 60 White 3000K 62 White 2700K	92,00 €			LED 350mA 7W WHITE 3000K Cri 80	0,003 m ³ 0,35 Kg IP44
<p>Usò parete/soffitto. Accessori p. 200-201 / For wall/ceiling. Accessories p. 200-201</p>						
  6,4cm  Ø6,3cm	D60 G03 11 Polished aluminium	,00 €	A10401C10 	10x3,71 €	GU4 1x20W HRGS η 89,20%	0,003 m ³ 0,35 Kg IP44
<p>Usò parete/soffitto. Accessori p. 200-201 / For wall/ceiling. Accessories p. 200-201</p>						
  6,2cm  Ø6,3cm	D60 G05 60 White 3000K 62 White 2700K	132,00 €			LED 500mA 10W-10° WHITE 3000K Cri 80	0,003 m ³ 0,50 Kg IP44
<p>Usò parete/soffitto. Accessori p. 200-201 / For wall/ceiling. Accessories p. 200-201</p>						
  6,2cm  Ø6,3cm	D60 G06 60 White 3000K 62 White 2700K	132,00 €			LED 500mA 10W-40° WHITE 3000K Cri 80	0,003 m ³ 0,50 Kg IP44
<p>Usò parete/soffitto. Accessori p. 200-201 / For wall/ceiling. Accessories p. 200-201</p>						
  5,7cm  Ø6,3cm	D60 G07 11 Polished aluminium	71,00 €	A10401C10 	10x3,71 €	GU4 1x20W HRGS η 89,20%	0,003 m ³ 0,30 Kg IP20
<p>Usò parete/soffitto. Accessori p. 200-201 / For wall/ceiling. Accessories p. 200-201</p>						
  5,5cm  Ø6,3cm	D60 G09 60 White 3000K 62 White 2700K	99,00 €			LED 500mA 10W-10° WHITE 3000K Cri 80	0,003 m ³ 0,45 Kg IP20
<p>Usò parete/soffitto. Accessori p. 200-201 / For wall/ceiling. Accessories p. 200-201</p>						
  5,5cm  Ø6,3cm	D60 G10 60 White 3000K 62 White 2700K	,00 €			LED 500mA 10W-40° WHITE 3000K Cri 80	0,003 m ³ 0,45 Kg IP20
<p>Usò parete/soffitto. Accessori p. 200-201 / For wall/ceiling. Accessories p. 200-201</p>						

CRICKET D60

Bridgewell Consulting LTD

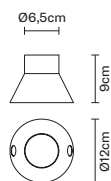

code

price €

bulb code
(not incl.)

bulb price €

electrification

technical info /
accessories incl.

D60 Z05

20,00 €

0,004 m³
0,18 Kg

Cassaforma a pavimento. Per D60F15, D60F16, D60F19, D60F20 / Floor housing. For D60F15, D60F16, D60F19, D60F20

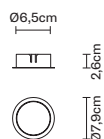

D60 Z07

7,00 €

0,003 m³
0,09 Kg

Cassaforma a soffitto-parete. Per D60F13, D60F15, D60F16, D60F17, D60F19, D60F20 / False ceiling ring. For D60F13, D60F15, D60F16, D60F17, D60F19, D60F20

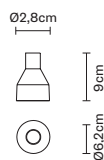

D60 Z09

17,00 €

0,003 m³
0,10 Kg

Cassaforma a pavimento. Per D60F27, D60F28 / Floor housing. For D60F27, D60F28

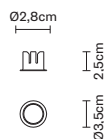

D60 Z11

6,00 €

0,003 m³
0,08 Kg

Cassaforma a soffitto-parete. Per D60F25, D60F27, D60F28 / False ceiling ring. For D60F25, D60F27, D60F28

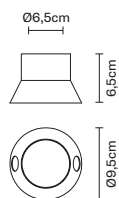

D60 Z13

17,00 €

0,004 m³
0,11 Kg

Cassaforma a pavimento. Per D60F15, D60F16, D60F19, D60F20 / Floor housing. For D60F15, D60F16, D60F19, D60F20

CRIO D81

Giovanni Minelli

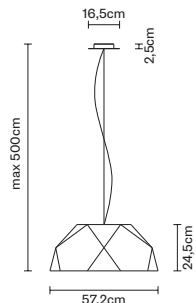

code	price €	bulb code (not incl.)	bulb price €	electrification	technical info / accessories incl.
D81 A01 01 White	1.235,00 €	A10216C10 	10x15,66 €	E27 5x18W FBT	0,144 m ³ 7,20 Kg IP20
D81 A01 48 Dark wood colour 69 Light wood colour	1.651,00 €	A10216C10 	10x15,66 €	E27 5x18W FBT	0,144 m ³ 7,20 Kg IP20

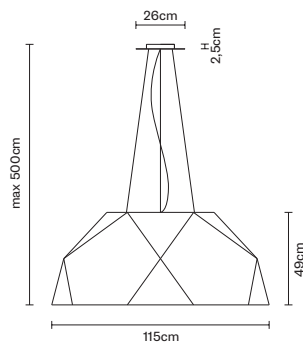

D81 A03 01 White	3.334,00 €	A10217C10 	10x18,36 €	E27 10x22W FBT	0,792 m ³ 24,00 Kg IP20
D81 A03 48 Dark wood colour 69 Light wood colour	4.097,00 €	A10217C10 	10x18,36 €	E27 10x22W FBT	0,792 m ³ 24,00 Kg IP20

CUBETTO D28

Pamio Design

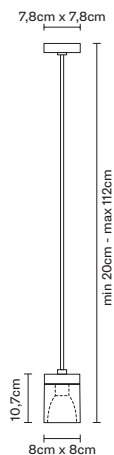

code	price €	bulb code (not incl.)	bulb price €	electrification	technical info / accessories incl.
D28 A01 00 Transparent	228,00 €	A11102C20 	20x4,69 €	GU10 1x50W HAGS η 89,20%	0,028 m ³ 2,95 Kg IP20
		A11105C01 	1x52,72 €	GU10 1x5,5W	
		Struttura cromata lucida / Polished chrome structure			
D28 A01 01 White 02 Black	278,00 €	A11102C20 	20x4,69 €	GU10 1x50W HAGS η 89,20%	0,028 m ³ 2,95 Kg IP20
		A11105C01 	1x52,72 €	GU10 1x5,5W	
		Struttura cromata lucida / Polished chrome structure			
D28 A51 00 Transparent	228,00 €	A11102C20 	20x4,69 €	GU10 1x50W HAGS η 89,20%	0,028 m ³ 2,95 Kg IP20
		A11105C01 	1x52,72 €	GU10 1x5,5W	
		Struttura verniciata bianca opaca / Opaque white painted structure			

CUBETTO D28

Pamio Design

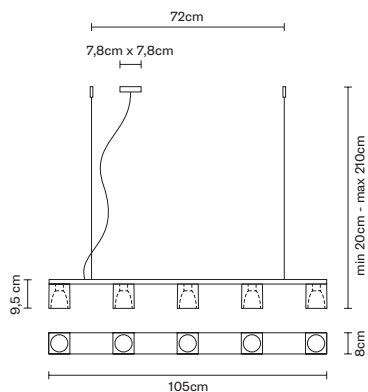

code	price €	bulb code (not incl.)	bulb price €	electrification	technical info / accessories incl.
D28 A05 00 Transparent	778,00 €	A11003C20 	20x3,91 €	G9 5x48W HSGS η 85,10%	0,044 m ³ 9,20 Kg IP20 Struttura cromata lucida / Polished chrome structure
D28 A55 00 Transparent	778,00 €	A11003C20 	20x3,91 €	G9 5x48W HSGS η 85,10%	0,044 m ³ 9,20 Kg IP20 Struttura verniciata bianca opaca / Opaque white painted structure
D28 A06 00 Transparent	778,00 €	A11102C20 	20x4,69 €	GU10 5x50W HAGS η 89,20%	0,044 m ³ 9,20 Kg IP20
		A11105C01 	1x52,72 €	GU10 5x5,5W	
					Struttura cromata lucida / Polished chrome structure
D28 A06 01 White 02 Black	1.021,00 €	A11102C20 	20x4,69 €	GU10 5x50W HAGS η 89,20%	0,044 m ³ 9,20 Kg IP20
		A11105C01 	1x52,72 €	GU10 5x5,5W	
					Struttura cromata lucida / Polished chrome structure
D28 A56 00 Transparent	778,00 €	A11102C20 	20x4,69 €	GU10 5x50W HAGS η 89,20%	0,044 m ³ 9,20 Kg IP20
		A11105C01 	1x52,72 €	GU10 5x5,5W	
					Struttura verniciata bianca opaca / Opaque white painted structure

CUBETTO D28

Pamio Design

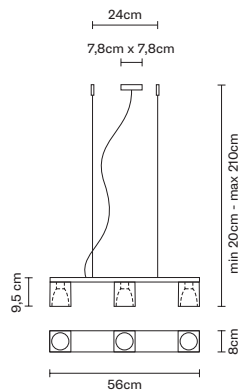

code	price €	bulb code (not incl.)	bulb price €	electrification	technical info / accessories incl.
D28 A13 00 Transparent	457,00 €	A11102C20 	20x4,69 €	GU10 3x50W HAGS η 89,20%	0,036 m ³ 5,55 Kg IP20
		A11105C01 	1x52,72 €	GU10 3x5,5W	
Struttura cromata lucida / Polished chrome structure					
D28 A13 01 White 02 Black	602,00 €	A11102C20 	20x4,69 €	GU10 3x50W HAGS η 89,20%	0,036 m ³ 5,55 Kg IP20
		A11105C01 	1x52,72 €	GU10 3x5,5W	
Struttura cromata lucida / Polished chrome structure					
D28 A63 00 Transparent	457,00 €	A11102C20 	20x4,69 €	GU10 3x50W HAGS η 89,20%	0,036 m ³ 5,55 Kg IP20
		A11105C01 	1x52,72 €	GU10 3x5,5W	
Struttura verniciata bianca opaca / Opaque white painted structure					
D28 A14 00 Transparent	457,00 €	A11003C20 	20x3,91 €	G9 3x48W HSGS η 85,10%	0,036 m ³ 5,55 Kg IP20
Struttura cromata lucida / Polished chrome structure					
D28 A64 00 Transparent	457,00 €	A11003C20 	20x3,91 €	G9 3x48W HSGS η 85,10%	0,036 m ³ 5,55 Kg IP20
Struttura verniciata bianca opaca / Opaque white painted structure					

CUBETTO D28

Pamio Design

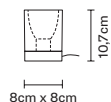

code	price €	bulb code (not incl.)	bulb price €	electrification	technical info / accessories incl.
D28 B01 00 Transparent	126,00 €	A10103C10 	10x8,99 €	E14 1x40W IRP/S	0,004 m ³ 1,40 Kg IP20
		A10111C01 	1x39,56 €	E14 1x3,5W	
		A10105C10 	10x13,20 €	E14 1x6W FBG	
Struttura cromata lucida / Polished chrome structure					
D28 B51 00 Transparent	126,00 €	A10103C10 	10x8,99 €	E14 1x40W IRP/S	0,004 m ³ 1,40 Kg IP20
		A10111C01 	1x39,56 €	E14 1x3,5W	
		A10105C10 	10x13,20 €	E14 1x6W FBG	
Struttura verniciata bianca opaca / Opaque white painted structure					
D28 B03 00 Transparent	126,00 €	A11103C20 	20x6,06 €	GU10 1x75W HAGS η 89,20%	0,004 m ³ 1,40 Kg IP20
		A11105C01 	1x52,72 €	GU10 1x5,5W	
		Struttura cromata lucida / Polished chrome structure			
D28 B03 01 White 02 Black	174,00 €	A11103C20 	20x6,06 €	GU10 1x75W HAGS η 89,20%	0,004 m ³ 1,40 Kg IP20
		A11105C01 	1x52,72 €	GU10 1x5,5W	
		Struttura cromata lucida / Polished chrome structure			
D28 B53 00 Transparent	126,00 €	A11103C20 	20x6,06 €	GU10 1x75W HAGS η 89,20%	0,004 m ³ 1,40 Kg IP20
		A11105C01 	1x52,72 €	GU10 1x5,5W	
		Struttura verniciata bianca opaca / Opaque white painted structure			

CUBETTO D28

Pamio Design

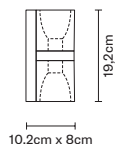

code	price €	bulb code (not incl.)	bulb price €	electrification	technical info / accessories incl.
D28 D01 00 Transparent	271,00 €	A11102C20 	20x4,69 €	GU10 2x50W HAGS η 89,20%	0,005 m ³ 3,20 Kg IP20
		A11105C01 	1x52,72 €	GU10 2x5,5W	
Struttura cromata lucida / Polished chrome structure					
D28 D01 01 White 02 Black	368,00 €	A11102C20 	20x4,69 €	GU10 2x50W HAGS η 89,20%	0,005 m ³ 3,20 Kg IP20
		A11105C01 	1x52,72 €	GU10 2x5,5W	
Struttura cromata lucida / Polished chrome structure					
D28 D51 00 Transparent	271,00 €	A11102C20 	20x4,69 €	GU10 2x50W HAGS η 89,20%	0,005 m ³ 3,20 Kg IP20
		A11105C01 	1x52,72 €	GU10 2x5,5W	
Struttura verniciata bianca opaca / Opaque white painted structure					
D28 D02 00 Transparent	271,00 €	A11003C20 	20x3,91 €	G9 2x48W HSGS η 85,10%	0,005 m ³ 3,20 Kg IP20
		Struttura cromata lucida / Polished chrome structure			
D28 D52 00 Transparent	271,00 €	A11003C20 	20x3,91 €	G9 2x48W HSGS η 85,10%	0,005 m ³ 3,20 Kg IP20
		Struttura verniciata bianca opaca / Opaque white painted structure			

CUBETTO D28

Pamio Design

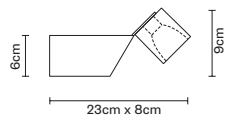



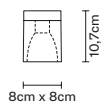





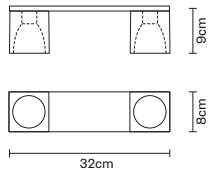



code	price €	bulb code (not incl.)	bulb price €	electrification	technical info / accessories incl.
D28 D03 00 Transparent	301,00 €	A11503C20	20x7,42 €	R7s (78mm) 1x120W HDG η 89,20%	0,012 m ³ 2,50 Kg IP20
		A11102C20	20x4,69 €	GU10 1x50W HAGS	
		A11105C01	1x52,72 €	GU10 1x5,5W	
Struttura cromata lucida / Polished chrome structure					
D28 D03 01 White 02 Black	350,00 €	A11503C20	20x7,42 €	R7s (78mm) 1x120W HDG η 89,20%	0,012 m ³ 2,50 Kg IP20
		A11102C20	20x4,69 €	GU10 1x50W HAGS	
		A11105C01	1x52,72 €	GU10 1x5,5W	
Struttura cromata lucida / Polished chrome structure					
D28 D53 00 Transparent	301,00 €	A11503C20	20x7,42 €	R7s (78mm) 1x120W HDG η 89,20%	0,012 m ³ 2,50 Kg IP20
		A11102C20	20x4,69 €	GU10 1x50W HAGS	
		A11105C01	1x52,72 €	GU10 1x5,5W	
Struttura verniciata bianca opaca / Opaque white painted structure					
D28 E01 00 Transparent	116,00 €	A11102C20	20x4,69 €	GU10 1x50W HAGS η 89,20%	0,004 m ³ 1,36 Kg IP20
		A11105C01	1x52,72 €	GU10 1x5,5W	
		Struttura cromata lucida / Polished chrome structure			
D28 E01 01 White 02 Black	164,00 €	A11102C20	20x4,69 €	GU10 1x50W HAGS η 89,20%	0,004 m ³ 1,36 Kg IP20
		A11105C01	1x52,72 €	GU10 1x5,5W	
		Struttura cromata lucida / Polished chrome structure			
D28 E51 00 Transparent	118,00 €	A11102C20	20x4,69 €	GU10 1x50W HAGS η 89,20%	0,004 m ³ 1,36 Kg IP20
		A11105C01	1x52,72 €	GU10 1x5,5W	
		Struttura verniciata bianca opaca / Opaque white painted structure			



CUBETTO D28

Pamio Design









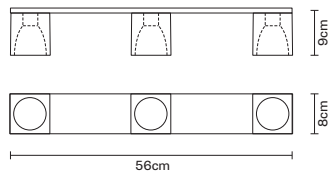

code	price €	bulb code (not incl.)	bulb price €	electrification	technical info / accessories incl.
D28 E02 00 Transparent	222,00 €	A11102C20 	20x4,69 €	GU10 2x50W HAGS η 89,20%	0,037 m ³ 3,50 Kg IP20
		A11105C01  	1x52,72 €	GU10 2x5,5W	
Struttura cromata lucida / Polished chrome structure					
D28 E02 01 White 02 Black	329,00 €	A11102C20 	20x4,69 €	GU10 2x50W HAGS η 89,20%	0,037 m ³ 3,50 Kg IP20
		A11105C01  	1x52,72 €	GU10 2x5,5W	
Struttura cromata lucida / Polished chrome structure					
D28 E52 00 Transparent	224,00 €	A11102C20 	20x4,69 €	GU10 2x50W HAGS η 89,20%	0,037 m ³ 3,50 Kg IP20
		A11105C01  	1x52,72 €	GU10 2x5,5W	
Struttura verniciata bianca opaca / Opaque white painted structure					
D28 E05 00 Transparent	222,00 €	A11003C20 	20x3,91 €	G9 2x48W HSGS η 83,80%	0,037 m ³ 3,50 Kg IP20
		Struttura cromata lucida / Polished chrome structure			
D28 E55 00 Transparent	224,00 €	A11003C20 	20x3,91 €	G9 2x48W HSGS η 83,80%	0,037 m ³ 3,50 Kg IP20
		Struttura verniciata bianca opaca / Opaque white painted structure			

CUBETTO D28

Pamio Design



<i>code</i>	<i>price €</i>	<i>bulb code (not incl.)</i>	<i>bulb price €</i>	<i>electrification</i>	<i>technical info / accessories incl.</i>
D28 E03 00 <i>Transparent</i>	399,00 €	A11102C20 	20x4,69 €	GU10 3x50W HAGS η 89,20%	0,037 m ³ 4,60 Kg IP20
		A11105C01 	1x52,72 €	GU10 3x5,5W	
		Struttura cromata lucida / Polished chrome structure			
D28 E03 01 <i>White</i> 02 <i>Black</i>	545,00 €	A11102C20 	20x4,69 €	GU10 3x50W HAGS η 89,20%	0,037 m ³ 4,60 Kg IP20
		A11105C01 	1x52,72 €	GU10 1x5,5W	
		Struttura cromata lucida / Polished chrome structure			
D28 E53 00 <i>Transparent</i>	399,00 €	A11102C20 	20x4,69 €	GU10 3x50W HAGS η 89,20%	0,037 m ³ 4,60 Kg IP20
		A11105C01 	1x52,72 €	GU10 3x5,5W	
		Struttura verniciata bianca opaca / Opaque white painted structure			
D28 E04 00 <i>Transparent</i>	399,00 €	A11003C20 	20x3,91 €	G9 3x48W HSGS η 83,80%	0,037 m ³ 4,60 Kg IP20
		Struttura cromata lucida / Polished chrome structure			
D28 E54 00 <i>Transparent</i>	399,00 €	A11003C20 	20x3,91 €	G9 3x48W HSGS η 83,80%	0,037 m ³ 4,60 Kg IP20
		Struttura verniciata bianca opaca / Opaque white painted structure			

CUBETTO D28

Pamio Design



<i>code</i>	<i>price €</i>	<i>bulb code (not incl.)</i>	<i>bulb price €</i>	<i>electrification</i>	<i>technical info / accessories incl.</i>
D28 G01 00 Transparent	116,00 €	A10103C10	↑ 10x8,99 €	E14 1x40W IRP/S	0,004 m ³ 1,10 Kg IP20
		A10102C10	↓ 10x5,00 €	E14 1x46W HSGSB	
		A10111C01	↑ 1x39,56 €	E14 1x3,5W (for wall)	
		A10105C10	↑ 10x13,20 €	E14 1x6W FBG (for wall)	
		A10105C10	↓ 10x13,20 €	E14 1x6W FBG (for ceiling)	
Struttura cromata lucida / Polished chrome structure					
D28 G51 00 Transparent	118,00 €	A10103C10	↑ 10x8,99 €	E14 1x40W IRP/S	0,004 m ³ 1,10 Kg IP20
		A10102C10	↓ 10x5,00 €	E14 1x46W HSGSB	
		A10111C01	↑ 1x39,56 €	E14 1x3,5W	
		A10105C10	↑ 10x13,20 €	E14 1x6W FBG (for wall)	
		A10105C10	↓ 10x13,20 €	E14 1x6W FBG (for ceiling)	
Struttura verniciata bianca opaca / Opaque white painted structure					
D28 G02 00 Transparent	116,00 €	A11003C20	20x3,91 €	G9 1x48W HSGS η 84,10%	0,004 m ³ 1,10 Kg IP20
Struttura cromata lucida / Polished chrome structure					
D28 G52 00 Transparent	118,00 €	A11003C20	20x3,91 €	G9 1x48W HSGS η 84,10%	0,004 m ³ 1,10 Kg IP20
Struttura verniciata bianca opaca / Opaque white painted structure					

CUBETTO D28

Pamio Design

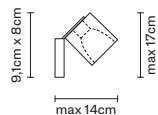

code	price €	bulb code (not incl.)	bulb price €	electrification	technical info / accessories incl.
D28 G03 00 Transparent	156,00 €	A11102C20 	20x4,69 €	GU10 1x50W HAGS η 89,20%	0,004 m ³ 1,60 Kg IP20
		A11105C01 	1x52,72 €	GU10 1x5,5W	
Struttura cromata lucida / Polished chrome structure					
D28 G03 01 White 02 Black	204,00 €	A11102C20 	20x4,69 €	GU10 1x50W HAGS η 89,20%	0,004 m ³ 1,60 Kg IP20
		A11105C01 	1x52,72 €	GU10 1x5,5W	
Struttura cromata lucida / Polished chrome structure					
D28 G53 00 Transparent	157,00 €	A11102C20 	20x4,69 €	GU10 1x50W HAGS η 89,20%	0,004 m ³ 1,60 Kg IP20
		A11105C01 	1x52,72 €	GU10 1x5,5W	
Struttura verniciata bianca opaca / Opaque white painted structure					
NEW! D28 G89 00 Transparent	167,00 €	A11102C20 	20x4,69 €	GU10 1x50W HAGS η 89,20%	0,004 m ³ 1,60 Kg IP20
		A11105C01 	1x52,72 €	GU10 1x5,5W	
Struttura metallica ramata / Copper metal structure					
NEW! D28 G90 00 Transparent	176,00 €	A11102C20 	20x4,69 €	GU10 1x50W HAGS η 89,20%	0,004 m ³ 1,60 Kg IP20
		A11105C01 	1x52,72 €	GU10 1x5,5W	
Struttura metallica ottonata / Brass-plated metal structure					
D28 G04 00 Transparent	156,00 €	A11003C20 	20x3,91 €	G9 1x48W HSGS η 84,10%	0,004 m ³ 1,60 Kg IP20
		Struttura cromata lucida / Polished chrome structure			
D28 G54 00 Transparent	157,00 €	A11003C20 	20x3,91 €	G9 1x48W HSGS η 84,10%	0,004 m ³ 1,60 Kg IP20
		Struttura verniciata bianca opaca / Opaque white painted structure			

CUBETTO D28

Pamio Design

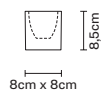

code	price €	bulb code (not incl.)	bulb price €	electrification	technical info / accessories incl.
D28 Z01 00 Transparent	38,00 €				0,004 m ³ 1,29 Kg
D28 Z01 C4 00 Transparent	4x33,00 €				0,006 m ³ 4,80 Kg Confezione 4 pz. / Set 4 pcs.
D28 Z02 01 White 02 Black	82,00 €				0,004 m ³ 1,29 Kg
D28 Z02 C4 01 White 02 Black	4x64,25 €				0,006 m ³ 4,80 Kg Confezione 4 pz. / Set 4 pcs.

CYCLONE F28

Bartek Mejor

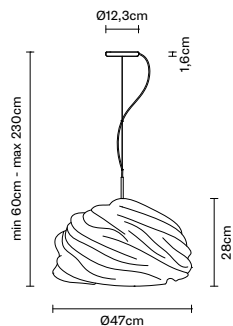

code	price €	bulb code (not incl.)	bulb price €	electrification	technical info / accessories incl.
F28 A01 01 White	539,00 €			LED 1x24W WHITE 3000K Cri 80	0,012 m ³ 8,00 Kg IP20
F28 A51 01 White	539,00 €			LED 1x24W WHITE 2700K Cri 80	0,012 m ³ 8,00 Kg IP20

DIAMOND&SWIRL D82

Bridgewell Consulting LTD

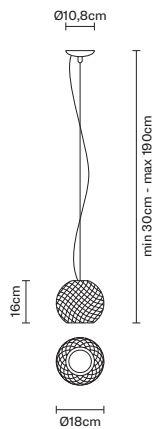

code

D82 A01
00 Transparent

price €

538,00 €

bulb code
(not incl.)

A11004C20

bulb price €

20x3,91 €

electrification

G9 1x60W
HSGS η 88,10%

technical info /
accessories incl.

0,072 m³
4,50 Kg
IP20

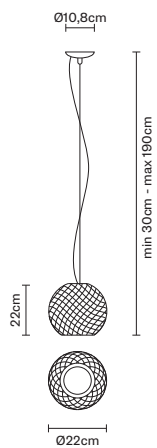

D82 A03
00 Transparent

646,00 €

A11004C20

20x3,91 €

G9 1x60W
HSGS η 88,10%

0,072 m³
5,40 Kg
IP20

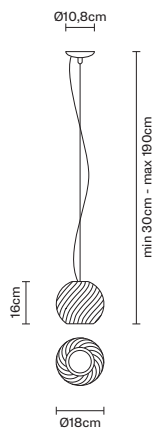

D82 A05
00 Transparent

538,00 €

A11004C20

20x3,91 €

G9 1x60W
HSGS η 88,10%

0,072 m³
4,50 Kg
IP20

DIAMOND&SWIRL D82

Bridgewell Consulting LTD

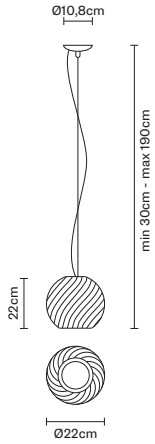

code

D82 A07
00 Transparent

price €

623,00 €

bulb code
(not incl.)

A11004C20

bulb price €

20x3,91 €

electrification

G9 1x60W
HSGS η 88,10%

technical info /
accessories incl.

0,072 m³
5,40 Kg
IP20

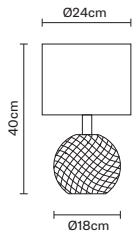

D82 B01
01 White
02 Black

688,00 €

A11004C20

↑ 20x3,91 €

G9 1x60W
HSGS η 88,10%

0,036 m³
2,80 Kg

A11005C20
↓

G9 1x40W
HSGS

IP20

A11009C10
↓

G9 1x9W
FBT

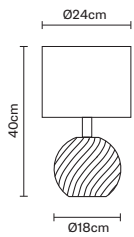

D82 B03
01 White
02 Black

688,00 €

A11004C20

↑ 20x3,91 €

G9 1x60W
HSGS η 88,10%

0,036 m³
2,80 Kg

A11005C20
↓

G9 1x40W
HSGS

IP20

A11009C10
↓

G9 1x9W
FBT

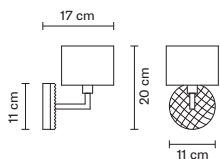

D82 D01
01 White
02 Black

229,00 €

A11004C20

20x3,91 €

G9 1x60W
HSGS η 88,10%

0,009 m³
1,85 Kg

IP20

DIAMOND&SWIRL D82

Bridgewell Consulting LTD

	code	price €	bulb code (not incl.)	bulb price €	electrification	technical info / accessories incl.
	D82 D99 00 Transparent	434,00 €	A11502C20 	20x6,25 €	R7s (78 mm) 1x80W HDG	0,020 m ³ 2,80 Kg IP20
	D82 D98 00 Transparent	419,00 €	A11502C20 	20x6,25 €	R7s (78 mm) 1x80W HDG	0,020 m ³ 2,80 Kg IP20
	NEW! D82 E01 00 Transparent	476,00 €	A11004C20 	20x3,91 €	G9 1x60W HSGS η 88,10%	0,030 m ³ 4,30 Kg IP20
	NEW! D82 E03 00 Transparent	585,00 €	A11004C20 	20x3,91 €	G9 1x60W HSGS η 88,10%	0,030 m ³ 5,50 Kg IP20
	NEW! D82 E05 00 Transparent	476,00 €	A11004C20 	20x3,91 €	G9 1x60W HSGS η 88,10%	0,030 m ³ 3,50 Kg IP20

DIAMOND&SWIRL D82

Bridgewell Consulting LTD

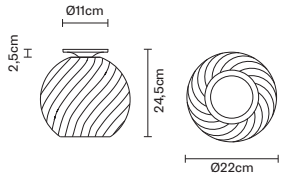

code

price €

bulb code
(not incl.)

bulb price €

electrification

technical info /
accessories incl.

D82 E07
00 Transparent

562,00 €

A11004C20

20x3,91 €

G9 1x60W
HSGS η 88,10%

0,030 m³
4,50 Kg
IP20

DONO D65

Alessandra Baldereschi

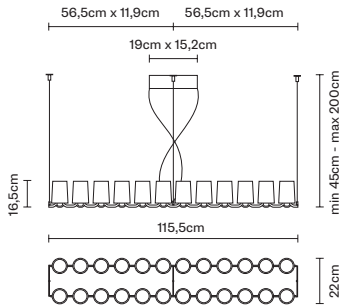

code

price €

bulb code
(not incl.)

bulb price €

electrification

technical info /
accessories incl.

D65 A01
00 Transparent

2.011,00 €

A10301C10

10x0,94 €

G4 12V 24x10W
HSGS η 79,60%

0,116 m³
24,70 Kg
IP20

Bicchieri rigati. In esaurimento (extra 20%) / Striped glass. While stocks last (extra 20%)

D65 A02
00 Transparent

1.909,00 €

A10301C10

10x0,94 €

G4 12V 24x10W
HSGS η 79,60%

0,116 m³
24,70 Kg
IP20

Bicchieri fantasia. In esaurimento (extra 20%) / Patterned glass. While stocks last (extra 20%)



D65 B01
00 Transparent

105,00 €

A11004C20

20x3,91 €

G9 1x60W
HSGS

0,012 m³
1,25 Kg
IP20

Bicchieri rigati. In esaurimento (extra 20%) / Striped glass. While stocks last (extra 20%)

D65 B02
00 Transparent

99,00 €

A11004C20

20x3,91 €

G9 1x60W
HSGS

0,012 m³
1,25 Kg
IP20

Bicchieri fantasia. In esaurimento (extra 20%) / Patterned glass. While stocks last (extra 20%)



D65 Z01 C6
00 Transparent

6x13,85 €

0,003 m³
0,86 Kg

Bicchieri rigati "Whisky" 6 pz. In esaurimento / "Whisky" striped glass 6 pz. While stocks last



D65 Z02 C6
00 Transparent

6x29,35 €

0,019 m³
2,90 Kg

Bicchieri rigati "Vino" 6 pz. In esaurimento / "Wine" striped glass 6 pz. While stocks last

DONO D65

Alessandra Baldereschi



code
—
D65 Z03 C6
00 Transparent

price €
—
6x34,15 €

bulb code
(not incl.)

bulb price €

electrification

technical info / accessories incl.

0,019 m³
3,24 Kg

Bicchieri rigati "Acqua" 6 pz. In esaurimento / "Water" striped glass 6 pz. While stocks last



D65 Z04 C6
00 Transparent

6x39,00 €

0,022 m³
3,70 Kg

Bicchieri rigati "Drink" 6 pz. In esaurimento / "Drink" striped glass 6 pz. While stocks last



D65 Z11 C6
00 Transparent

6x12,00 €

0,023 m³
0,66 Kg

Bicchieri fantasia "Whisky" 6 pz. In esaurimento / "Whisky" patterned glass 6 pz. While stocks last



D65 Z12 C6
00 Transparent

6x24,65 €

0,019 m³
2,71 Kg

Bicchieri fantasia "Vino" 6 pz. In esaurimento / "Wine" patterned glass 6 pz. While stocks last



D65 Z13 C6
00 Transparent

6x29,35 €

0,019 m³
3,25 Kg

Bicchieri fantasia "Acqua" 6 pz. In esaurimento / "Water" patterned glass 6 pz. While stocks last



D65 Z14 C6
00 Transparent

6x34,15 €

0,022 m³
3,67 Kg

Bicchieri fantasia "Drink" 6 pz. In esaurimento / "Drink" patterned glass 6 pz. While stocks last

ENCK F17

Francesco Lucchese

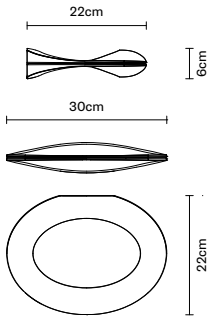

code	price €	bulb code (not incl.)	bulb price €	electrification	technical info / accessories incl.
F17 G01 01 White	169,00 €	A11507C20 20x7,03 € 	20x7,03 €	R7s (118mm) 1x230W HDG	0,010 m ³ 1,63Kg IP20
		A11506C20 20x6,25 € 			
F17 G01 12 Gold	303,00 €	A11507C20 20x7,03 € 	20x7,03 €	R7s (118mm) 1x230W HDG	0,010 m ³ 1,63Kg IP20
		A11506C20 20x6,25 € 			
F17 G01 15 Chrome	251,00 €	A11507C20 20x7,03 € 	20x7,03 €	R7s (118mm) 1x230W HDG	0,010 m ³ 1,63Kg IP20
		A11506C20 20x6,25 € 			
F17 G03 01 White	364,00 €			LED 4x4,5W WHITE 3000K Cri 80	0,010 m ³ 1,63Kg IP40
F17 G03 12 Gold	499,00 €			LED 4x4,5W WHITE 3000K Cri 80	0,010 m ³ 1,63Kg IP40
F17 G03 15 Chrome	447,00 €			LED 4x4,5W WHITE 3000K Cri 80	0,010 m ³ 1,63Kg IP40

EYES F34

Matali Crasset

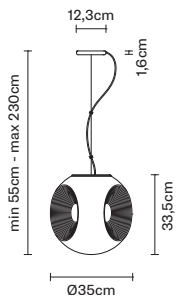

NEW!

code	price €	bulb code (not incl.)	bulb price €	electrification	technical info / accessories incl.
F34 A01 00 Transparent 01 White	359,00 €	A10229C01 	1x19,53 €	E27 1x23W FBC	0,120 m ³ 4,10Kg IP20

EYES F34

Matali Crasset

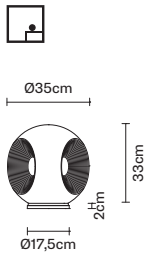

NEW!

code
—
F34 B01
00 Transparent
01 White

price €
—
328,00 €

bulb code (not incl.)
—
A10229C01

bulb price €
—
1x19,53 €

electrification
—
E27 1x23W
FBC

technical info / accessories incl.
—
0,120 m³
4,20Kg
IP40

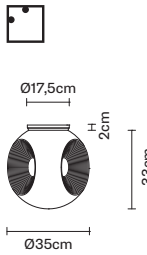

NEW!

code
—
F34 G01
00 Transparent
01 White

price €
—
321,00 €

bulb code (not incl.)
—
A10229C01

bulb price €
—
1x19,53 €

electrification
—
E27 1x23W
FBC

technical info / accessories incl.
—
0,120 m³
4,00Kg
IP40

FACTORY D83

Tiziano Maffione

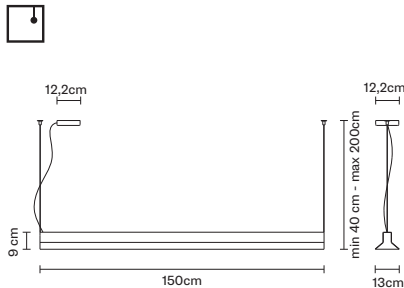

code
—
D83 A01
01 White
02 Black

price €
—
467,00 €

bulb code (not incl.)
—
A10504C04

bulb price €
—
4x9,57 €

electrification
—
G5 2x80W
FD

technical info / accessories incl.
—
0,090 m³
7,50 Kg
IP20

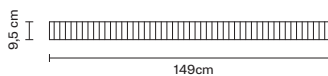

code
—
D83 Z01

price €
—
179,00 €

technical info / accessories incl.
—
0,030 m³
0,50 Kg

FACTORY D83

Tiziano Maffione

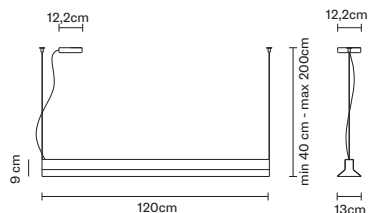

code

price €

bulb code
(not incl.)

bulb price €

electrification

technical info /
accessories incl.

D83 A03
01 White
02 Black

359,00 €

A10503C04

4x9,18 €

G5 2x54W
FD

0,080 m³
6,50 Kg
IP20

D83 Z03

143,00 €

0,030 m³
0,50 Kg



FARETTI D27

Luca Scacchetti

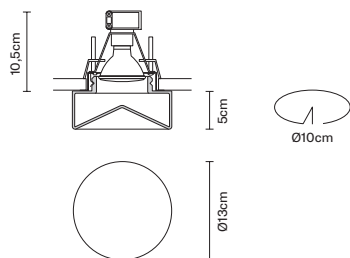

code

price €

bulb code
(not incl.)

bulb price €

electrification

technical info /
accessories incl.

D27 F17
00 Transparent

65,00 €

A11103C20

20x6,06 €

GU10 1x75W
HAGS η 87,80%

0,009 m³
0,80 Kg
IP20
IP44

A11105C01

1x52,72 €

GU10 1x5,5W

D27 F18
00 Transparent

65,00 €

A10704C10

10x5,67 €

GU5,3 1x50W
HRGS η 91,60%

0,009 m³
0,80 Kg
IP20
IP44

A10705C01

1x47,65 €

GU5,3 1x4W

Accessori p. 200-201 / Accessories p. 200-201

D27 F47
00 Transparent

121,00 €



LED 700mA 14W-40°
WHITE 3000K Cri 80

0,009 m³
0,80 Kg
IP20
IP44

Accessori p. 200-201 / Accessories p. 200-201

NEW!

D27 F85
00 Transparent

121,00 €



LED 700mA 14W-40°
WHITE 2700K Cri 80

0,009 m³
0,80 Kg
IP20
IP44

Accessori p. 200-201 / Accessories p. 200-201

FARETTI D27

Luca Scacchetti

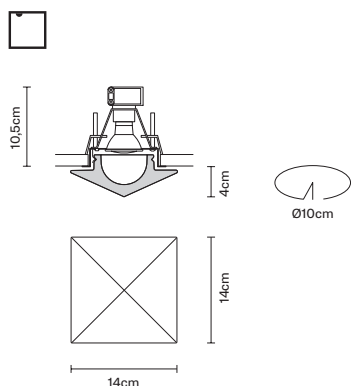

code	price €	bulb code (not incl.)	bulb price €	electrification	technical info / accessories incl.
D27 F07 00 Transparent 01 White	104,00 €	A11102C20 	20x4,69 €	GU10 1x50W HAGS η 97,70%	0,009 m ³ 1,10 Kg IP20 IP44
		A11105C01 	1x52,72 €	GU10 1x5,5W	
D27 F08 00 Transparent 01 White	104,00 €	A10704C10 	10x5,67 €	GU5,3 1x50W HRGS η 91,70%	0,009 m ³ 1,10 Kg IP20 IP44
		A10705C01 	1x47,65 €	GU5,3 1x4W	
Accessori p. 200-201 / Accessories p. 200-201					
D27 F37 00 Transparent 01 White	164,00 €			LED 700mA 14W-40° WHITE 3000K Cri 80	0,009 m ³ 1,10 Kg IP20 IP44
Accessori p. 200-201 / Accessories p. 200-201					
D27 F70 00 Transparent 01 White	164,00 €			LED 700mA 14W-40° WHITE 2700K Cri 80	0,009 m ³ 1,10 Kg IP20 IP44
Accessori p. 200-201 / Accessories p. 200-201					

NEW!

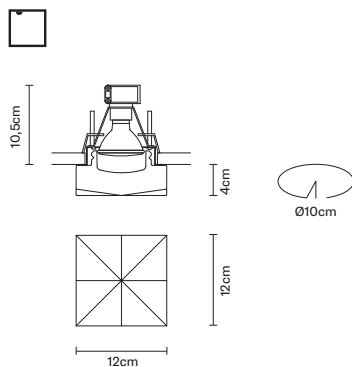

D27 F28 00 Transparent 01 White	104,00 €	A11102C20 	20x4,69 €	GU10 1x50W HAGS η 97,70%	0,009 m ³ 1,25 Kg IP20 IP44
		A11105C01 	1x52,72 €	GU10 1x5,5W	
D27 F29 00 Transparent 01 White	104,00 €	A10704C10 	10x5,67 €	GU5,3 1x50W HRGS η 91,70%	0,009 m ³ 1,25 Kg IP20 IP44
		A10705C01 	1x47,65 €	GU5,3 1x4W	
Accessori p. 200-201 / Accessories p. 200-201					
D27 F49 00 Transparent 01 White	164,00 €			LED 700mA 14W-40° WHITE 3000K Cri 80	0,009 m ³ 1,25 Kg IP20 IP44
Accessori p. 200-201 / Accessories p. 200-201					
D27 F71 00 Transparent 01 White	164,00 €			LED 700mA 14W-40° WHITE 2700K Cri 80	0,009 m ³ 1,25 Kg IP20 IP44
Accessori p. 200-201 / Accessories p. 200-201					

NEW!

FARETTI D27

Luca Scacchetti

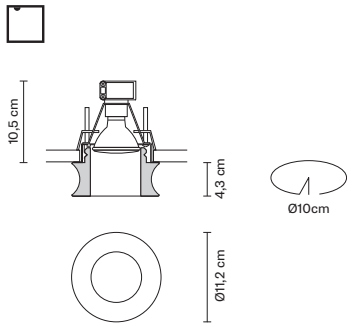

code	price €	bulb code (not incl.)	bulb price €	electrification	technical info / accessories incl.
D27 F51 00 Transparent 01 White	104,00 €	A11103C20 	20x6,06 €	GU10 1x75W HAGS η 97,10%	0,009 m ³ 1,06 Kg IP20
		A11105C01 	1x52,72 €	GU10 1x5,5W	
D27 F52 00 Transparent 01 White	104,00 €	A10704C10 	10x5,67 €	GU5,3 1x50W HRGS η 95,90%	0,009 m ³ 1,06 Kg IP20
		A10705C01 	1x47,65 €	GU5,3 1x4W	
Accessori p. 200-201 / Accessories p. 200-201					
D27 F54 00 Transparent 01 White	164,00 €			LED 700mA 14W-40° WHITE 3000K Cri 80	0,009 m ³ 1,06 Kg IP20
Accessori p. 200-201 / Accessories p. 200-201					
D27 F72 00 Transparent 01 White	164,00 €			LED 700mA 14W-40° WHITE 2700K Cri 80	0,009 m ³ 1,06 Kg IP20
Accessori p. 200-201 / Accessories p. 200-201					
D27 F03 00 Transparent 01 White	104,00 €	A11102C20 	20x4,69 €	GU10 1x50W HAGS η 95,50%	0,009 m ³ 0,90 Kg IP20 IP44
		A11105C01 	1x52,72 €	GU10 1x5,5W	
D27 F04 00 Transparent 01 White	104,00 €	A10704C10 	10x5,67 €	GU5,3 1x50W HRGS η 82,40%	0,009 m ³ 0,90 Kg IP20 IP44
		A10705C01 	1x47,65 €	GU5,3 1x4W	
Accessori p. 200-201 / Accessories p. 200-201					
D27 F33 00 Transparent 01 White	164,00 €			LED 700mA 14W-40° WHITE 3000K Cri 80	0,009 m ³ 1,06 Kg IP20 IP44
Accessori p. 200-201 / Accessories p. 200-201					
D27 F73 00 Transparent 01 White	164,00 €			LED 700mA 14W-40° WHITE 2700K Cri 80	0,009 m ³ 1,06 Kg IP20 IP44
Accessori p. 200-201 / Accessories p. 200-201					

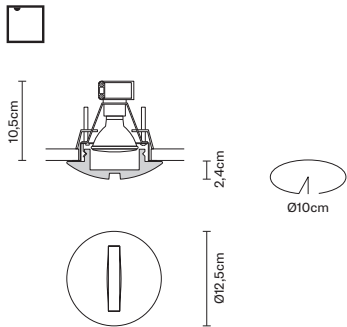

FARETTI D27

Luca Scacchetti

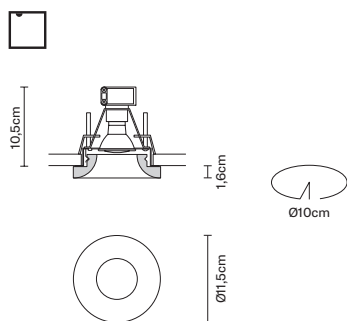

code	price €	bulb code (not incl.)	bulb price €	electrification	technical info / accessories incl.
D27 F05 C1 01 White	10x56,40 €	A11102C20	20x4,69 €	GU10 1x50W HAGS η 96,80%	0,009 m ³ 0,65 Kg IP20
		A11105C01	1x52,72 €	GU10 1x5,5W	
D27 F06 C1 01 White	10x56,40 €	A10704C10	10x5,67 €	GU5,3 1x50W HRGS η 95,70%	0,009 m ³ 0,65 Kg IP20
		A10705C01	1x47,65 €	GU5,3 1x4W	
Accessori p. 200-201 / Accessories p. 200-201					
NEW! D27 F35 01 White	164,00 €			LED 700mA 14W-40° WHITE 3000K Cri 80	0,009 m ³ 1,06 Kg IP20
Accessori p. 200-201 / Accessories p. 200-201					
NEW! D27 F74 01 White	164,00 €			LED 700mA 14W-40° WHITE 2700K Cri 80	0,009 m ³ 1,06 Kg IP20
Accessori p. 200-201 / Accessories p. 200-201					
D27 F13 00 Transparent	104,00 €	A11103C20	20x6,06 €	GU10 1x75W HAGS η 98,00%	0,009 m ³ 1,10 Kg IP20
		A11105C01	1x52,72 €	GU10 1x5,5W	
D27 F14 00 Transparent	104,00 €	A10704C10	10x5,67 €	GU5,3 1x50W HRGS η 90,20%	0,009 m ³ 1,10 Kg IP20
		A10705C01	1x47,65 €	GU5,3 1x4W	
Accessori p. 200-201 / Accessories p. 200-201					
D27 F43 00 Transparent	164,00 €			LED 700mA 14W-40° WHITE 3000K Cri 80	0,009 m ³ 1,10 Kg IP20
Accessori p. 200-201 / Accessories p. 200-201					
NEW! D27 F75 00 Transparent	164,00 €			LED 700mA 14W-40° WHITE 2700K Cri 80	0,009 m ³ 1,10 Kg IP20
Accessori p. 200-201 / Accessories p. 200-201					

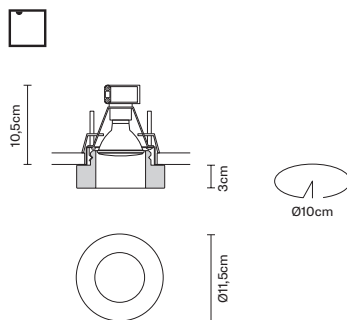

FARETTI D27

Luca Scacchetti

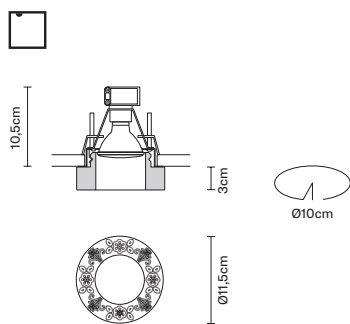

code	price €	bulb code (not incl.)	bulb price €	electrification	technical info / accessories incl.
NEW! D27 F77 00 Transparent	104,00 €	A11103C20 	20x6,06 €	GU10 1x75W HAGS η 98,00%	0,009 m ³ 1,10 Kg IP20
		A11105C01 	1x52,72 €	GU10 1x5,5W	
NEW! D27 F78 00 Transparent	104,00 €	A10704C10 	10x5,67 €	GU5,3 1x50W HRGS η 90,20%	0,009 m ³ 1,10 Kg IP20
		A10705C01 	1x47,65 €	GU5,3 1x4W	
		Accessori p. 200-201 / Accessories p. 200-201			
NEW! D27 F79 00 Transparent	164,00 €			LED 700mA 14W-40° WHITE 3000K Cri 80	0,009 m ³ 1,10 Kg IP20
		Accessori p. 200-201 / Accessories p. 200-201			
NEW! D27 F80 00 Transparent	164,00 €			LED 700mA 14W-40° WHITE 2700K Cri 80	0,009 m ³ 1,10 Kg IP20
		Accessori p. 200-201 / Accessories p. 200-201			

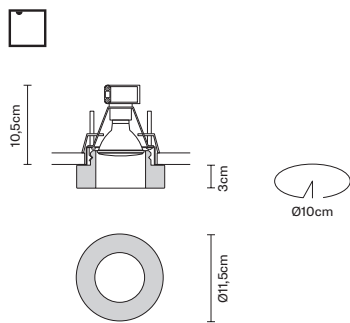

D27 F15 35 Polished stainless steel	127,00 €	A11103C20 	20x6,06 €	GU10 1x75W HAGS η 87,80%	0,009 m ³ 1,10 Kg IP20
		A11105C01 	1x52,72 €	GU10 1x5,5W	
D27 F16 35 Polished stainless steel	127,00 €	A10704C10 	10x5,67 €	GU5,3 1x50W HRGS η 86,60%	0,009 m ³ 1,10 Kg IP20
		A10705C01 	1x47,65 €	GU5,3 1x4W	
		Accessori p. 200-201 / Accessories p. 200-201			
D27 F44 35 Polished stainless steel	192,00 €			LED 700mA 14W-40° WHITE 3000K Cri 80	0,009 m ³ 1,10 Kg IP20
		Accessori p. 200-201 / Accessories p. 200-201			
NEW! D27 F76 35 Polished stainless steel	192,00 €			LED 700mA 14W-40° WHITE 2700K Cri 80	0,009 m ³ 1,10 Kg IP20
		Accessori p. 200-201 / Accessories p. 200-201			

FARETTI D27

Luca Scacchetti

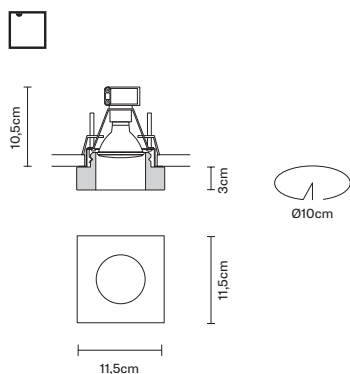

code	price €	bulb code (not incl.)	bulb price €	electrification	technical info / accessories incl.
D27 F09 00 Transparent	104,00 €	A11103C20	20x6,06 €	GU10 1x75W HAGS η 83,80%	0,009 m ³ 1,10 Kg IP20
		A11105C01	1x52,72 €	GU10 1x5,5W	
D27 F10 00 Transparent	104,00 €	A10704C10	10x5,67 €	GU5,3 1x50W HRGS η 78,50%	0,009 m ³ 1,10 Kg IP20
		A10705C01	1x47,65 €	GU5,3 1x4W	
Accessori p. 200-201 / Accessories p. 200-201					
D27 F39 00 Transparent	164,00 €			LED 700mA 14W-40° WHITE 3000K Cri 80	0,009 m ³ 1,10 Kg IP20
Accessori p. 200-201 / Accessories p. 200-201					
D27 F86 00 Transparent	164,00 €			LED 700mA 14W-40° WHITE 2700K Cri 80	0,009 m ³ 1,10 Kg IP20
Accessori p. 200-201 / Accessories p. 200-201					
D27 F66 00 Transparent	104,00 €	A11103C20	20x6,06 €	GU10 1x75W HAGS η 83,80%	0,009 m ³ 1,10 Kg IP20
		A11105C01	1x52,72 €	GU10 1x5,5W	
D27 F67 00 Transparent	104,00 €	A10704C10	10x5,67 €	GU5,3 1x50W HRGS η 78,50%	0,009 m ³ 1,10 Kg IP20
		A10705C01	1x47,65 €	GU5,3 1x4W	
Accessori p. 200-201 / Accessories p. 200-201					
D27 F68 00 Transparent	164,00 €			LED 700mA 14W-40° WHITE 3000K Cri 80	0,009 m ³ 1,10 Kg IP20
Accessori p. 200-201 / Accessories p. 200-201					
D27 F69 00 Transparent	164,00 €			LED 700mA 14W-40° WHITE 2700K Cri 80	0,009 m ³ 1,10 Kg IP20
Accessori p. 200-201 / Accessories p. 200-201					

FARETTI D27

Luca Scacchetti

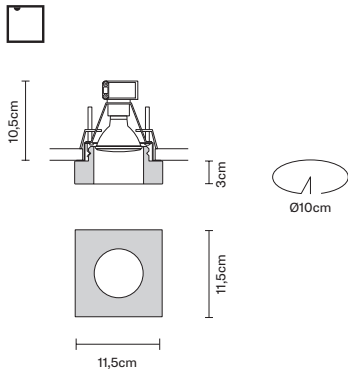

code	price €	bulb code (not incl.)	bulb price €	electrification	technical info / accessories incl.
D27 F11 35 Polished stainless steel	127,00 €	A11103C20	20x6,06 €	GU10 1x75W HAGS η 83,30%	0,009 m ³ 1,10 Kg IP20
		A11105C01	1x52,72 €	GU10 1x5,5W	
D27 F12 35 Polished stainless steel	127,00 €	A10704C10	10x5,67 €	GU5,3 1x50W HRGS η 85,00%	0,009 m ³ 1,10 Kg IP20
		A10705C01	1x47,65 €	GU5,3 1x4W	
Accessori p. 200-201 / Accessories p. 200-201					
D27 F40 35 Polished stainless steel	192,00 €			LED 700mA 14W-40° WHITE 3000K Cri 80	0,009 m ³ 1,10 Kg IP20
Accessori p. 200-201 / Accessories p. 200-201					
D27 F81 35 Polished stainless steel	192,00 €			LED 700mA 14W-40° WHITE 2700K Cri 80	0,009 m ³ 1,10 Kg IP20
Accessori p. 200-201 / Accessories p. 200-201					
D27 F56 00 Transparent 01 White	104,00 €	A11103C20	20x6,06 €	GU10 1x75W HAGS η 98,00%	0,009 m ³ 1,10 Kg IP20
		A11105C01	1x52,72 €	GU10 1x5,5W	
D27 F57 00 Transparent 01 White	104,00 €	A10704C10	10x5,67 €	GU5,3 1x50W HRGS η 90,20%	0,009 m ³ 1,10 Kg IP20
		A10705C01	1x47,65 €	GU5,3 1x4W	
Accessori p. 200-201 / Accessories p. 200-201					
D27 F59 00 Transparent 01 White	164,00 €			LED 700mA 14W-40° WHITE 3000K Cri 80	0,009 m ³ 1,10 Kg IP20
Accessori p. 200-201 / Accessories p. 200-201					
D27 F82 00 Transparent 01 White	164,00 €			LED 700mA 14W-40° WHITE 2700K Cri 80	0,009 m ³ 1,10 Kg IP20
Accessori p. 200-201 / Accessories p. 200-201					

FARETTI D27

Luca Scacchetti

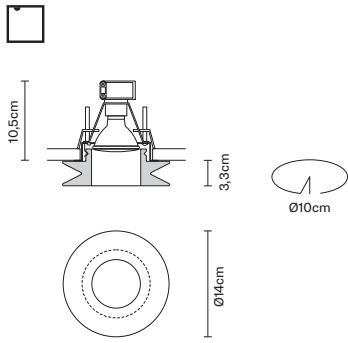

code	price €	bulb code (not incl.)	bulb price €	electrification	technical info / accessories incl.
D27 F01 00 Transparent 01 White	127,00 €	A11103C20	20x6,06 €	GU10 1x75W HAGS η 97,10%	0,009 m ³ 1,06 Kg IP20
		A11105C01	1x52,72 €	GU10 1x5,5W	
D27 F02 00 Transparent 01 White	127,00 €	A10704C10	10x5,67 €	GU5,3 1x50W HRGS η 95,90%	0,009 m ³ 1,06 Kg IP20
		A10705C01	1x47,65 €	GU5,3 1x4W	
Accessori p. 200-201 / Accessories p. 200-201					
D27 F31 00 Transparent 01 White	192,00 €			LED 700mA 14W-40° WHITE 3000K Cri 80	0,009 m ³ 1,06 Kg IP20
Accessori p. 200-201 / Accessories p. 200-201					
D27 F83 00 Transparent 01 White	192,00 €			LED 700mA 14W-40° WHITE 2700K Cri 80	0,009 m ³ 1,06 Kg IP20
Accessori p. 200-201 / Accessories p. 200-201					
D27 F61 00 Transparent 01 White	104,00 €	A11103C20	20x6,06 €	GU10 1x75W HAGS η 98,00%	0,009 m ³ 1,10 Kg IP20
		A11105C01	1x52,72 €	GU10 1x5,5W	
D27 F62 00 Transparent 01 White	104,00 €	A10704C10	10x5,67 €	GU5,3 1x50W HRGS η 90,20%	0,009 m ³ 1,10 Kg IP20
		A10705C01	1x47,65 €	GU5,3 1x4W	
Accessori p. 200-201 / Accessories p. 200-201					
D27 F64 00 Transparent 01 White	164,00 €			LED 700mA 14W-40° WHITE 3000K Cri 80	0,009 m ³ 1,10 Kg IP20
Accessori p. 200-201 / Accessories p. 200-201					
D27 F84 00 Transparent 01 White	164,00 €			LED 700mA 14W-40° WHITE 2700K Cri 80	0,009 m ³ 1,10 Kg IP20
Accessori p. 200-201 / Accessories p. 200-201					

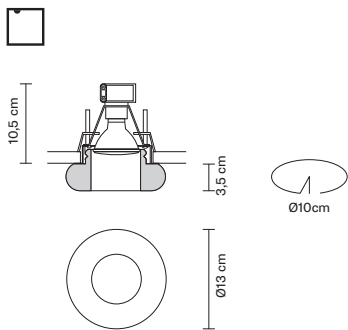

NEW!

NEW!

FARETTI D27

Luca Scacchetti

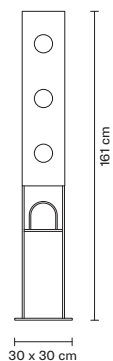

code	price €	bulb code (not incl.)	bulb price €	electrification	technical info / accessories incl.
D27 Z01 01 White	** €				0,215 m ³ 26,95 Kg
		In omaggio con l'acquisto di Free of charge upon purchasing D27F0100 D27F0101 D27F0300 D27F0301 D27F0501 D27F0700 D27F0701 D27F0900 D27F1135 D27F1300 D27F1535 D27F1700 A11102C20 A11103C20 + N° 38 pezzi D27 a scelta + N° 38 D27 art-item at your choice			

FLOW D87

Nicola Design

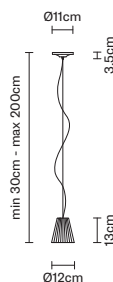

code	price €	bulb code (not incl.)	bulb price €	electrification	technical info / accessories incl.
D87 A01 00 Transparent	221,00 €	A11003C20 	20x3,91 €	G9 1x48W HSGS	0,027 m ³ 3,90 Kg IP20
D87 A01 01 White	232,00 €	A11003C20 	20x3,91 €	G9 1x48W HSGS	0,027 m ³ 3,90 Kg IP20
D87 A01 15 Chrome	238,00 €	A11003C20 	20x3,91 €	G9 1x48W HSGS	0,027 m ³ 3,90 Kg IP20

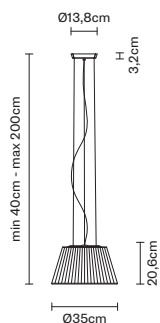

D87 A04 00 Transparent	466,00 €	A10208C12 	12x16,41 €	E27 1x150W HSGST	0,133 m ³ 11,00 Kg IP20
		A10217C10 	10x18,36 €	E27 1x22W FBT	
D87 A03 01 White	494,00 €	A10208C12 	12x16,41 €	E27 1x150W HSGST	0,133 m ³ 11,00 Kg IP20
		A10217C10 	10x18,36 €	E27 1x22W FBT	
D87 A03 15 Chrome	557,00 €	A10208C12 	12x16,41 €	E27 1x150W HSGST	0,133 m ³ 11,00 Kg IP20
		A10217C10 	10x18,36 €	E27 1x22W FBT	

FLOW D87

Nicola Design

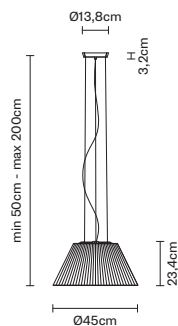

code	price €	bulb code (not incl.)	bulb price €	electrification	technical info / accessories incl.
D87 A06 00 <i>Transparent</i>	535,00 €	A10208C12 	12x16,41 €	E27 1x150W HSGST	0,144 m ³ 15,00 Kg IP20
		A10217C10 	10x18,36 €	E27 1x22W FBT	
D87 A05 01 <i>White</i>	574,00 €	A10208C12 	12x16,41 €	E27 1x150W HSGST	0,144 m ³ 15,00 Kg IP20
		A10217C10 	10x18,36 €	E27 1x22W FBT	
D87 A05 15 <i>Chrome</i>	661,00 €	A10208C12 	12x16,41 €	E27 1x150W HSGST	0,144 m ³ 15,00 Kg IP20
		A10217C10 	10x18,36 €	E27 1x22W FBT	

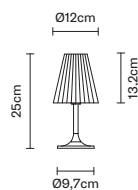

D87 B01 00 <i>Transparent</i>	158,00 €	A11003C20 	20x3,91 €	G9 1x48W HSGS	0,009 m ³ 2,60 Kg IP20
		A11003C20 	20x3,91 €	G9 1x48W HSGS	0,009 m ³ 2,60 Kg IP20
D87 B01 01 <i>White</i>	168,00 €	A11003C20 	20x3,91 €	G9 1x48W HSGS	0,009 m ³ 2,60 Kg IP20
		A11003C20 	20x3,91 €	G9 1x48W HSGS	0,009 m ³ 2,60 Kg IP20
D87 B01 15 <i>Chrome</i>	176,00 €	A11003C20 	20x3,91 €	G9 1x48W HSGS	0,009 m ³ 2,60 Kg IP20
		A11003C20 	20x3,91 €	G9 1x48W HSGS	0,009 m ³ 2,60 Kg IP20

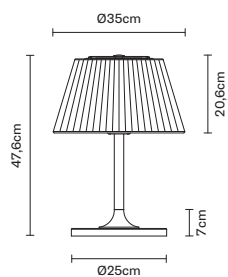

D87 B04 00 <i>Transparent</i>	658,00 €	A10207C12 	12x16,41 €	E27 1x100W HSGST	0,036 m ³ 13,50 Kg IP20
		A10216C10 	10x15,66 €	E27 1x18W FBT	
D87 B03 01 <i>White</i>	686,00 €	A10207C12 	12x16,41 €	E27 1x100W HSGST	0,036 m ³ 13,50 Kg IP20
		A10216C10 	10x15,66 €	E27 1x18W FBT	
D87 B03 15 <i>Chrome</i>	749,00 €	A10207C12 	12x16,41 €	E27 1x100W HSGST	0,036 m ³ 13,50 Kg IP20
		A10216C10 	10x15,66 €	E27 1x18W FBT	

FLOW D87

Nicola Design

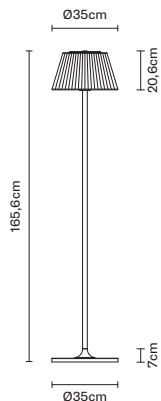

code	price €	bulb code (not incl.)	bulb price €	electrification	technical info / accessories incl.
D87 C02 00 <i>Transparent</i>	809,00 €	A10208C12 	12x16,41 €	E27 1x150W HSGST	0,087 m ³ 20,00 Kg IP20
		A10217C10 	10x18,36 €	E27 1x22W FBT	
D87 C01 01 <i>White</i>	838,00 €	A10208C12 	12x16,41 €	E27 1x150W HSGST	0,087 m ³ 20,00 Kg IP20
		A10217C10 	10x18,36 €	E27 1x22W FBT	
D87 C01 15 <i>Chrome</i>	900,00 €	A10208C12 	12x16,41 €	E27 1x150W HSGST	0,087 m ³ 20,00 Kg IP20
		A10217C10 	10x18,36 €	E27 1x22W FBT	

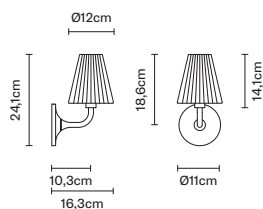

D87 D01 00 <i>Transparent</i>	158,00 €	A11003C20 	20x3,91 €	G9 1x48W HSGS	0,009 m ³ 2,60 Kg IP20
D87 D01 01 <i>White</i>	168,00 €	A11003C20 	20x3,91 €	G9 1x48W HSGS	0,009 m ³ 2,60 Kg IP20
D87 D01 15 <i>Chrome</i>	176,00 €	A11003C20 	20x3,91 €	G9 1x48W HSGS	0,009 m ³ 2,60 Kg IP20

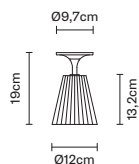

D87 E01 00 <i>Transparent</i>	158,00 €	A11003C20 	20x3,91 €	G9 1x48W HSGS	0,009 m ³ 2,50 Kg IP20
D87 E01 01 <i>White</i>	168,00 €	A11003C20 	20x3,91 €	G9 1x48W HSGS	0,009 m ³ 2,50 Kg IP20
D87 E01 15 <i>Chrome</i>	176,00 €	A11003C20 	20x3,91 €	G9 1x48W HSGS	0,009 m ³ 2,50 Kg IP20

GIRO F30

Formfjord

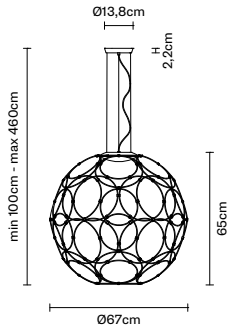

code	price €	bulb code (not incl.)	bulb price €	electrification	technical info / accessories incl.
F30 A01 01 White	649,00 €	⊕	LED	LED 1x24W WHITE 3000K Cri 80	0,015 m ³ 2,50 Kg IP20
NEW! F30 A51 01 White	649,00 €	⊕	LED	LED 1x24W WHITE 2700K Cri 80	0,015 m ³ 2,50 Kg IP20
F30 A01 21 Anthracite	704,00 €	⊕	LED	LED 1x24W WHITE 3000K Cri 80	0,015 m ³ 2,50 Kg IP20
NEW! F30 A51 21 Anthracite	704,00 €	⊕	LED	LED 1x24W WHITE 2700K Cri 80	0,015 m ³ 2,50 Kg IP20

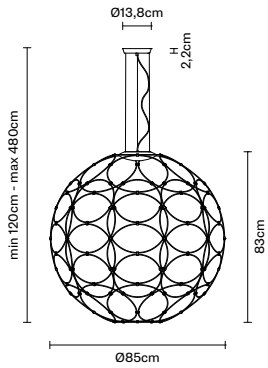

F30 A03 01 White	726,00 €	⊕	LED	LED 1x24W WHITE 3000K Cri 80	0,015 m ³ 2,90 Kg IP20
NEW! F30 A53 01 White	726,00 €	⊕	LED	LED 1x24W WHITE 2700K Cri 80	0,015 m ³ 2,90 Kg IP20
F30 A03 21 Anthracite	814,00 €	⊕	LED	LED 1x24W WHITE 3000K Cri 80	0,015 m ³ 2,90 Kg IP20
NEW! F30 A53 21 Anthracite	814,00 €	⊕	LED	LED 1x24W WHITE 2700K Cri 80	0,015 m ³ 2,90 Kg IP20

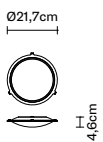

F30 Z01 01 White 21 Anthracite	246,00 €	⊕	LED	LED 1x24W WHITE 3000K Cri 80	0,019 m ³ 1,15 Kg IP20
		Blocco luce / Light part			
F30 Z51 01 White 21 Anthracite	246,00 €	⊕	LED	LED 1x24W WHITE 2700K Cri 80	0,019 m ³ 1,15 Kg IP20
		Blocco luce / Light part			

GIUNCO F14

Marc Sadler

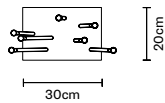
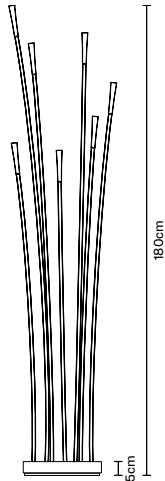

code

price €

bulb code
(not incl.)

bulb price €

electrification

technical info /
accessories incl.

F14 C01
01 White

1.115,00 €



LED 7x3,5W
WHITE 3000K Cri 80

0,160 m³
8,50 Kg
IP20

Diffusori fissi / Fixed diffusers

F14 C03
01 White

1.115,00 €



LED 7x3,5W
WHITE 3000K Cri 80

0,160 m³
8,50 Kg
IP65

Diffusori fissi / Fixed diffusers

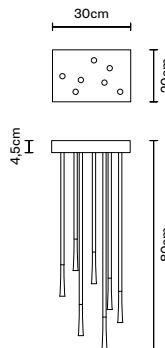

F14 E01
01 White

1.036,00 €



LED 7x3,5W
WHITE 3000K Cri 80

0,080 m³
2,20 Kg
IP20

Diffusori fissi / Fixed diffusers

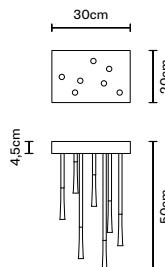

F14 E03
01 White

1.031,00 €



LED 7x3,5W
WHITE 3000K Cri 80

0,080 m³
2,00 Kg
IP20

Diffusori fissi / Fixed diffusers

GLU F31

Pellegrini+Mengato Design

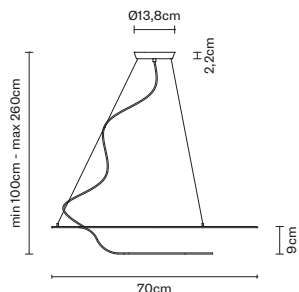

code

price €

bulb code
(not incl.)

bulb price €

electrification

technical info /
accessories incl.

F31 A01
01 White

583,00 €



LED 2x24W
WHITE 3000K Cri 80

0,130 m³
3,60 Kg
IP20

NEW!

F31 A51
01 White

583,00 €



LED 2x24W
WHITE 2700K Cri 80

0,130 m³
3,60 Kg
IP20

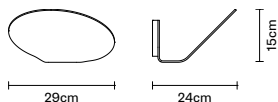

F31 D01
01 White

264,00 €



LED 1x24W
WHITE 3000K Cri 80

0,017 m³
2,50 Kg
IP40

NEW!

F31 D51
01 White

264,00 €



LED 1x24W
WHITE 2700K Cri 80

0,017 m³
2,50 Kg
IP40

HUNGRY D76

Ali Siahvoshi

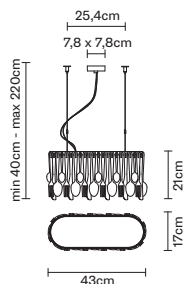

code

price €

bulb code
(not incl.)

bulb price €

electrification

technical info /
accessories incl.

D76 A01
15 Chrome

769,00 €

A10103C10

10x8,99 €

E14 3x40W
IRP/S η 95,60%

0,035 m³
5,20 Kg
IP20

A10111C01

1x39,56 €

E14 3x3,5W

A10105C10

10x13,20 €

E14 3x6W
FBG

HUNGRY D76

Ali Siahvoshi

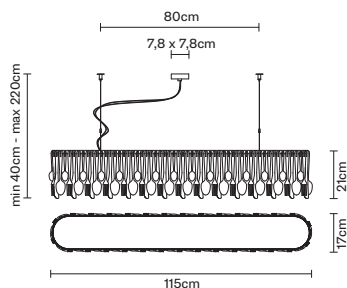

code

price €

bulb code
(not incl.)

bulb price €

electrification

technical info /
accessories incl.

D76 A03
15 Chrome

1.313,00 €

A10203C10

10x6,25 €

E27 5x60W
IRA/S η 95,60%

0,091 m³
11,65 Kg
IP20

A10225C01

1x74,20 €

E27 5x9,5W

A10211C10

10x12,50 €

E27 5x11W
FBT

JAZZ D52

Pamio Design

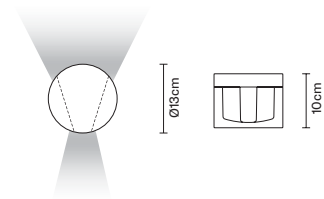

code

price €

bulb code
(not incl.)

bulb price €

electrification

technical info /
accessories incl.

D52 G01
00 Transparent

223,00 €

A11004C20

20x3,91 €

G9 1x60W
HSGS η 78,90%

0,009 m³
2,20 Kg
IP20

2 tagli luce larghi / 2 large light beams

D52 G02
00 Transparent

281,00 €

LED 8,7W
WHITE 3000K Cri 80

0,009 m³
2,20 Kg
IP20

2 tagli luce larghi / 2 large light beams

D52 G52
00 Transparent

281,00 €

LED 8,7W
WHITE 2700K Cri 80

0,009 m³
2,20 Kg
IP20

2 tagli luce larghi / 2 large light beams

D52 G03
00 Transparent

257,00 €

A11004C20

20x3,91 €

G9 1x60W
HSGS η 78,90%

0,009 m³
2,20 Kg
IP44

2 tagli luce larghi / 2 large light beams

JAZZ D52

Pamio Design

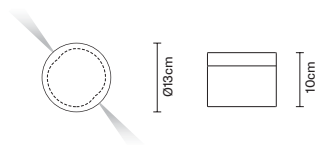

	code	price €	bulb code (not incl.)	bulb price €	electrification	technical info / accessories incl.	
	D52 G05 00 Transparent	158,00 €	A11004C20 	20x3,91 €	G9 1x60W HSGS η 83,50%	0,009 m ³ 1,70 Kg IP20	
			A11003C20 	20x3,91 €	G9 1x48W HSGS		
			2 tagli luce stretti / 2 narrow light beams				
NEW!	D52 G06 00 Transparent	215,00 €		LED	LED 8,7W WHITE 3000K Cri 80	0,009 m ³ 1,70 Kg IP20	
			2 tagli luce stretti / 2 narrow light beams				
NEW!	D52 G56 00 Transparent	215,00 €		LED	LED 8,7W WHITE 2700K Cri 80	0,009 m ³ 1,70 Kg IP20	
			2 tagli luce stretti / 2 narrow light beams				

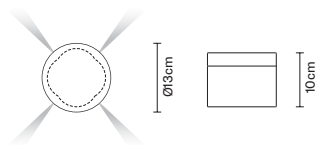

	D52 G07 00 Transparent	158,00 €	A11004C20 	20x3,91 €	G9 1x60W HSGS η 83,50%	0,009 m ³ 1,80 Kg IP20	
			A11003C20 	20x3,91 €	G9 1x48W HSGS		
			4 tagli luce stretti / 4 narrow light beams				
NEW!	D52 G08 00 Transparent	215,00 €		LED	LED 8,7W WHITE 3000K Cri 80	0,009 m ³ 1,70 Kg IP20	
			4 tagli luce stretti / 4 narrow light beams				
NEW!	D52 G58 00 Transparent	215,00 €		LED	LED 8,7W WHITE 2700K Cri 80	0,009 m ³ 1,70 Kg IP20	
			4 tagli luce stretti / 4 narrow light beams				

KONE D66

Paolo De Lucchi - Enrica Frezza



code

price €

bulb code
(not incl.)

bulb price €

electrification

technical info /
accessories incl.

D66 A01
15 Chrome

458,00 €

A10209C12

12x16,80 €

E27 1x205W
HSGST η 56,50%

0,050 m³
2,75 Kg
IP20

In esaurimento / While stocks last



D66 A03
15 Chrome

300,00 €

A10205C15

15x12,10 €

E27 1x100W
HAGS η 100,00%

0,012 m³
1,75 Kg
IP20

A10228C01

1x131,21 €

E27 1x9,5W

In esaurimento / While stocks last

KWARK F13

Karim Rashid

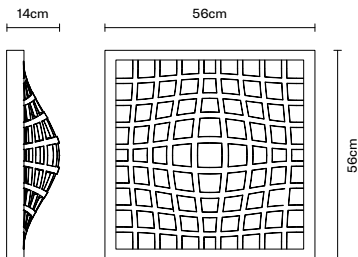

code

price €

bulb code
(not incl.)

bulb price €

electrification

technical info /
accessories incl.

F13 G01
01 White
02 Black
30 Metallic
grey

1.470,00 €

LED

LED 26W-120°
WHITE 3000K Cri 85

0,125 m³
10,50 Kg
IP20

LAMAS F24

Lagranja Design

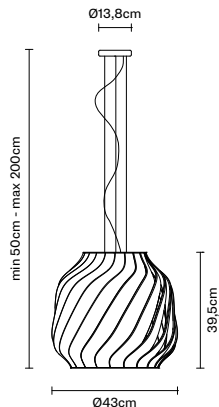

code

price €

bulb code
(not incl.)

bulb price €

electrification

technical info /
accessories incl.

F24 A01
01 White

574,00 €

A10209C12

12x16,80 €

E27 1x205W
HSGST

0,180 m³
8,50 Kg
IP20

A10218C10

10x23,63 €

E27 1x30W
FBT

NEW!

F24 A03
01 White

684,00 €



LED 1x24W
WHITE 3000K Cri 80

0,180 m³
8,50 Kg
IP20

NEW!

F24 A53
01 White

684,00 €



LED 1x24W
WHITE 2700K Cri 80

0,180 m³
8,50 Kg
IP20

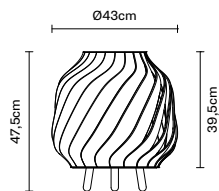

F24 B01
01 White

541,00 €

A10209C12

12x16,80 €

E27 1x205W
HSGST

0,180 m³
8,50 Kg
IP20

A10218C10

10x23,63 €

E27 1x30W
FBT

ELECTRONIC DIMMER

NEW!

F24 B03
01 White

651,00 €



LED 1x24W
WHITE 3000K Cri 80

0,180 m³
8,50 Kg
IP20

ELECTRONIC DIMMER

NEW!

F24 B53
01 White

651,00 €



LED 1x24W
WHITE 2700K Cri 80

0,180 m³
8,50 Kg
IP20

ELECTRONIC DIMMER

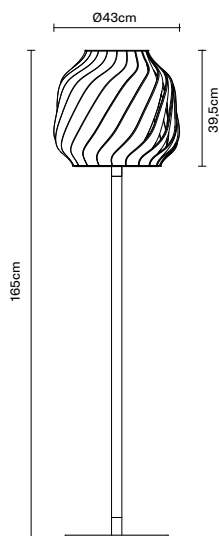

F24 C01
01 White

805,00 €

A10209C12

12x16,80 €

E27 1x205W
HSGST

0,450 m³
15,00 Kg
IP20

A10218C10

10x23,63 €

E27 1x30W
FBT

ELECTRONIC DIMMER

NEW!

F24 C03
01 White

915,00 €



LED 1x24W
WHITE 3000K Cri 80

0,450 m³
15,00 Kg
IP20

ELECTRONIC DIMMER

NEW!

F24 C53
01 White

915,00 €













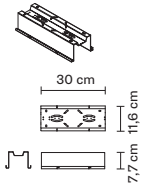

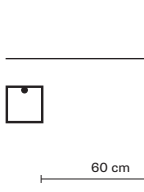

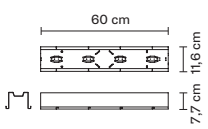
LED 1x24W
WHITE 2700K Cri 80

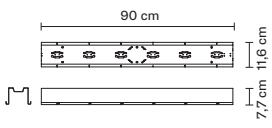
0,450 m³
15,00 Kg
IP20

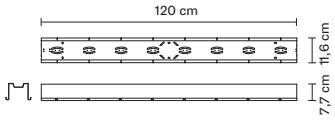
ELECTRONIC DIMMER

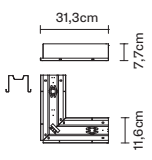
LAMINIS F33

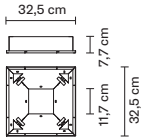
FE Design

	code	price €	bulb code (not incl.)	bulb price €	electrification	technical info / accessories incl.
 	NEW! F33 M11 63 Painted gray	98,00 €	A11102C20 	20x4,69 €	GU10 Starter 2x50W HAGS	0,010 m ³ 1,50 Kg IP20
			Starter / Starter			
 	NEW! F33 M12 63 Painted gray	67,00 €	A11102C20 	20x4,69 €	GU10 2x50W HAGS	0,010 m ³ 1,50 Kg IP20
 	NEW! F33 M13 63 Painted gray	125,00 €	A11102C20 	20x4,69 €	GU10 4x50W HAGS	0,015 m ³ 2,50 Kg IP20
 	NEW! F33 M14 63 Painted gray	180,00 €	A11102C20 	20x4,69 €	GU10 6x50W HAGS	0,020 m ³ 3,00 Kg IP20
 	NEW! F33 M15 63 Painted gray	221,00 €	A11102C20 	20x4,69 €	GU10 8x50W HAGS	0,020 m ³ 3,50 Kg IP20
 	NEW! F33 M16 63 Painted gray	197,00 €	A11102C20 	20x4,69 €	GU10 Starter 3x50W HAGS	0,020 m ³ 2,20 Kg IP20
 	NEW! F33 M17 63 Painted gray	251,00 €	A11102C20 	20x4,69 €	GU10 Starter 4x50W HAGS	0,020 m ³ 3,00 Kg IP20

LAMINIS F33

FE Design

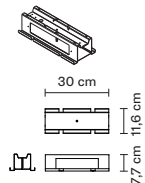

NEW!

F33 M01
63 Painted gray

157,00 €

bulb code
(not incl.)

bulb price €

electrification

technical info /
accessories incl.

0,010 m³
1,50 Kg
IP20

Starter. Barretta LED non incl. p. 75. Alim. non incl. p. 200-201 / Starter. LED bar not incl. p. 75. Alim. not incl. p. 200-201

NEW!

F33 M02
63 Painted gray

267,00 €

0,010 m³
1,50 Kg
IP20

Starter. Barretta LED non incl. p. 75. 1 Alim. Incluso. Altre dim. su richiesta / Starter. LED bar not incl. p. 75. 1 Alim. Included. Other dim. by request

NEW!

F33 M03
63 Painted gray

377,00 €

0,010 m³
1,50 Kg
IP20

Starter. Barretta LED non incl. p. 75. 2 Alim. Incluso. Altre dim. su richiesta / Starter. LED bar not incl. p. 75. 2 Alim. Included. Other dim. by request

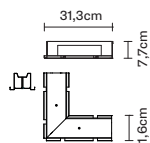

NEW!

F33 M06
63 Painted gray

490,00 €

0,020 m³
2,20 Kg
IP20

Starter. Barretta LED non incl. p. 75. 2 Alim. Incluso. Altre dim. su richiesta / Starter. LED bar not incl. p. 75. 2 Alim. Included. Other dim. by request

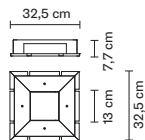

NEW!

F33 M07
63 Painted gray

790,00 €

0,020 m³
3,00 Kg
IP20

Starter. Barretta LED non incl. p. 75. 4 Alim. Incluso. Altre dim. su richiesta / Starter. LED bar not incl. p. 75. 4 Alim. Included. Other dim. by request

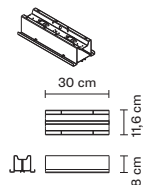

NEW!

F33 M22
63 Painted gray

67,00 €

0,010 m³
1,50 Kg
IP20

Strip LED non incl. p. 75. Alim. non incl. p. 200-201 / Strip LED not incl. p. 75. Alim. not incl. p. 200-201

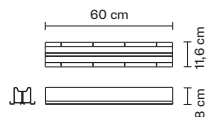

NEW!

F33 M23
63 Painted gray









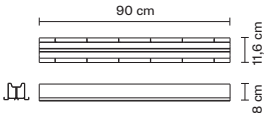

125,00 €

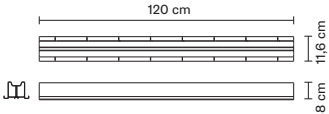
0,015 m³
2,50 Kg
IP20

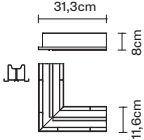
Strip LED non incl. p. 75. Alim. non incl. p. 200-201 / Strip LED not incl. p. 75. Alim. not incl. p. 200-201

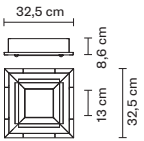
LAMINIS F33

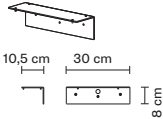
FE Design

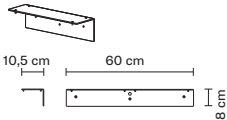
	code	price €	bulb code (not incl.)	bulb price €	electrification	technical info / accessories incl.
 	NEW! F33 M24 63 Painted gray	180,00 €				0,020 m ³ 3,00 Kg IP20 Strip LED non incl. p. 75. Alim. non incl. p. 200-201 / Strip LED not incl. p. 75. Alim. not incl. p. 200-201
 	NEW! F33 M25 63 Painted gray	221,00 €				0,020 m ³ 3,50 Kg IP20 Strip LED non incl. p. 75. Alim. non incl. p. 200-201 / Strip LED not incl. p. 75. Alim. not incl. p. 200-201
 	NEW! F33 M26 63 Painted gray	197,00 €				0,020 m ³ 2,20 Kg IP20 Strip LED non incl. p. 75. Alim. non incl. p. 200-201 / Strip LED not incl. p. 75. Alim. not incl. p. 200-201
 	NEW! F33 M27 63 Painted gray	251,00 €				0,020 m ³ 3,00 Kg IP20 Strip LED inclusa. Alim. Incluso / Strip LED included. Alim. Included
 	NEW! F33 Z02 63 Painted gray	33,00 €				0,010 m ³ 1,00 Kg Accessorio parete per L1/2 GU10 - L1/2 LED bar - L1/2 LED strip / wall accessory for L1/2 GU10 - L1/2 LED bar - L1/2 LED strip
 	NEW! F33 Z03 63 Painted gray	50,00 €				0,015 m ³ 1,50 Kg Accessorio parete per L1/2 GU10 - L1/2 LED bar - L1/2 LED strip / wall accessory for L1/2 GU10 - L1/2 LED bar - L1/2 LED strip











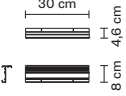

LAMINIS F33

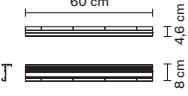
FE Design

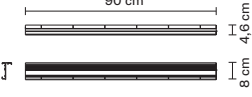
	code	price €	bulb code (not incl.)	bulb price €	electrification	technical info / accessories incl.
	NEW! F33 Z04 63 Painted gray	85,00 €				0,020 m ³ 2,00 Kg
	Accessorio parete per L1/2 GU10 - L1/2 LED bar - L1/2 LED strip / wall accessory for L1/2 GU10 - L1/2 LED bar - L1/2 LED strip					
	NEW! F33 Z05 63 Painted gray	117,00 €				0,020 m ³ 2,50 Kg
	Accessorio parete per L1/2 GU10 - L1/2 LED bar - L1/2 LED strip / wall accessory for L1/2 GU10 - L1/2 LED bar - L1/2 LED strip					
	NEW! F33 M32 63 Painted gray	33,00 €				0,010 m ³ 0,80 Kg
	NEW! F33 M32 74 Golden aluminium	39,00 €				0,010 m ³ 0,80 Kg
	NEW! F33 M33 63 Painted gray	57,00 €				0,015 m ³ 1,20 Kg
	NEW! F33 M33 74 Golden aluminium	66,00 €				0,015 m ³ 1,20 Kg
	NEW! F33 M34 63 Painted gray	86,00 €				0,020 m ³ 1,80 Kg
	NEW! F33 M34 74 Golden aluminium	99,00 €				0,020 m ³ 1,80 Kg
	NEW! F33 M35 63 Painted gray	112,00 €				0,020 m ³ 2,40 Kg
	NEW! F33 M35 74 Golden aluminium	129,00 €				0,020 m ³ 2,40 Kg

LAMINIS F33

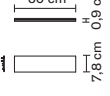
FE Design

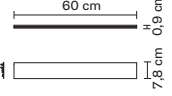
	code	price €	bulb code (not incl.)	bulb price €	electrification	technical info / accessories incl.
  	NEW! F33 M42 63 Painted gray	37,00 €				0,010 m ³ 0,80 Kg IP20 Strip LED non incl. p. 75. Alim. non incl. p. 200-201 / Strip LED not incl. p. 75. Alim. not incl. p. 200-201
  	NEW! F33 M43 63 Painted gray	64,00 €				0,015 m ³ 1,20 Kg IP20 Strip LED non incl. p. 75. Alim. non incl. p. 200-201 / Strip LED not incl. p. 75. Alim. not incl. p. 200-201
  	NEW! F33 M44 63 Painted gray	96,00 €				0,020 m ³ 1,80 Kg IP20 Strip LED non incl. p. 75. Alim. non incl. p. 200-201 / Strip LED not incl. p. 75. Alim. not incl. p. 200-201
  	NEW! F33 M45 63 Painted gray	124,00 €				0,020 m ³ 2,40 Kg IP20 IP20 IP20 IP20 IP20 Strip LED non incl. p. 75. Alim. non incl. p. 200-201 / Strip LED not incl. p. 75. Alim. not incl. p. 200-201
 	NEW! F33 Z10 27 Anodize	24,00 €				0,010 m ³ 0,70 Kg
	NEW! F33 Z10 74 Golden aluminium	28,00 €				0,010 m ³ 0,70 Kg
	NEW! F33 Z11 27 Anodize	44,00 €				0,015 m ³ 0,90 Kg
	NEW! F33 Z11 74 Golden aluminium	51,00 €				0,015 m ³ 0,90 Kg

LAMINIS F33

FE Design

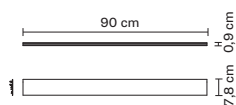

	code	price €	bulb code (not incl.)	bulb price €	electrification	technical info / accessories incl.
NEW!	F33 Z12 27 Anodize	64,00 €				0,020 m ³ 1,30 Kg
NEW!	F33 Z12 74 Golden aluminium	74,00 €				0,020 m ³ 1,30 Kg

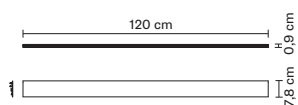

NEW!	F33 Z13 27 Anodize	84,00 €				0,020 m ³ 1,80 Kg
NEW!	F33 Z13 74 Golden aluminium	96,00 €				0,020 m ³ 1,80 Kg

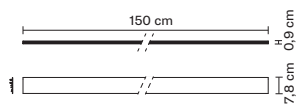

NEW!	F33 Z14 27 Anodize	103,00 €				0,025 m ³ 2,10 Kg
NEW!	F33 Z14 74 Golden aluminium	119,00 €				0,025 m ³ 2,10 Kg

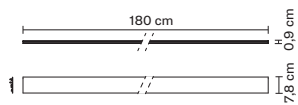

NEW!	F33 Z15 27 Anodize	121,00 €				0,025 m ³ 2,50 Kg
NEW!	F33 Z15 74 Golden aluminium	140,00 €				0,025 m ³ 2,50 Kg

LAMINIS F33

FE Design

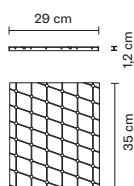
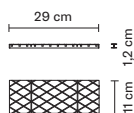
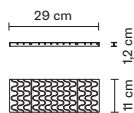
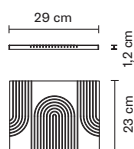

	code	price €	bulb code (not incl.)	bulb price €	electrification	technical info / accessories incl.
NEW!	F33 V01 C2 00 Transparent	2x58,00 €				0,009 m ³ 4,50 Kg
			5 ferma vetro per ogni confezione. Altri colori su richiesta (+20%) / 5 glass fastener for each package. Other colours by request (+20%)			
NEW!	F33 V01 C2 47 Amber	2x70,00 €				0,009 m ³ 4,50 Kg
			5 ferma vetro per ogni confezione / 5 glass fastener for each package			
NEW!	F33 V02 C4 00 Transparent	4x32,00 €				0,008 m ³ 4,50 Kg
			9 ferma vetro per ogni confezione. Altri colori su richiesta (+20%) / 9 glass fastener for each package. Other colours by request (+20%)			
NEW!	F33 V02 C4 47 Amber	4x39,00 €				0,008 m ³ 4,50 Kg
			9 ferma vetro per ogni confezione / 9 glass fastener for each package			
NEW!	F33 V03 C4 00 Transparent	4x32,00 €				0,008 m ³ 4,00 Kg
			9 ferma vetro per ogni confezione. Altri colori su richiesta (+20%) / 9 glass fastener for each package. Other colours by request (+20%)			
NEW!	F33 V04 C4 00 Transparent	4x32,00 €				0,008 m ³ 4,00 Kg
			9 ferma vetro per ogni confezione. Altri colori su richiesta (+20%) / 9 glass fastener for each package. Other colours by request (+20%)			
NEW!	F33 V05 C2 00 Transparent	2x81,00 €				0,013 m ³ 7,00 Kg
			5 ferma vetro per ogni confezione. Altri colori su richiesta (+20%) / 5 glass fastener for each package. Other colours by request (+20%)			

LAMINIS F33

FE Design

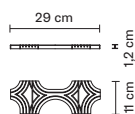

NEW!

F33 V06 C4
00 Transparent

4x32,00 €

bulb code
(not incl.)

bulb price €

electrification

technical info /
accessories incl.

0,008 m³
3,00 Kg

9 ferma vetro per ogni confezione. Altri colori su richiesta (+20%) / 9 glass fastener for each package. Other colours by request (+20%)

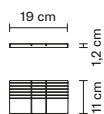

NEW!

F33 V07 C4
00 Transparent

4x35,00 €

0,005 m³
3,10 Kg

9 ferma vetro per ogni confezione. Altri colori su richiesta (+20%) / 9 glass fastener for each package. Other colours by request (+20%)

NEW!

F33 V07 C4
47 Amber

4x43,00 €

0,005 m³
3,10 Kg

9 ferma vetro per ogni confezione. Altri colori su richiesta (+20%) / 9 glass fastener for each package. Other colours by request (+20%)

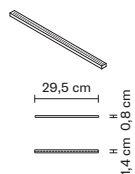

NEW!

A50502

48,00 €



LED 24 Vdc 5W
WHITE 2700K Cri 80

0,005 m³
0,80 Kg

Barra LED / LED bar



NEW!

A50503

39,00 €



LED 24 Vdc 28,8W
WHITE 3000K Cri>80

0,003 m³
0,35 Kg

Strip LED Prezzo al metro. Al momento dell'ordine comunicare all'azienda le misure del progetto. Alim. non incl. pag. 200-201 / LED strip. Price by meter. When ordering, communicate to the company the dimensions of the project



NEW!

A50601

5,45 €

0,002 m³
0,65 Kg

Lente LED. Prezzo al metro. Al momento dell'ordine comunicare all'azienda le misure del progetto. Alim. non incl. pag. 200-201 / LED lens. Price by meter. When ordering, communicate to the company the dimensions of the project

LAMINIS F33

FE Design



	code	price €	bulb code (not incl.)	bulb price €	electrification	technical info / accessories incl.
NEW!	F33 Z20 12 Gold	46,00 €				0,003 m ³ 0,60 Kg
2 tappi per ogni confezione / 2 caps for each package						

NEW!	F33 Z20 15 Chrome	40,00 €				0,003 m ³ 0,60 Kg
2 tappi per ogni confezione / 2 caps for each package						

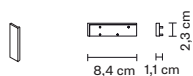

NEW!	F33 Z21 12 Gold	23,00 €				0,001 m ³ 0,03 Kg
Tappo destro / Right cap						

NEW!	F33 Z21 15 Chrome	20,00 €				0,001 m ³ 0,03 Kg
Tappo destro / Right cap						

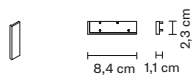

NEW!	F33 Z22 12 Gold	23,00 €				0,001 m ³ 0,03 Kg
Tappo sinistro / Left cap						

NEW!	F33 Z22 15 Chrome	20,00 €				0,001 m ³ 0,03 Kg
Tappo sinistro / Left cap						

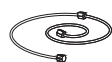

NEW!	A70401	21,00 €				0,001 m ³ 0,02 Kg
Cavo di sostegno. Prezzo al metro / Support cable. Price by meter						

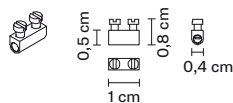

NEW!	A70402	8x0,97 €				0,001 m ³ 0,02 Kg
Ferma cavo di sicurezza / Cable fastener						



NEW!	A70407	9x1,27 €				0,001 m ³ 0,02 Kg
Ferma vetro / Glass fastener						

LAMINIS F33

FE Design

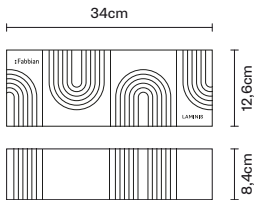

NEW!

code

F33 Z99

price €

132,00 €

bulb code
(not incl.)

Kit Laminis

bulb price €

electrification

technical info /
accessories incl.

0,001 m³
1,86 Kg

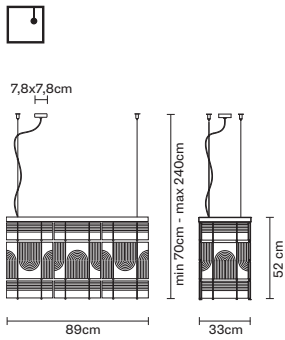

NEW!

F33 A01
00 Transparent

1.862,00 €

A10221C10

10x4,69 €

E27 6x57W
HSGSA

0,205 m³
43,00 Kg
IP20

A10225C01

1x74,20 €

E27 6x9,5W

Struttura cromata e vetri trasparenti / Chrome structure and clear glass

NEW!

F33 A01
47 Amber

2.132,00 €

A10221C10

10x4,69 €

E27 6x57W
HSGSA

0,205 m³
43,00 Kg
IP20

A10225C01

1x74,20 €

E27 6x9,5W

Struttura dorata e vetri color ambra / Golden structure and amber glass

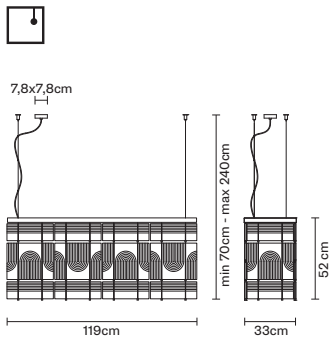

NEW!

F33 A03
00 Transparent

2.299,00 €

A10221C10

10x4,69 €

E27 8x57W
HSGSA

0,300 m³
52,00 Kg
IP20

A10225C01

1x74,20 €

E27 8x9,5W

Struttura cromata e vetri trasparenti / Chrome structure and clear glass

NEW!

F33 A03
47 Amber

2.684,00 €

A10221C10

10x4,69 €

E27 8x57W
HSGSA

0,300 m³
52,00 Kg
IP20

A10225C01

1x74,20 €

E27 8x9,5W

Struttura dorata e vetri color ambra / Golden structure and amber glass

LAMINIS

Sorgente: GU10 / Light source: GU10

Configurazione: 1 o 2 pareti / Layout: 1 or 2 glass walls

1. Scelta barra e angoli / Metal bar and angle option

1a. Barre lineari / Linear bars

Lunghezza minima 30 cm
Modularità ogni 30 cm
Elettrificazione ogni 30 cm
(2x50W GU10).

Su richiesta sono disponibili elettrificazioni diverse.

Ogni sistema deve prevedere l'utilizzo di un modulo da 30 cm di partenza.

I moduli starter sono moduli cablati per l'alimentazione di partenza.

*Minimum length: 30 cm
30 cm modularity
Electrification every 30 cm (2x50W GU10).
Different electrification are available on request.*

Each system has to use a 30 cm starter module.

The starter modules are electrified.

F33M11 63 30 cm (Starter)
F33M12 63 30 cm (Normal)
F33M13 63 60 cm (Normal)
F33M14 63 90 cm (Normal)
F33M15 63 120 cm (Normal)

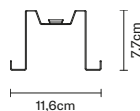
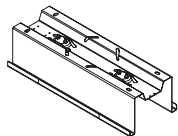

1b. Coppia di tappi / Couple of caps

alluminio dorato
golden aluminium
F33Z20 12

alluminio brillantato
polished aluminium
F33Z20 15

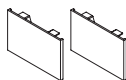

1c. Kit parete / Wall kit

Lunghezza minima 30 cm
Modularità ogni 30 cm
Per la versione a parete vanno aggiunte alle barre lineari indicate qui a lato (F34M1...) uno dei seguenti kit in base alla lunghezza desiderata.

*Minimum length: 30 cm
30 cm modularity
For the wall version, it must be added to the linear bars indicated at right (F34M1...) one of the following kits according to the dsired length.*

F33Z02 63 30 cm
F33Z03 63 60 cm
F33Z04 63 90 cm
F33Z05 63 120 cm

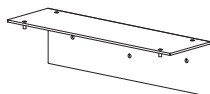

1d. Barra ad angolo / Angle bar

F33M16 63 30x30 cm (Starter)

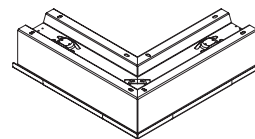

1e. Barra quadrata / Square bar

F33M17 63 30x30 cm (Starter)

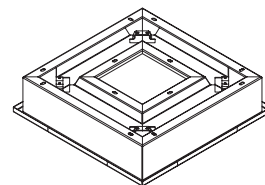

2. Scelta fasce di rivestimento / Cover options

alluminio brillantato
polished aluminium

F33Z10 27 30 cm
F33Z11 27 60 cm
F33Z12 27 90 cm
F33Z13 27 120 cm
F33Z14 27 150 cm
F33Z15 27 180 cm

alluminio dorato
golden aluminium

F33Z10 74 30 cm
F33Z11 74 60 cm
F33Z12 74 90 cm
F33Z13 74 120 cm
F33Z14 74 150 cm
F33Z15 74 180 cm



3. Scelta vetri* / Glass options*



Cerchio / F33V01C2 00
29x23 cm



Cerchio / F33V01C2 47
29x23 cm



Riga / F33V02C4 00
29x11 cm



Riga / F33V02C4 47
29x11 cm



Onda / F33V03C4 00
29x11 cm



Rombo / F33V04C4 00
29x11 cm

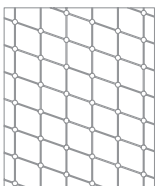

Quadro / F33V05C2 00
29x35 cm



Ponte / F33V06C4 00
29x11 cm



Riga / F33V07C4 00
19x11 cm

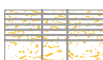

Riga / F33V07C4 47
19x11 cm

4. Cavi di sostegno / Support cable

I cavi di sostegno (A70401) verranno consegnati in base alla disposizione compositiva, della quale devono essere indicate il numero di vetri e il numero degli spazi vuoti interni alla composizione.

The support cables (A70401) delivery is based on the building option preferred, of which the number of glasses and interior empty spaces has to be specified.

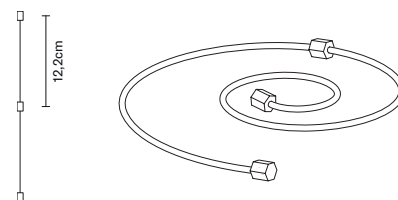

5. Ferma cavi di sicurezza / Security cable fastener

Nel caso in cui si raggiunga un'altezza superiore a 200 cm dovrà essere ordinato necessariamente il ferma cavo di sicurezza (A70402C08), nella misura di 1 per ogni cavo d'acciaio.

In case the composition length were higher than cm 200 one security cable fastener (A70402C08) for each stainless steel cable has to be ordered.

* Su richiesta altre colorazioni (visualizzabili sul sito e/o sul Catalogo Generale) e disegni.

** Other colours (that you can browse on the website or on the General Catalogue) and drawings by request.*



LAMINIS

Sorgente: LED BAR / Light source: LED BAR

Configurazione: 1 o 2 pareti / Layout: 1 or 2 glass walls

1. Scelta barra e angoli / Metal bar and angle option

1a. Barre lineari / Linear bars

Lunghezza minima 30 cm
Modularità ogni 30 cm
Ogni barra è compresa di 4 ferma cavo di sicurezza.
Ogni alimentatore è dimmerabile e supporta max 12 barre LED.

*Minimum length: 30 cm
30 cm modularity.
4 security cable fasteners are included in each bar.
Each driver is dimmable and supports max 12 LED bar.*

F33M01 63 30 cm
(Starter, Alim. non incluso - Alim. not included)

F33M02 63 30 cm
(Starter, 1 Alim. dim. incluso - 1 Alim. dim. included)

F33M03 63 30 cm
(Starter, 2 Alim. dim. incluso - 2 Alim. dim. included)

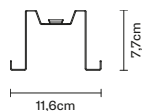
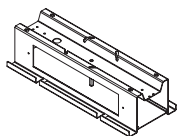

1b. Coppia di tappi / Couple of caps

alluminio dorato
golden aluminium

F33Z20 12

alluminio brillantato
polished aluminium

F33Z20 15

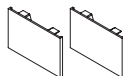

1c. Kit parete / Wall kit

Lunghezza minima 30 cm
Modularità ogni 30 cm
Per la versione a parete vanno aggiunte alle barre lineari indicate a lato (F34M0...) il seguente kit in base alla lunghezza desiderata.

*Minimum length: 30 cm
30 cm modularity.
For the wall version, it must be added to the linear bars indicated at right (F34M0...) the following kit according to the desired length.*

F33Z02 63 30 cm

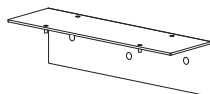

1d. Barra ad angolo / Angle bar

Ogni alimentatore è dimmerabile e supporta max 12 barre LED.
Each driver is dimmable and supports max 12 LED bar.

F33M06 63 30x30 cm
(Starter, 2 Alim. dim. inclusi - 2 Alim. dim. included)

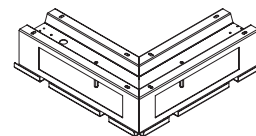

1e. Barra quadrata / Square bar

Ogni alimentatore è dimmerabile e supporta max 12 barre LED.
Each driver is dimmable and supports max 12 LED bar.

F33M07 63 30x30 cm
(Starter, 4 Alim. dim. inclusi - 4 Alim. dim. included)

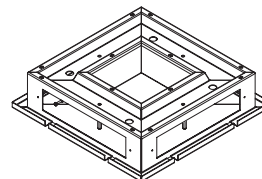

2. Scelta fasce di rivestimento / Cover options

alluminio brillantato
polished aluminium

F33Z10 27 30 cm
F33Z11 27 60 cm
F33Z12 27 90 cm
F33Z13 27 120 cm
F33Z14 27 150 cm
F33Z15 27 180 cm

alluminio dorato
golden aluminium

F33Z10 74 30 cm
F33Z11 74 60 cm
F33Z12 74 90 cm
F33Z13 74 120 cm
F33Z14 74 150 cm
F33Z15 74 180 cm

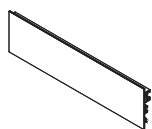

3. Scelta vetri* / Glass options*



Cerchio / F33V01C2 00
29x23 cm

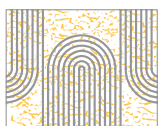

Cerchio / F33V01C2 47
29x23 cm



Riga / F33V02C4 00
29x11 cm



Riga / F33V02C4 47
29x11 cm



Onda / F33V03C4 00
29x11 cm



Rombo / F33V04C4 00
29x11 cm

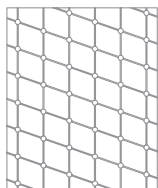

Quadro / F33V05C2 00
29x35 cm



Ponte / F33V06C4 00
29x11 cm



Riga / F33V07C4 00
19x11 cm



Riga / F33V07C4 47
19x11 cm

4. Cavi di sostegno / Support cable

I cavi di sostegno (A70401) verranno consegnati in base alla disposizione compositiva, della quale devono essere indicate il numero di vetri e il numero degli spazi vuoti interni alla composizione.

The support cables (A70401) delivery is based on the building option preferred, of which the number of glasses and interior empty spaces has to be specified.

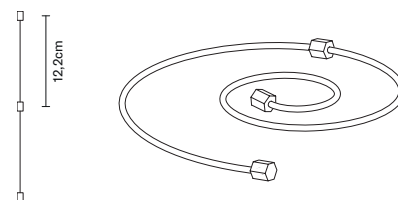

5. Sorgente luminosa a LED / LED light source

A50502C01 5W 24Vdc 2700K 400lm CRI80

Ogni alimentatore è dimmerabile 1..10V e supporta max 12 barre LED. Altri tipi di dimmerazione su richiesta.

Each driver is dimmable 1..10V and supports max 12 LED bar. Other kind of dimming by request.

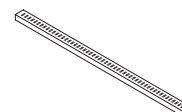

* Su richiesta altre colorazioni (visualizzabili sul sito e/o sul Catalogo Generale) e disegni.

** Other colours (that you can browse on the website or on the General Catalogue) and drawings by request.*

LAMINIS

Sorgente: LED STRIP / *Light source: LED STRIP*

Configurazione: 1 o 2 pareti / *Layout: 1 or 2 glass walls*

1. Scelta barra e angoli / *Metal bar and angle option*

1a. Barre lineari / *Linear bars*

Lunghezza minima 30 cm
Modularità ogni 30 cm
LED e driver non inclusi

*Minimum length: 30 cm
30 cm modularity
LED and driver not included*

F33M22 63 30 cm
F33M23 63 60 cm
F33M24 63 90 cm
F33M25 63 120 cm

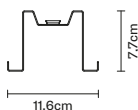
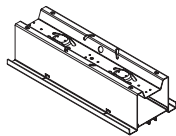

1b. Coppia di tappi / *Couple of caps*

alluminio dorato
golden aluminium

F33Z20 12

alluminio brillantato
polished aluminium

F33Z20 15

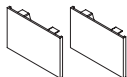

1c. Kit parete / *Wall kit*

Lunghezza minima 30 cm
Modularità ogni 30 cm
Per la versione a parete vanno aggiunte alle barre lineari indicate qui a lato (F34M2...) uno dei seguenti kit in base alla lunghezza desiderata.

*Minimum length: 30 cm
30 cm / 11 3/4" modularity
For the wall version, it must be added to the linear bars indicated at right (F34M2...) one of the following kits according to the dsired length.*

F33Z02 63 30 cm
F33Z03 63 60 cm
F33Z04 63 90 cm
F33Z05 63 120 cm

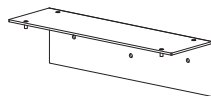

1d. Barra ad angolo / *Angle bar*

F33M26 63 30x30 cm (Starter)

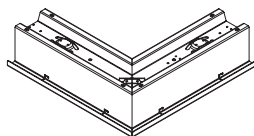

1e. Barra quadrata / *Square bar*

F33M27 63 30x30 cm

LED e driver non inclusi
LED and driver not included

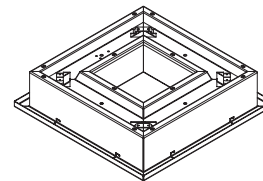

2. Scelta fasce di rivestimento / *Cover options*

alluminio brillantato
polished aluminium

F33Z10 27 30 cm
F33Z11 27 60 cm
F33Z12 27 90 cm
F33Z13 27 120 cm
F33Z14 27 150 cm
F33Z15 27 180 cm

alluminio dorato
golden aluminium

F33Z10 74 30 cm
F33Z11 74 60 cm
F33Z12 74 90 cm
F33Z13 74 120 cm
F33Z14 74 150 cm
F33Z15 74 180 cm

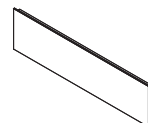

3. Scelta vetri* / Glass options*



Cerchio / F33V01C2 00
29x23 cm



Cerchio / F33V01C2 47
29x23 cm



Riga / F33V02C4 00
29x11 cm



Riga / F33V02C4 47
29x11 cm



Onda / F33V03C4 00
29x11 cm



Rombo / F33V04C4 00
29x11 cm

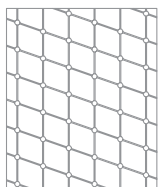

Quadro / F33V05C2 00
29x35 cm



Ponte / F33V06C4 00
29x11 cm



Riga / F33V07C4 00
19x11 cm



Riga / F33V07C4 47
19x11 cm

* Su richiesta altre colorazioni (visualizzabili sul sito e/o sul Catalogo Generale) e disegni.

* Other colours (that you can browse on the website or on the General Catalogue) and drawings by request.

4. Cavi di sostegno / Support cable

I cavi di sostegno (A70401) verranno consegnati in base alla disposizione compositiva, della quale devono essere indicate il numero di vetri e il numero degli spazi vuoti interni alla composizione.

The support cables (A70401) delivery is based on the building option preferred, of which the number of glasses and interior empty spaces has to be specified.

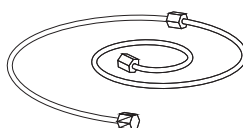
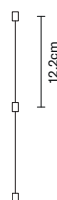

5. Ferma cavi di sicurezza / Security cable fastener

Nel caso in cui si raggiunga un'altezza superiore a 200 cm dovrà essere ordinato necessariamente il ferma cavo di sicurezza (A70402C08), nella misura di 1 per ogni cavo d'acciaio.

In case the composition length were higher than cm 200 one security cable fastener (A70402C08) for each stainless steel cable has to be ordered.



6. Sorgente luminosa a LED e lente / LED and lens light source

A50503 LED Strip 24Vdc 3000K Cri 80
28,8W 2600 lm al metro / by meter

A50601 LED Lens 30°

Vendute al metro.
Specificare le lunghezze delle singole tratte lineari.

*Sold by meter.
Specify the lengths of the single linear section.*

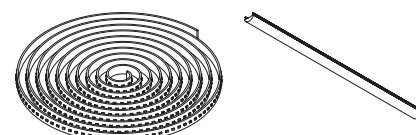

LAMINIS

Senza Sorgente / No Light source

Configurazione: 1 parete / Layout: 1 glass wall

1. Scelta barra e angoli / Metal bar and angle option

1a. Barre lineari / Linear bars

Lunghezza minima 30 cm
Modularità ogni 30 cm

*Minimum length: 30 cm
30 cm modularity*

alluminio brillantato
polished aluminium

F33M32 63 30 cm
F33M33 63 60 cm
F33M34 63 90 cm
F33M35 63 120 cm

alluminio dorato
golden aluminium

F33M32 74 30 cm
F33M33 74 60 cm
F33M34 74 90 cm
F33M35 74 120 cm

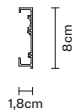
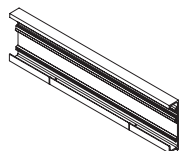

1b. Tappi / Caps

alluminio brillantato
polished aluminium

F33Z21 15 Tappo destro / Right Cap
F33Z22 15 Tappo sinistro / Left Cap

alluminio dorato
golden aluminium

F33Z21 12 Tappo destro / Right Cap
F33Z22 12 Tappo sinistro / Left Cap



2. Scelta fasce di rivestimento / Cover options

alluminio brillantato
polished aluminium

F33Z10 27 30 cm
F33Z11 27 60 cm
F33Z12 27 90 cm
F33Z13 27 120 cm
F33Z14 27 150 cm
F33Z15 27 180 cm

alluminio dorato
golden aluminium

F33Z10 74 30 cm
F33Z11 74 60 cm
F33Z12 74 90 cm
F33Z13 74 120 cm
F33Z14 74 150 cm
F33Z15 74 180 cm

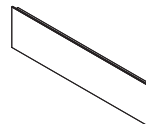

3. Scelta vetri* / Glass options*



Cerchio / F33V01C2 00
29x23 cm



Cerchio / F33V01C2 47
29x23 cm



Riga / F33V02C4 00
29x11 cm



Riga / F33V02C4 47
29x11 cm



Onda / F33V03C4 00
29x11 cm



Rombo / F33V04C4 00
29x11 cm

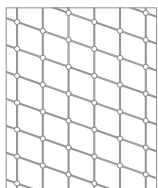

Quadro / F33V05C2 00
29x35 cm



Ponte / F33V06C4 00
29x11 cm



Riga / F33V07C4 00
19x11 cm

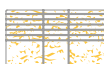

Riga / F33V07C4 47
19x11 cm

4. Cavi di sostegno / Support cable

I cavi di sostegno (A70401) verranno consegnati in base alla disposizione compositiva, della quale devono essere indicate il numero di vetri e il numero degli spazi vuoti interni alla composizione.

The support cables (A70401) delivery is based on the building option preferred, of which the number of glasses and interior empty spaces has to be specified.

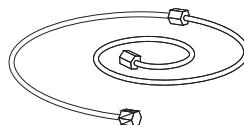
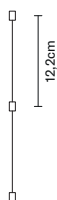

5. Ferma cavi di sicurezza / Security cable fastener

Nel caso in cui si raggiunga un'altezza superiore a 200 cm dovrà essere ordinato necessariamente il ferma cavo di sicurezza (A70402C08), nella misura di 1 per ogni cavo d'acciaio.

In case the composition length were higher than cm 200 one security cable fastener (A70402C08) for each stainless steel cable has to be ordered.

* Su richiesta altre colorazioni (visualizzabili sul sito e/o sul Catalogo Generale) e disegni.

** Other colours (that you can browse on the website or on the General Catalogue) and drawings by request.*



LAMINIS

Sorgente: LED STRIP / Light source: LED STRIP

Configurazione: 1 parete / Layout: 1 glass wall

1. Scelta barra e angoli / Metal bar and angle option

1a. Barre lineari / Linear bars

Lunghezza minima 30 cm
Modularità ogni 30 cm
LED e driver non inclusi

*Minimum length: 30 cm
30 cm modularity
LED and driver not included*

F33M42 63 30 cm
F33M43 63 60 cm
F33M44 63 90 cm
F33M45 63 120 cm

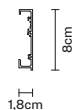
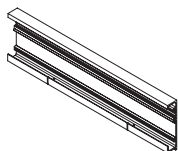

1b. Tappi / Caps

alluminio brillantato
polished aluminium

F33Z21 15 Tappo destro / Right Cap
F33Z22 15 Tappo sinistro / Left Cap

alluminio dorato
golden aluminium

F33Z21 12 Tappo destro / Right Cap
F33Z22 12 Tappo sinistro / Left Cap



2. Scelta fasce di rivestimento / Cover options

alluminio brillantato
polished aluminium

F33Z10 27 30 cm
F33Z11 27 60 cm
F33Z12 27 90 cm
F33Z13 27 120 cm
F33Z14 27 150 cm
F33Z15 27 180 cm

alluminio dorato
golden aluminium

F33Z10 74 30 cm
F33Z11 74 60 cm
F33Z12 74 90 cm
F33Z13 74 120 cm
F33Z14 74 150 cm
F33Z15 74 180 cm

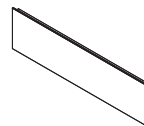

3. Scelta vetri* / Glass options*

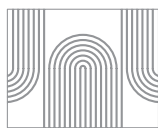

Cerchio / F33V01C2 00
29x23 cm

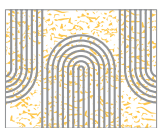

Cerchio / F33V01C2 47
29x23 cm



Riga / F33V02C4 00
29x11 cm



Riga / F33V02C4 47
29x11 cm



Onda / F33V03C4 00
29x11 cm



Rombo / F33V04C4 00
29x11 cm

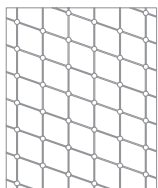

Quadro / F33V05C2 00
29x35 cm



Ponte / F33V06C4 00
29x11 cm



Riga / F33V07C4 00
19x11 cm

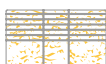

Riga / F33V07C4 47
19x11 cm

4. Cavi di sostegno / Support cable

I cavi di sostegno (A70401) verranno consegnati in base alla disposizione compositiva, della quale devono essere indicate il numero di vetri e il numero degli spazi vuoti interni alla composizione.

The support cables (A70401) delivery is based on the building option preferred, of which the number of glasses and interior empty spaces has to be specified.

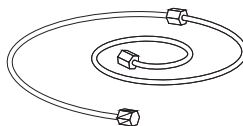
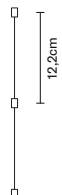

5. Ferma cavi di sicurezza / Security cable fastener

Nel caso in cui si raggiunga un'altezza superiore a 200 cm dovrà essere ordinato necessariamente il ferma cavo di sicurezza (A70402C08), nella misura di 1 per ogni cavo d'acciaio.

In case the composition length were higher than cm 200 one security cable fastener (A70402C08) for each stainless steel cable has to be ordered.



6. Sorgente luminosa a LED e lente / LED and lens light source

A50503 LED Strip 24Vdc 3000K Cri 80
28,8W 2600 lm al metro / *by meter*
A50601 LED Lens 30°

Vendute al metro.
Specificare le lunghezze delle singole tratte lineari.

Sold by meter.
Specify the lengths of the single linear section.

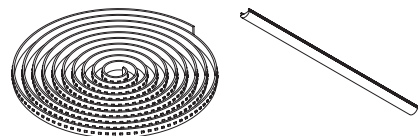

* Su richiesta altre colorazioni (visualizzabili sul sito e/o sul Catalogo Generale) e disegni.

** Other colours (that you can browse on the website or on the General Catalogue) and drawings by request.*

LAMINIS

My Glass

CUSTOM BASE

1. Il percorso di personalizzazione inizia con la scelta dei vetri Laminis che andranno a formare la parete.

The customization path starts with the choice of Laminis glasses which will form the glass wall.

2. Combinandoli si possono ottenere infinite possibilità di personalizzazione.

Combining them you can get endless customization possibilities.

EXAMPLE



Cerchio / F33V01C2 00
29x23 cm / 11 3/8" x 9"



Cerchio / F33V01C2 47
29x23 cm / 11 3/8" x 9"



Riga / F33V02C4 00
29x11 cm / 11 3/8" x 4 5/16"



Riga / F33V02C4 47
29x11 cm / 11 3/8" x 4 5/16"



Onda / F33V03C4 00
29x11 cm / 11 3/8" x 4 5/16"



Rombo / F33V04C4 00
29x11 cm / 11 3/8" x 4 5/16"

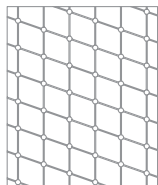

Quadro / F33V05C2 00
29x35 cm / 11 3/8" x 13 3/4"



Ponte / F33V06C4 00
29x11 cm / 11 3/8" x 4 5/16"



Riga / F33V07C4 00
19x11 cm



Riga / F33V07C4 47
19x11 cm

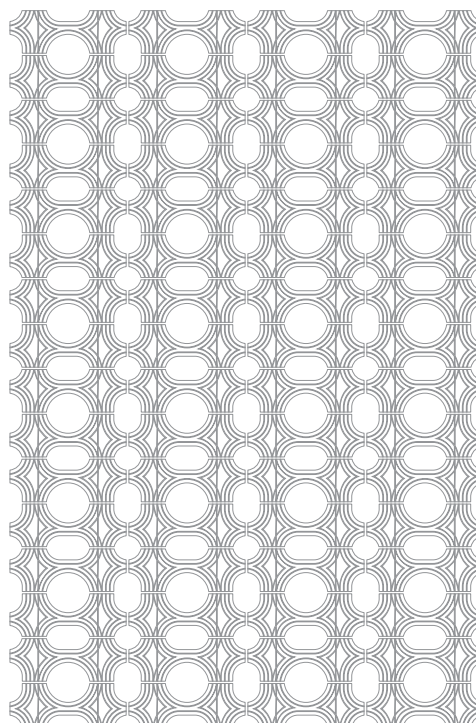

F33V06C4 00

Fantasia regolare
Regular pattern

Ogni Laminis sarà unica
Each Laminis will be unique

EXAMPLE

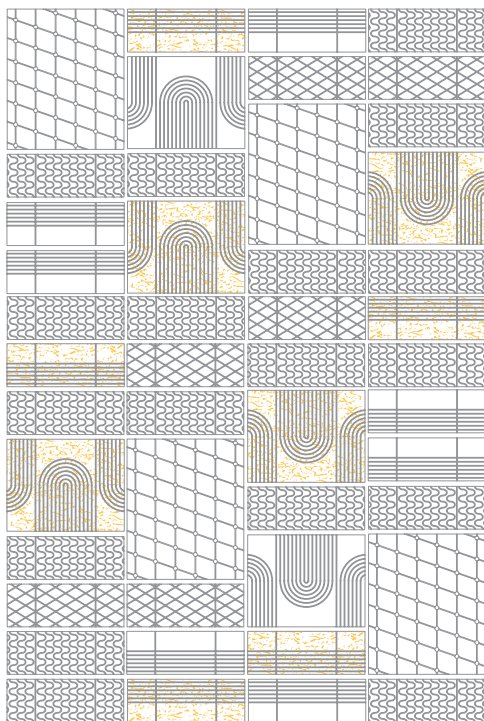

F33V01C2 00 / F33V01C2 47 / F33V02C4 00 / F33V02C4 47 /
F33V03C4 00 / F33V04C4 00 / F33V05C2 00

Mescolanza di diversi vetri
Mix of different glasses

EXAMPLE

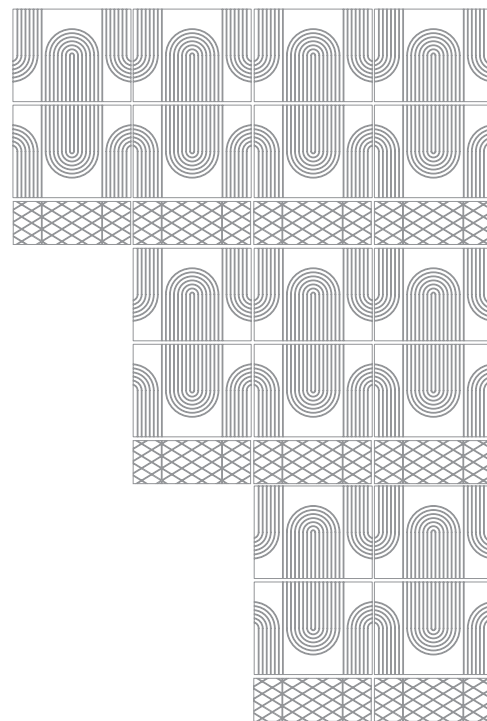

F33V01C2 00 / F33V04C4 00

Distribuzione personalizzata dei vetri
Custom combination of the glasses

LAMINIS

My Glass

TOTAL CUSTOM

Infinite possibilità

DIMENSIONE VETRI GLASSES DIMENSION

La larghezza di tutti i vetri parte da una base di 30 cm/11 3/4" e si sviluppa in multipli.

The various glasses must have a width of 30 cm/11 3/4", or multiple, although they have different sizes.

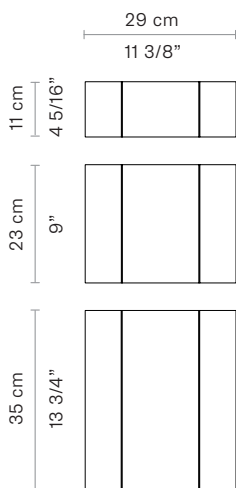

DISEGNO PERSONALIZZATO DESIGN IT YOUR SELF

C'è la possibilità di scegliere tra le lavorazioni grafiche del vetro da noi proposte oppure possiamo produrre il motivo grafico disegnato da te.

You can choose one of our glass patterns or you can create your own design and we'll produce it for you.

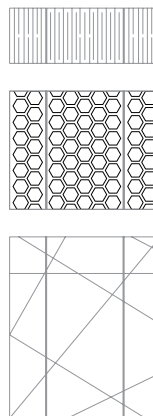

* Fattibilità dei disegni da verificare in base al processo produttivo vetrario.

Feasibility of the designs to be verified according to the glass production process.

Endless Possibilities

COLORAZIONE COLOUR

C'è la possibilità di personalizzare la finitura cromatica dei singoli vetri scegliendo tra quelli qui indicati.

Possibility to choose the colour finishing of the single glasses among those described here.

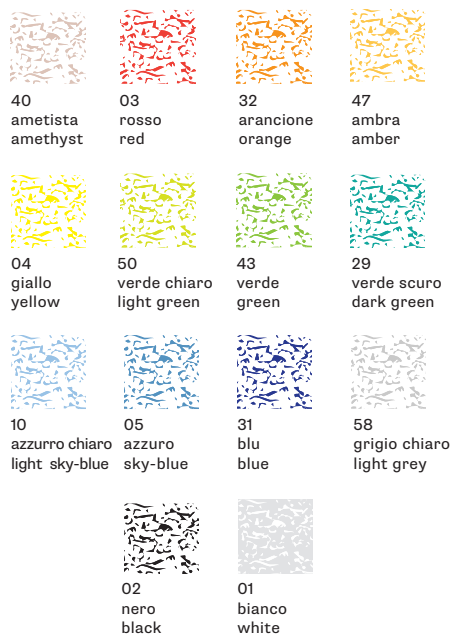

* Gli stessi colori (visualizzabili sul sito e/o sul Catalogo Generale), fatti a mano, potrebbero subire delle variazioni.

** The same colours (that you can browse on the website or on the General Catalogue), handmade, could change.*

DISTRIBUZIONE ARRANGEMENT

C'è la possibilità di scegliere la distribuzione dei singoli vetri.

Possibility to choose the arrangement of the single glasses.

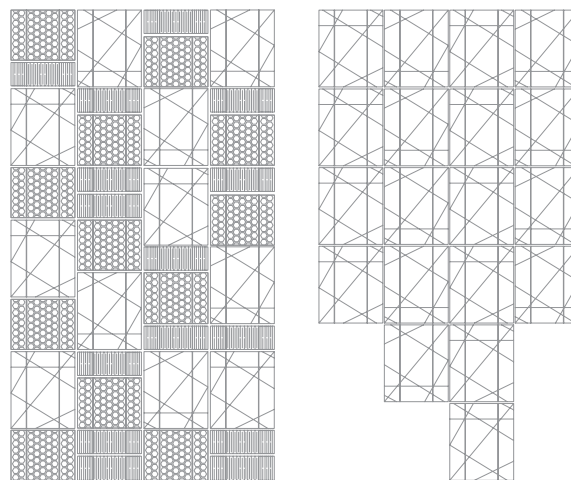

LOOP F35

Constance Guisset

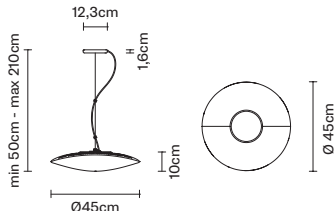

NEW!

F35 A01
00 Transparent

price €
649,00 €

bulb code
(not incl.)



bulb price €

electrification

LED 1x24W
WHITE 3000K Cri 80

technical info / accessories incl.
0,061 m³
4,50 Kg
IP20

NEW!

F35 A02
00 Transparent

price €
649,00 €

bulb code
(not incl.)



bulb price €

LED 1x24W
WHITE 2700K Cri 80

0,061 m³
4,50 Kg
IP20

NEW!

F35 A03
00 Transparent

price €
539,00 €

bulb code
(not incl.)



12x16,41 €

E27 1x150W
HSGST

0,061 m³
4,50 Kg
IP20

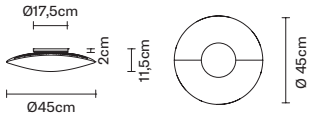

NEW!

F35 G01
00 Transparent

price €
517,00 €

bulb code
(not incl.)



bulb price €

LED 1x17,5W
WHITE 3000K Cri 80

0,061 m³
4,20 Kg
IP40

NEW!

F35 G02
00 Transparent

price €
517,00 €

bulb code
(not incl.)



bulb price €

LED 1x17,5W
WHITE 2700K Cri 80

0,061 m³
4,20 Kg
IP40

NEW!

F35 G03
00 Transparent

price €
407,00 €

bulb code
(not incl.)



12x16,41 €

E27 1x150W
HSGST

0,061 m³
4,20 Kg
IP40

LUMI F07

D&G Studio

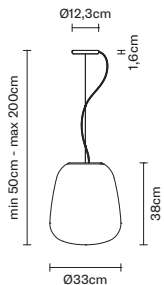

NEW!

F07 A15
01 White

price €
298,00 €

bulb code
(not incl.)



12x16,41 €

E27 1x150W
HSGST

0,108 m³
5,50 Kg
IP20

bulb code
(not incl.)



10x23,63 €

E27 1x30W
FBT

NEW!

F07 A36
01 White

price €
410,00 €

bulb code
(not incl.)



bulb price €

LED 1x24W
WHITE 2700K Cri 80

0,108 m³
5,50 Kg
IP20

LED 1x24W
WHITE 3000K Cri 80

0,108 m³
5,50 Kg
IP20

LUMI F07

D&G Studio

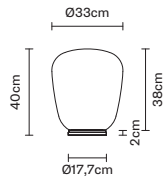

code

price €

bulb code
(not incl.)

bulb price €

electrification

technical info /
accessories incl.

F07 B21
01 White

246,00 €

A10208C12

12x16,41 €

E27 1x150W
HSGST

0,069 m³
4,95 Kg
IP40

A10218C10

10x23,63 €

E27 1x30W
FBT

F07 B41
01 White

304,00 €



LED 1x17,5W
WHITE 3000K Cri 80

0,069 m³
4,95 Kg
IP40

NEW!

F07 B42
01 White

304,00 €



LED 1x17,5W
WHITE 2700K Cri 80

0,069 m³
4,95 Kg
IP40

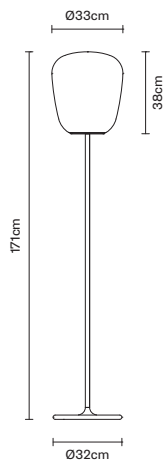

F07 C07
01 White

582,00 €

A10208C12

12x16,41 €

E27 1x150W
HSGST

0,450 m³
15,00 Kg
IP40

A10218C10

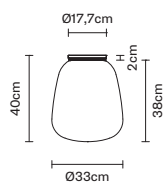

10x23,63 €

E27 1x30W
FBT



F07 E07
01 White

239,00 €

A10208C12

12x16,41 €

E27 1x150W
HSGST

0,069 m³
4,95 Kg
IP40

A10218C10

10x23,63 €

E27 1x30W
FBT

F07 E11
01 White

296,00 €



LED 1x17,5W
WHITE 3000K Cri 80

0,069 m³
4,95 Kg
IP40

NEW!

F07 E12
01 White

296,00 €



LED 1x17,5W
WHITE 2700K Cri 80

0,069 m³
4,95 Kg
IP40

LUMI F07

D&G Studio

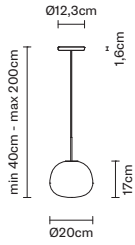

code

price €

bulb code
(not incl.)

bulb price €

electrification

technical info /
accessories incl.

F07 A05
01 White

161,00 €

A11004C20

20x3,91 €

G9 1x60W
HSGS

0,030 m³
3,00 Kg
IP40

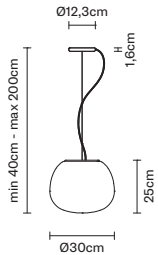

F07 A07
01 White

253,00 €

A10208C12

12x16,41 €

E27 1x150W
HSGST

0,120 m³
5,00 Kg
IP20

A10218C10

10x23,63 €

E27 1x30W
FBT

F07 A41
01 White

365,00 €



LED 1x24W
WHITE 3000K Cri 80

0,120 m³
5,00 Kg
IP20

NEW!

F07 A42
01 White

365,00 €



LED 1x24W
WHITE 2700K Cri 80

0,120 m³
5,00 Kg
IP20

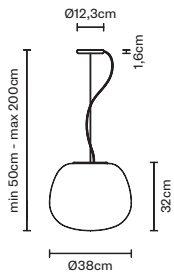

F07 A01
01 White

304,00 €

A10208C12

12x16,41 €

E27 1x150W
HSGST

0,130 m³
5,50 Kg
IP20

A10218C10

10x23,63 €

E27 1x30W
FBT

F07 A37
01 White

416,00 €



LED 1x24W
WHITE 3000K Cri 80

0,130 m³
5,50 Kg
IP20

NEW!

F07 A38
01 White

416,00 €



LED 1x24W
WHITE 2700K Cri 80

0,130 m³
5,50 Kg
IP20

LUMI F07

D&G Studio

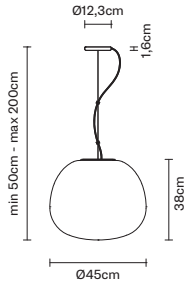

code

price €

bulb code
(not incl.)

bulb price €

electrification

technical info /
accessories incl.

F07 A03
01 White

344,00 €

A10209C12

12x16,80 €

E27 1x205W
HSGST

0,150 m³
7,50 Kg
IP20

A10218C10

10x23,63 €

E27 1x30W
FBT

F07 A39
01 White

458,00 €



LED 1x24W
WHITE 3000K Cri 80

0,150 m³
7,50 Kg
IP20

NEW!

F07 A40
01 White

458,00 €



LED 1x24W
WHITE 2700K Cri 80

0,150 m³
7,50 Kg
IP20

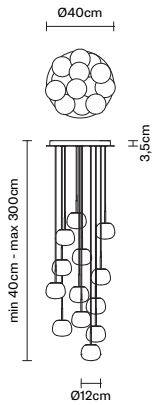

F07 A29
01 White

2.046,00 €

A11001C20

20x3,91 €

G9 13x20W
HSGS

0,490 m³
15,00 Kg
IP40

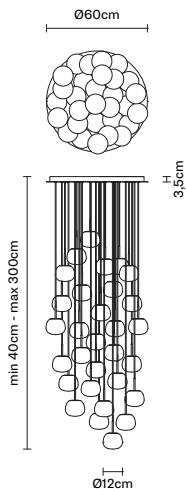

F07 A31
01 White

4.378,00 €

A11001C20

20x3,91 €

G9 30x20W
HSGS

0,990 m³
32,00 Kg
IP40

LUMI F07

D&G Studio

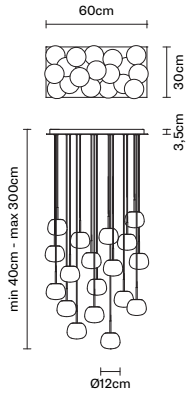

code

price €

bulb code
(not incl.)

bulb price €

electrification

technical info /
accessories incl.

F07 A33
01 White

2.761,00 €

A11001C20

20x3,91 €

G9 18x20W
HSGS

0,630 m³
20,00 Kg
IP40

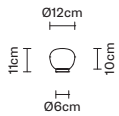

F07 B01
01 White

106,00 €

A11001C20

20x3,91 €

G9 1x20W
HSGS

0,030 m³
1,00 Kg
IP40

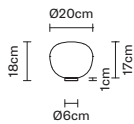

F07 B07
01 White

120,00 €

A11003C20

20x3,91 €

G9 1x48W
HSGS

0,030 m³
3,00 Kg
IP40

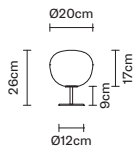

F07 B03
01 White

160,00 €

A11003C20

20x3,91 €

G9 1x48W
HSGS

0,030 m³
3,00 Kg
IP40

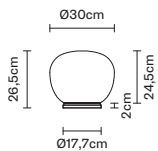

F07 B09
01 White

202,00 €

A10208C12

12x16,41 €

E27 1x150W
HSGST

0,120 m³
5,00 Kg
IP40

A10218C10

10x23,63 €

E27 1x30W
FBT

F07 B45
01 White

259,00 €



LED 1x17,5W
WHITE 3000K Cri 80

0,120 m³
5,00 Kg
IP40



F07 B46
01 White

259,00 €



LED 1x17,5W
WHITE 2700K Cri 80

0,120 m³
5,00 Kg
IP40

LUMI F07

D&G Studio

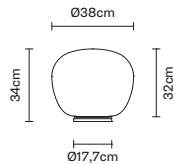

code

price €

bulb code
(not incl.)

bulb price €

electrification

technical info /
accessories incl.

F07 B05
01 White

252,00 €

A10208C12

12x16,41 €

E27 1x150W
HSGST

0,120 m³
6,50 Kg
IP40

A10218C10

10x23,63 €

E27 1x30W
FBT

F07 B43
01 White

309,00 €



LED 1x17,5W
WHITE 3000K Cri 80

0,120 m³
6,50 Kg
IP40

NEW!

F07 B44
01 White

309,00 €



LED 1x17,5W
WHITE 2700K Cri 80

0,120 m³
6,50 Kg
IP40

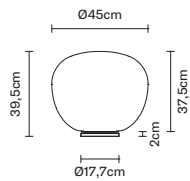

F07 B11
01 White

293,00 €

A10208C12

12x16,41 €

E27 1x150W
HSGST

0,150 m³
7,50 Kg
IP40

A10218C10

10x23,63 €

E27 1x30W
FBT

F07 B47
01 White

350,00 €



LED 1x17,5W
WHITE 3000K Cri 80

0,150 m³
7,50 Kg
IP40

NEW!

F07 B48
01 White

350,00 €



LED 1x17,5W
WHITE 2700K Cri 80

0,150 m³
7,50 Kg
IP40

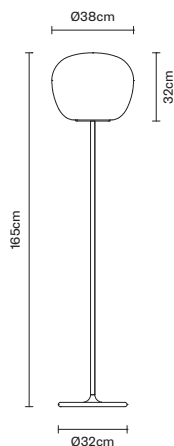

F07 C01
01 White

588,00 €

A10208C12

12x16,41 €

E27 1x150W
HSGST

0,450 m³
15,00 Kg
IP40

A10218C10

10x23,63 €

E27 1x30W
FBT

LUMI F07

D&G Studio

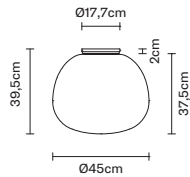

code

price €

bulb code
(not incl.)

bulb price €

electrification

technical info /
accessories incl.

F07 E05
01 White

286,00 €

A10209C12

12x16,80 €

E27 1x205W
HSGST

0,150 m³
7,50 Kg
IP40

A10218C10

10x23,63 €

E27 1x30W
FBT

F07 E13
01 White

343,00 €



LED 1x17,5W
WHITE 3000K Cri 80

0,150 m³
7,50 Kg
IP40



F07 E14
01 White

343,00 €



LED 1x17,5W
WHITE 2700K Cri 80

0,150 m³
7,50 Kg
IP40

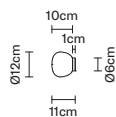

F07 G01
01 White

101,00 €

A11001C20

20x3,91 €

G9 1x20W
HSGS

0,030 m³
1,00 Kg
IP44

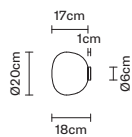

F07 G03
01 White

114,00 €

A11004C20

20x3,91 €

G9 1x60W
HSGS

0,030 m³
3,00 Kg
IP44

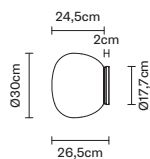

F07 G05
01 White

194,00 €

A10208C12

12x16,41 €

E27 1x150W
HSGST

0,120 m³
5,00 Kg
IP40

A10218C10

10x23,63 €

E27 1x30W
FBT

F07 G35
01 White

251,00 €



LED 1x17,5W
WHITE 3000K Cri 80

0,120 m³
5,00 Kg
IP40



F07 G36
01 White

251,00 €



LED 1x17,5W
WHITE 2700K Cri 80

0,120 m³
5,00 Kg
IP40

LUMI F07

D&G Studio

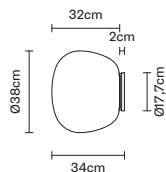

code

price €

bulb code
(not incl.)

bulb price €

electrification

technical info /
accessories incl.

F07 G07
01 White

245,00 €

A10208C12

12x16,41 €

E27 1x150W
HSGST

0,120 m³
6,50 Kg
IP40

A10218C10

10x23,63 €

E27 1x30W
FBT

F07 G37
01 White

301,00 €



LED 1x17,5W
WHITE 3000K Cri 80

0,120 m³
6,50 Kg
IP40

NEW!

F07 G38
01 White

301,00 €



LED 1x17,5W
WHITE 2700K Cri 80

0,120 m³
6,50 Kg
IP40

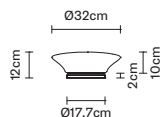

F07 B13
01 White

186,00 €

A10207C12

12x16,41 €

E27 1x100W
HSGST

0,035 m³
2,40 Kg
IP40

A10212C10

10x13,98 €

E27 1x15W
FBG

F07 B49
01 White

243,00 €



LED 1x17,5W
WHITE 3000K Cri 80

0,035 m³
2,40 Kg
IP40

NEW!

F07 B50
01 White

243,00 €



LED 1x17,5W
WHITE 2700K Cri 80

0,035 m³
2,40 Kg
IP40

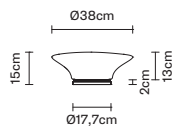

F07 B15
01 White

235,00 €

A10207C12

12x16,41 €

E27 1x100W
HSGST

0,052 m³
3,40 Kg
IP40

A10213C10

10x17,19 €

E27 1x20W
FBG

F07 B51
01 White

293,00 €



LED 1x17,5W
WHITE 3000K Cri 80

0,052 m³
3,40 Kg
IP40

NEW!

F07 B52
01 White

293,00 €



LED 1x17,5W
WHITE 2700K Cri 80

0,052 m³
3,40 Kg
IP40

LUMI F07

D&G Studio

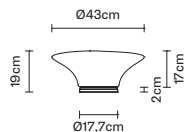

code

price €

bulb code
(not incl.)

bulb price €

electrification

technical info /
accessories incl.

F07 B17
01 White

337,00 €

A10207C12

12x16,41 €

E27 1x100W
HSGST

0,069 m³
4,95 Kg
IP40

A10213C10

10x17,19 €

E27 1x20W
FBG

F07 B53
01 White

395,00 €



LED 1x17,5W
WHITE 3000K Cri 80

0,069 m³
4,95 Kg
IP40

NEW!

F07 B54
01 White

395,00 €



LED 1x17,5W
WHITE 2700K Cri 80

0,069 m³
4,95 Kg
IP40

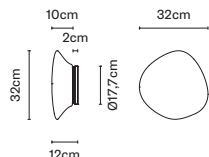

F07 G15
01 White

179,00 €

A10207C12

12x16,41 €

E27 1x100W
HSGST

0,035 m³
2,40 Kg
IP40

A10212C10

10x13,98 €

E27 1x15W
FBG

Base per composizioni F07Z0101 p. 101 / Base for compositions F07Z0101 p. 101

F07 G39
01 White

235,00 €



LED 1x17,5W
WHITE 3000K Cri 80

0,035 m³
2,40 Kg
IP40

Base per composizioni F07Z0101 p. 101 / Base for compositions F07Z0101 p. 101

NEW!

F07 G40
01 White

235,00 €



LED 1x17,5W
WHITE 2700K Cri 80

0,035 m³
2,40 Kg
IP40

Base per composizioni F07Z0101 p. 101 / Base for compositions F07Z0101 p. 101

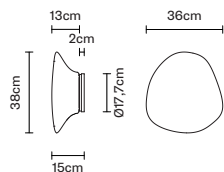

F07 G17
01 White

228,00 €

A10207C12

12x16,41 €

E27 1x100W
HSGST

0,052 m³
3,40 Kg
IP40

A10213C10

10x17,19 €

E27 1x20W
FBG

Base per composizioni F07Z0101 p. 101 / Base for compositions F07Z0101 p. 101

F07 G41
01 White

285,00 €



LED 1x17,5W
WHITE 3000K Cri 80

0,052 m³
3,40 Kg
IP40

Base per composizioni F07Z0101 p. 101 / Base for compositions F07Z0101 p. 101

NEW!

F07 G42
01 White

285,00 €



LED 1x17,5W
WHITE 2700K Cri 80

0,052 m³
3,40 Kg
IP40

Base per composizioni F07Z0101 p. 101 / Base for compositions F07Z0101 p. 101

LUMI F07

D&G Studio

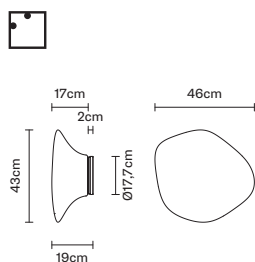

code

price €

bulb code
(not incl.)

bulb price €

electrification

technical info /
accessories incl.

F07 G19
01 White

330,00 €

A10208C12

12x16,41 €

E27 1x150W
HSGST

0,069 m³
4,95 Kg
IP40

A10213C10

10x17,19 €

E27 1x20W
FBG

Base per composizioni F07Z0101 p. 101 / Base for compositions F07Z0101 p. 101

F07 G43
01 White

388,00 €



LED 1x17,5W
WHITE 3000K Cri 80

0,069 m³
4,95 Kg
IP40

Base per composizioni F07Z0101 p. 101 / Base for compositions F07Z0101 p. 101



F07 G44
01 White

388,00 €



LED 1x17,5W
WHITE 2700K Cri 80

0,069 m³
4,95 Kg
IP40

Base per composizioni F07Z0101 p. 101 / Base for compositions F07Z0101 p. 101

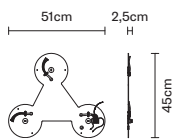

F07 Z01
01 White

107,00 €

0,069 m³
3,65 Kg

Pannello sagomato per composizioni a parete e soffitto
Shaped panel for wall and ceiling compositions

1xF07Z0101 1xF07Z0101 1xF07Z0101 1xF07Z0101
1xF07G1501 1xF07G1501 2xF07G1501 3xF07G1501
1xF07G1701 2xF07G1701 1xF07G1701
1xF07G1901

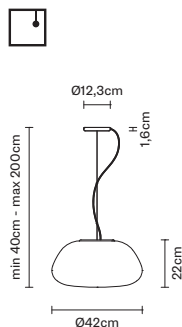

F07 A13
01 White

314,00 €

A10208C12

12x16,41 €

E27 1x150W
HSGST

0,108 m³
5,50 Kg
IP20

A10212C10

10x13,98 €

E27 1x15W
FBG

F07 A43
01 White

427,00 €



LED 1x24W
WHITE 3000K Cri 80

0,108 m³
5,50 Kg
IP20



F07 A44
01 White

427,00 €



LED 1x24W
WHITE 2700K Cri 80

0,108 m³
5,50 Kg
IP20

LUMI F07

D&G Studio

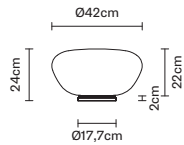

code

price €

**bulb code
(not incl.)**

bulb price €

electrification

**technical info /
accessories incl.**

F07 B19
01 White

263,00 €

A10208C12

12x16,41 €

E27 1x150W
HSGST

0,069 m³
4,95 Kg
IP40

A10212C10

10x13,98 €

E27 1x15W
FBG

F07 B55
01 White

320,00 €



LED 1x17,5W
WHITE 3000K Cri 80

0,069 m³
4,95 Kg
IP40



F07 B56
01 White

320,00 €



LED 1x17,5W
WHITE 2700K Cri 80

0,069 m³
4,95 Kg
IP40

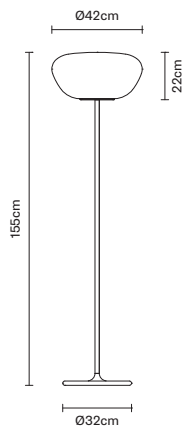

F07 C05
01 White

599,00 €

A10208C12

12x16,41 €

E27 1x150W
HSGST

0,450 m³
15,00 Kg
IP40

A10212C10

10x13,98 €

E27 1x15W
FBG

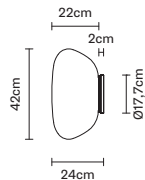

F07 G21
01 White

256,00 €

A10208C12

12x16,41 €

E27 1x150W
HSGST

0,069 m³
4,95 Kg
IP40

A10212C10

10x13,98 €

E27 1x15W
FBG

F07 G45
01 White

312,00 €



LED 1x17,5W
WHITE 3000K Cri 80

0,069 m³
4,95 Kg
IP40



F07 G46
01 White

312,00 €



LED 1x17,5W
WHITE 2700K Cri 80

0,069 m³
4,95 Kg
IP40

LUMI F07

D&G Studio

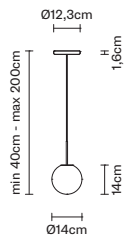

code

price €

**bulb code
(not incl.)**

bulb price €

electrification

**technical info /
accessories incl.**

F07 A17
01 White

148,00 €

A11002C20

20x3,91 €

G9 1x33W
HSGS

0,030 m³
1,00 Kg
IP40

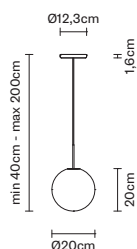

F07 A19
01 White

157,00 €

A11004C20

20x3,91 €

G9 1x60W
HSGS

0,030 m³
3,00 Kg
IP40

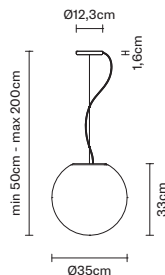

F07 A21
01 White

271,00 €

A10208C12

12x16,41 €

E27 1x150W
HSGST

0,120 m³
5,00 Kg
IP20

A10218C10

10x23,63 €

E27 1x30W
FBT

F07 A45
01 White

384,00 €



LED 1x24W
WHITE 3000K Cri 80

0,120 m³
5,00 Kg
IP20

NEW!

F07 A46
01 White

384,00 €



LED 1x24W
WHITE 2700K Cri 80

0,120 m³
5,00 Kg
IP20

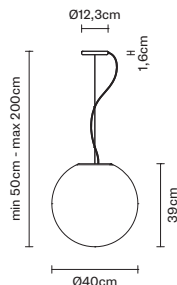

F07 A23
01 White

308,00 €

A10209C12

12x16,80 €

E27 1x205W
HSGST

0,150 m³
7,50 Kg
IP20

A10218C10

10x23,63 €

E27 1x30W
FBT

F07 A47
01 White

421,00 €



LED 1x24W
WHITE 3000K Cri 80

0,150 m³
7,50 Kg
IP20

NEW!

F07 A48
01 White

421,00 €



LED 1x24W
WHITE 2700K Cri 80

0,150 m³
7,50 Kg
IP20

LUMI F07

D&G Studio

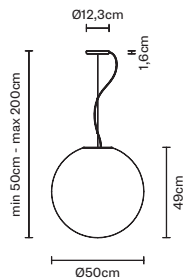

code

price €

bulb code
(not incl.)

bulb price €

electrification

technical info /
accessories incl.

F07 A25
01 White

456,00 €

A10209C12

12x16,80 €

E27 1x205W
HSGST

0,180 m³
8,50 Kg
IP20

A10218C10

10x23,63 €

E27 1x30W
FBT

F07 A49
01 White

570,00 €



LED 1x24W
WHITE 3000K Cri 80

0,180 m³
8,50 Kg
IP20

NEW!

F07 A50
01 White

570,00 €



LED 1x24W
WHITE 2700K Cri 80

0,180 m³
8,50 Kg
IP20

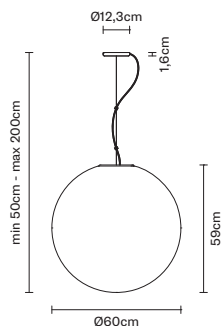

F07 A27
01 White

666,00 €

A10209C12

12x16,80 €

E27 1x205W
HSGST

0,208 m³
9,50 Kg
IP20

A10218C10

10x23,63 €

E27 1x30W
FBT

F07 A51
01 White

782,00 €



LED 1x24W
WHITE 3000K Cri 80

0,208 m³
9,50 Kg
IP20

NEW!

F07 A52
01 White

782,00 €



LED 1x24W
WHITE 2700K Cri 80

0,208 m³
9,50 Kg
IP20

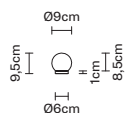

F07 B23
01 White

96,00 €

A11001C20

20x3,91 €

G9 1x20W
HSGS

0,030 m³
1,00 Kg
IP40

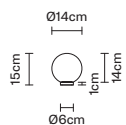

F07 B25
01 White

107,00 €

A11001C20

20x3,91 €

G9 1x20W
HSGS

0,030 m³
1,00 Kg
IP40

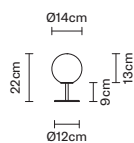

F07 B27
01 White

148,00 €

A11001C20



20x3,91 €

G9 1x20W
HSGS

0,030 m³
3,00 Kg
IP40

LUMI F07

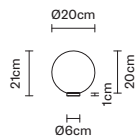
D&G Studio



code

price €

**bulb code
(not incl.)**

bulb price €

electrification

**technical info /
accessories incl.**

F07 B29
01 White

116,00 €

A11003C20

20x3,91 €

G9 1x48W
HSGS

0,030 m³
3,00 Kg
IP40

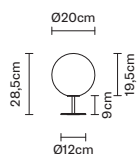

F07 B31
01 White

157,00 €

A11003C20

20x3,91 €

G9 1x48W
HSGS

0,030 m³
3,00 Kg
IP40

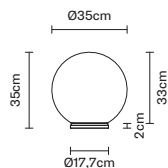

F07 B33
01 White

220,00 €

A10208C12

12x16,41 €

E27 1x150W
HSGST

0,120 m³
5,00 Kg
IP40

A10218C10

10x23,63 €

E27 1x30W
FBT

F07 B57
01 White

276,00 €



LED 1x17,5W
WHITE 3000K Cri 80

0,120 m³
5,00 Kg
IP40

NEW!

F07 B58
01 White

276,00 €



LED 1x17,5W
WHITE 2700K Cri 80

0,120 m³
5,00 Kg
IP40

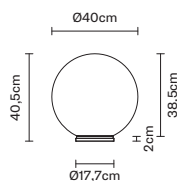

F07 B35
01 White

257,00 €

A10208C12

12x16,41 €

E27 1x150W
HSGST

0,150 m³
7,50 Kg
IP40

A10218C10

10x23,63 €

E27 1x30W
FBT

F07 B59
01 White

314,00 €



LED 1x17,5W
WHITE 3000K Cri 80

0,150 m³
7,50 Kg
IP40

NEW!

F07 B60
01 White

314,00 €



LED 1x17,5W
WHITE 2700K Cri 80

0,150 m³
7,50 Kg
IP40

LUMI F07

D&G Studio

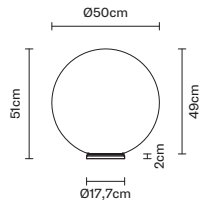

code

price €

**bulb code
(not incl.)**

bulb price €

electrification

**technical info /
accessories incl.**

F07 B37
01 White

404,00 €

A10209C12

12x16,80 €

E27 1x205W
HSGST

0,180 m³
8,50 Kg
IP40

A10218C10

10x23,63 €

E27 1x30W
FBT

F07 B61
01 White

463,00 €



LED 1x17,5W
WHITE 3000K Cri 80

0,180 m³
8,50 Kg
IP40

NEW!

F07 B62
01 White

463,00 €



LED 1x17,5W
WHITE 2700K Cri 80

0,180 m³
8,50 Kg
IP40

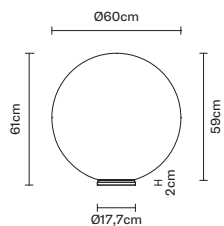

F07 B39
01 White

614,00 €

A10209C12

12x16,80 €

E27 1x205W
HSGST

0,208 m³
9,50 Kg
IP40

A10218C10

10x23,63 €

E27 1x30W
FBT

F07 B63
01 White

674,00 €



LED 1x17,5W
WHITE 3000K Cri 80

0,208 m³
9,50 Kg
IP40

NEW!

F07 B64
01 White

674,00 €



LED 1x17,5W
WHITE 2700K Cri 80

0,208 m³
9,50 Kg
IP40

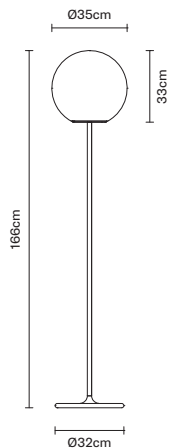

F07 C09
01 White

556,00 €

A10208C12

12x16,41 €

E27 1x150W
HSGST

0,450 m³
15,00 Kg
IP40

A10218C10

10x23,63 €

E27 1x30W
FBT

LUMI F07

D&G Studio

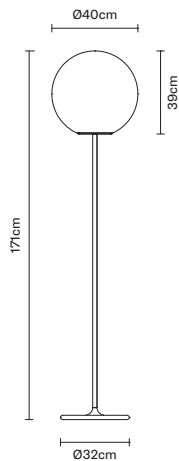

code

price €

bulb code
(not incl.)

bulb price €

electrification

technical info /
accessories incl.

F07 C11
01 White

593,00 €

A10208C12

12x16,41 €

E27 1x150W
HSGST

0,450 m³
15,00 Kg
IP40

A10218C10

10x23,63 €

E27 1x30W
FBT

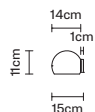

F07 D01
01 White

103,00 €

A11003C20

20x3,91 €

G9 1x48W
HSGS

0,030 m³
1,00 Kg
IP20

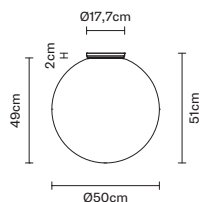

F07 E33
01 White

397,00 €

A10209C12

12x16,80 €

E27 1x205W
HSGST

0,180 m³
8,50 Kg
IP40

A10218C10

10x23,63 €

E27 1x30W
FBT

F07 E51
01 White

455,00 €



LED 1x17,5W
WHITE 3000K Cri 80

0,180 m³
8,50 Kg
IP40

NEW!

F07 E52
01 White

455,00 €



LED 1x17,5W
WHITE 2700K Cri 80

0,180 m³
8,50 Kg
IP40

LUMI F07

D&G Studio

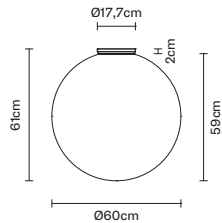

code

price €

bulb code
(not incl.)

bulb price €

electrification

technical info /
accessories incl.

F07 E09
01 White

607,00 €

A10209C12

12x16,80 €

E27 1x205W
HSGST

0,208 m³
9,50 Kg
IP40

A10218C10

10x23,63 €

E27 1x30W
FBT

F07 E15
01 White

668,00 €



LED 1x17,5W
WHITE 3000K Cri 80

0,208 m³
9,50 Kg
IP40



F07 E16
01 White

668,00 €



LED 1x17,5W
WHITE 2700K Cri 80

0,208 m³
9,50 Kg
IP40

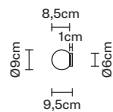

F07 G23
01 White

90,00 €

A11001C20

20x3,91 €

G9 1x20W
HSGS

0,030 m³
1,00 Kg
IP44

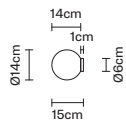

F07 G25
01 White

101,00 €

A11002C20

20x3,91 €

G9 1x33W
HSGS

0,030 m³
1,00 Kg
IP44

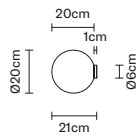

F07 G27
01 White

110,00 €

A11004C20

20x3,91 €

G9 1x60W
HSGS

0,030 m³
3,00 Kg
IP44

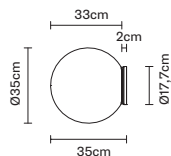

F07 G29
01 White

212,00 €

A10208C12

12x16,41 €

E27 1x150W
HSGST

0,120 m³
5,00 Kg
IP40

A10218C10

10x23,63 €

E27 1x30W
FBT

F07 G47
01 White

270,00 €



LED 1x17,5W
WHITE 3000K Cri 80

0,120 m³
5,00 Kg
IP40



F07 G48
01 White

270,00 €



LED 1x17,5W
WHITE 2700K Cri 80

0,120 m³
5,00 Kg
IP40

LUMI F07

D&G Studio

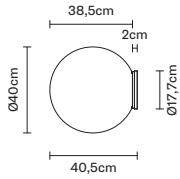

code

price €

bulb code
(not incl.)

bulb price €

electrification

technical info /
accessories incl.

F07 G31
01 White

250,00 €

A10208C12

12x16,41 €

E27 1x150W
HSGST

0,150 m³
7,50 Kg
IP40

A10218C10

10x23,63 €

E27 1x30W
FBT

F07 G49
01 White

307,00 €



LED 1x17,5W
WHITE 3000K Cri 80

0,150 m³
7,50 Kg
IP40

NEW!

F07 G50
01 White

307,00 €



LED 1x17,5W
WHITE 2700K Cri 80

0,150 m³
7,50 Kg
IP40

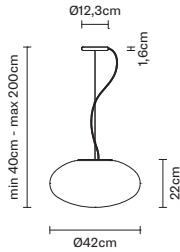

F07 A09
01 White

348,00 €

A10208C12

12x16,41 €

E27 1x150W
HSGST

0,108 m³
5,50 Kg
IP20

A10217C10

10x18,36 €

E27 1x22W
FBT

F07 A53
01 White

461,00 €



LED 1x24W
WHITE 3000K Cri 80

0,108 m³
5,50 Kg
IP20

NEW!

F07 A54
01 White

461,00 €



LED 1x24W
WHITE 2700K Cri 80

0,108 m³
5,50 Kg
IP20

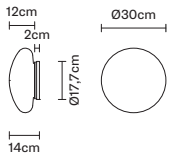

F07 G09
01 White

130,00 €

A10207C12

12x16,41 €

E27 1x100W
HSGST

0,035 m³
2,40 Kg
IP40

A10212C10

10x13,98 €

E27 1x15W
FBG

F07 G53
01 White

186,00 €



LED 1x17,5W
WHITE 3000K Cri 80

0,035 m³
2,40 Kg
IP40

NEW!

F07 G54
01 White

186,00 €



LED 1x17,5W
WHITE 2700K Cri 80

0,035 m³
2,40 Kg
IP40

LUMI F07

D&G Studio

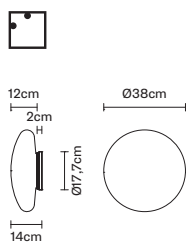

code	price €	bulb code (not incl.)	bulb price €	electrification	technical info / accessories incl.
F07 G11 01 White	152,00 €	A10208C12 	12x16,41 €	E27 1x150W HSGST	0,052 m ³ 3,40 Kg IP40
		A10213C10 	10x17,19 €	E27 1x20W FBG	
F07 G55 01 White	209,00 €			LED 1x17,5W WHITE 3000K Cri 80	0,052 m ³ 3,40 Kg IP40
NEW! F07 G56 01 White	209,00 €			LED 1x17,5W WHITE 2700K Cri 80	0,052 m ³ 3,40 Kg IP40

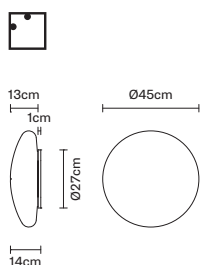

F07 G13 01 White	239,00 €	A10207C12 	12x16,41 €	E27 2x100W HSGST	0,069 m ³ 4,95 Kg IP40
		A10213C10 	10x17,19 €	E27 2x20W FBG	
F07 G57 01 White	296,00 €			LED 1x17,5W WHITE 3000K Cri 80	0,069 m ³ 4,95 Kg IP40
NEW! F07 G58 01 White	296,00 €			LED 1x17,5W WHITE 2700K Cri 80	0,069 m ³ 4,95 Kg IP40

MATISSE D79

Pamio Design

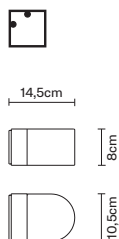

code	price €	bulb code (not incl.)	bulb price €	electrification	technical info / accessories incl.
D79 G01 01 White	212,00 €	A11003C20 	20x3,91 €	G9 1x48W HSGS η 76,20%	0,009 m ³ 1,60 Kg IP41
D79 G05 00 Transparent	212,00 €	A11003C20 	20x3,91 €	G9 1x48W HSGS η 76,20%	0,009 m ³ 1,60 Kg IP41

MIA F26

Federica Bubani

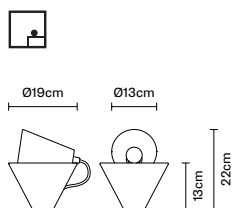

F26 B01 01 White	130,00 €	A10113C10 	10x4,69 €	E14 1x20W HSGSB	0,026 m ³ 2,10 Kg IP20
		A10105C10 	10x13,20 €	E14 1x6W FBG	

MONO&EASY D14

Massimo Sacconi

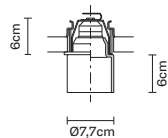

code

price €

**bulb code
(not incl.)**

bulb price €

electrification

**technical info /
accessories incl.**

D14 F06
01 White

85,00 €

A10801C10

10x6,25 €

GY6,35 1x50W
HSGS η 82,10%

0,004 m³
0,45 Kg
IP20

Accessori p. 200-201 / Accessories p. 200-201

D14 F16
01 White

74,00 €

A10101C10

10x4,69 €

E14 1x30W
HSGSB η 75,50%

0,004 m³
0,45 Kg
IP20

A10111C01

1x39,56 €

E14 1x3,5W

A10105C10

10x13,20 €

E14 1x6W
FBG

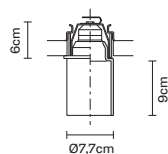

D14 F07
01 White

85,00 €

A10801C10

10x6,25 €

GY6,35 1x50W
HSGS η 80,20%

0,004 m³
0,50 Kg
IP20

Accessori p. 200-201 / Accessories p. 200-201

D14 F17
01 White

74,00 €

A10101C10

10x4,69 €

E14 1x30W
HSGSB η 67,60%

0,004 m³
0,50 Kg
IP20

A10111C01

1x39,56 €

E14 1x3,5W

A10105C10

10x13,20 €

E14 1x6W
FBG

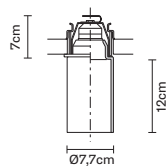

D14 F26
01 White

74,00 €

A11701C10

10x5,67 €

G24d-2 1x18W
FSD η 89,90%

0,005 m³
0,50 Kg
IP20

Accessori p. 200-201 / Accessories p. 200-201

MONO&EASY D14

Massimo Sacconi

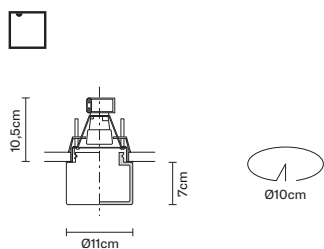

code	price €	bulb code (not incl.)	bulb price €	electrification	technical info / accessories incl.
D14 F36 01 White	86,00 €	A10202C10 	10x3,91 €	E27 1x46W HSGSB η 81,10%	0,005 m³ 0,90 Kg IP20 IP44
		A10210C10 	10x10,55 €	E27 1x11W FBT	
D14 F37 01 White	86,00 €	A11103C20 	20x6,06 €	GU10 1x75W HAGS η 48,90%	0,005 m³ 0,90 Kg IP20 IP44
		A11105C01 	1x52,72 €	GU10 1x5,5W	
D14 F38 01 White	86,00 €	A10704C10 	10x5,67 €	GU5,3 1x50W HRGS η 44,90%	0,005 m³ 0,90 Kg IP20 IP44
		A10705C01 	1x47,65 €	GU5,3 1x4W	
		Accessori p. 200-201 / Accessories p. 200-201			
D14 F39 01 White	86,00 €	A12201C10 	10x12,89 €	GX24q-2 1x18W FSQ η 51,50%	0,005 m³ 0,90 Kg IP20 IP44
		Accessori p. 200-201 / Accessories p. 200-201			
NEW! D14 F54 01 White	147,00 €			LED 14W-40° WHITE 3000K Cri 80	0,005 m³ 0,90 Kg IP20 IP44
		Accessori p. 200-201 / Accessories p. 200-201			
NEW! D14 F55 01 White	147,00 €			LED 14W-40° WHITE 2700K Cri 80	0,005 m³ 0,90 Kg IP20 IP44
		Accessori p. 200-201 / Accessories p. 200-201			
D14 F40 01 White	86,00 €	A10202C10 	10x3,91 €	E27 1x46W HSGSB η 83,10%	0,012 m³ 1,35 Kg IP20 IP44
		A10216C10 	10x15,66 €	E27 1x18W FBT	
NEW! D14 F56 01 White	147,00 €			LED 14W-40° WHITE 3000K Cri 80	0,012 m³ 1,35 Kg IP20 IP44
		Accessori p. 200-201 / Accessories p. 200-201			
NEW! D14 F57 01 White	147,00 €			LED 14W-40° WHITE 2700K Cri 80	0,012 m³ 1,35 Kg IP20 IP44
		Accessori p. 200-201 / Accessories p. 200-201			

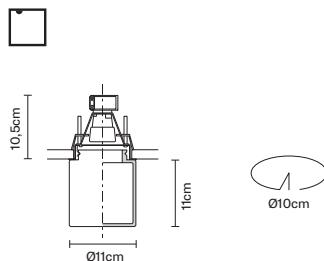

MULTISPOT F32

Flynn Talbot

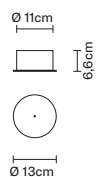

NEW! **F32 M01**
01 White

price €
123,00 €

bulb code (not incl.) **bulb price €** **electrification** **technical info / accessories incl.**

Spots non inclusi p. 116-117. Personalizzazione fori e dim. Su richiesta /
Spots not included p. 116-117. Holes and dim. Customization by request

0,006 m³
1,00 Kg
IP40

NEW! **F32 M02**
01 White

price €
107,00 €

Spots non inclusi p. 116-117. Personalizzazione fori e dim. Su richiesta /
Spots not included p. 116-117. Holes and dim. Customization by request

0,006 m³
1,00 Kg
IP40

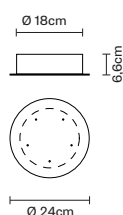

NEW! **F32 M03**
01 White

price €
244,00 €

Spots non inclusi p. 116-117. Personalizzazione fori e dim. Su richiesta /
Spots not included p. 116-117. Holes and dim. Customization by request

0,035 m³
2,00 Kg
IP40

NEW! **F32 M04**
01 White

price €
213,00 €

Spots non inclusi p. 116-117. Personalizzazione fori e dim. Su richiesta /
Spots not included p. 116-117. Holes and dim. Customization by request

0,035 m³
2,00 Kg
IP40

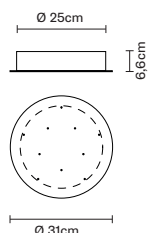

NEW! **F32 M05**
01 White

price €
345,00 €

Spots non inclusi p. 116-117. Personalizzazione fori e dim. Su richiesta /
Spots not included p. 116-117. Holes and dim. Customization by request

0,065 m³
3,00 Kg
IP40

NEW! **F32 M06**
01 White

price €
296,00 €

Spots non inclusi p. 116-117. Personalizzazione fori e dim. Su richiesta /
Spots not included p. 116-117. Holes and dim. Customization by request

0,065 m³
3,00 Kg
IP40

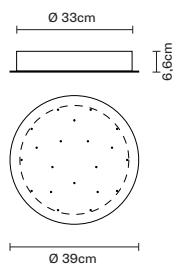

NEW! **F32 M07**
01 White

price €
464,00 €

Spots non inclusi p. 116-117. Personalizzazione fori e dim. Su richiesta /
Spots not included p. 116-117. Holes and dim. Customization by request

0,075 m³
5,00 Kg
IP40

NEW! **F32 M08**
01 White

price €
414,00 €

Spots non inclusi p. 116-117. Personalizzazione fori e dim. Su richiesta /
Spots not included p. 116-117. Holes and dim. Customization by request

0,075 m³
5,00 Kg
IP40

MULTISPOT F32

Flynn Talbot

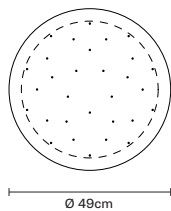
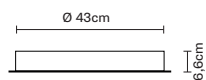

NEW!

F32 M09
01 White

751,00 €

bulb code
(not incl.)

bulb price €

electrification

technical info / accessories incl.

0,180 m³
7,00 Kg
IP40

Spots non inclusi p. 116-117. Personalizzazione fori e dim. Su richiesta /
Spots not included p. 116-117. Holes and dim. Customization by request

NEW!

F32 M10
01 White

620,00 €

0,180 m³
7,00 Kg
IP40

Spots non inclusi p. 116-117. Personalizzazione fori e dim. Su richiesta /
Spots not included p. 116-117. Holes and dim. Customization by request

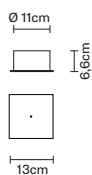

NEW!

F32 M21
01 White

156,00 €

0,006 m³
1,00 Kg
IP40

Spots non inclusi p. 116-117. Personalizzazione fori e dim. Su richiesta /
Spots not included p. 116-117. Holes and dim. Customization by request

NEW!

F32 M22
01 White

140,00 €

0,006 m³
1,00 Kg
IP40

Spots non inclusi p. 116-117. Personalizzazione fori e dim. Su richiesta /
Spots not included p. 116-117. Holes and dim. Customization by request

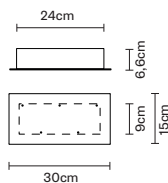

NEW!

F32 M23
01 White

276,00 €

0,040 m³
2,20 Kg
IP40

Spots non inclusi p. 116-117. Personalizzazione fori e dim. Su richiesta /
Spots not included p. 116-117. Holes and dim. Customization by request

NEW!

F32 M24
01 White

245,00 €

0,040 m³
2,20 Kg
IP40

Spots non inclusi p. 116-117. Personalizzazione fori e dim. Su richiesta /
Spots not included p. 116-117. Holes and dim. Customization by request

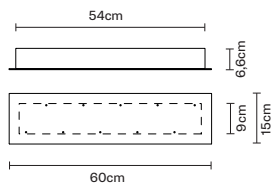

NEW!

F32 M25
01 White

418,00 €

0,070 m³
3,50 Kg
IP40

Spots non inclusi p. 116-117. Personalizzazione fori e dim. Su richiesta /
Spots not included p. 116-117. Holes and dim. Customization by request

NEW!

F32 M26
01 White

370,00 €

0,070 m³
3,50 Kg
IP40

Spots non inclusi p. 116-117. Personalizzazione fori e dim. Su richiesta /
Spots not included p. 116-117. Holes and dim. Customization by request

MULTISPOT F32

Flynn Talbot

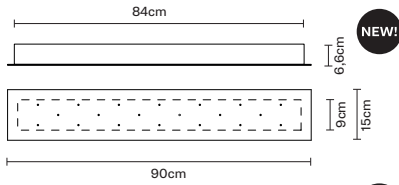

NEW!

code

price €

bulb code
(not incl.)

bulb price €

electrification

technical info /
accessories incl.

F32 M27
01 White

556,00 €

0,090 m³
5,00 Kg
IP40

Spots non inclusi p. 116-117. Personalizzazione fori e dim. Su richiesta /
Spots not included p. 116-117. Holes and dim. Customization by request

NEW!

F32 M28
01 White

505,00 €

0,090 m³
5,00 Kg
IP40

Spots non inclusi p. 116-117. Personalizzazione fori e dim. Su richiesta /
Spots not included p. 116-117. Holes and dim. Customization by request

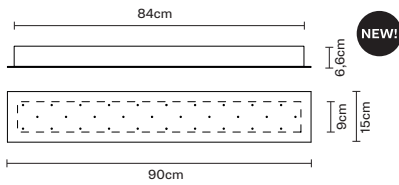

NEW!

F32 M29
01 White

715,00 €

0,090 m³
5,50 Kg
IP40

Spots non inclusi p. 116-117. Personalizzazione fori e dim. Su richiesta /
Spots not included p. 116-117. Holes and dim. Customization by request

NEW!

F32 M30
01 White

609,00 €

0,090 m³
5,50 Kg
IP40

Spots non inclusi p. 116-117. Personalizzazione fori e dim. Su richiesta /
Spots not included p. 116-117. Holes and dim. Customization by request

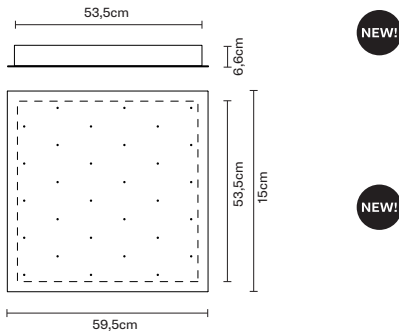

NEW!

F32 M41
01 White

806,00 €

0,180 m³
10,00 Kg
IP40

Spots non inclusi p. 116-117. Personalizzazione fori e dim. Su richiesta /
Spots not included p. 116-117. Holes and dim. Customization by request

NEW!

F32 M42
01 White

700,00 €

0,180 m³
10,00 Kg
IP40

Spots non inclusi p. 116-117. Personalizzazione fori e dim. Su richiesta /
Spots not included p. 116-117. Holes and dim. Customization by request

MULTISPOT F32

Flynn Talbot

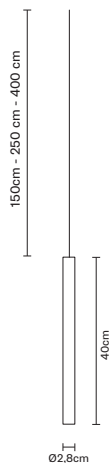

	code	price €	bulb code (not incl.)	bulb price €	electrification	technical info / accessories incl.
NEW!	F32 L01 00 Transparent	150,00 €			LED 700mA 3W WHITE 2700K Cri 80	0,011 m ³ 0,50 Kg IP40
			Cavo 150 cm / Cable 150 cm			
NEW!	F32 L02 00 Transparent	162,00 €			LED 700mA 3W WHITE 2700K Cri 80	0,011 m ³ 0,50 Kg IP40
			Cavo 250 cm / Cable 250 cm			
NEW!	F32 L03 00 Transparent	179,00 €			LED 700mA 3W WHITE 2700K Cri 80	0,011 m ³ 0,50 Kg IP40
			Cavo 400 cm / Cable 400 cm			



NEW!	F32 L06 00 Transparent	145,00 €	A10306C10 	10x1,98 €	G4 12V 5W	0,011 m ³ 1,50 Kg IP40
			A10307C01 	10x25,00 €	G4 12V max 5W	
			Cavo 150 cm / Cable 150 cm			
NEW!	F32 L07 00 Transparent	157,00 €	A10306C10 	10x1,98 €	G4 12V 5W	0,011 m ³ 1,50 Kg IP40
			A10307C01 	10x25,00 €	G4 12V max 5W	
			Cavo 250 cm / Cable 250 cm			
NEW!	F32 L08 00 Transparent	175,00 €	A10306C10 	10x1,98 €	G4 12V 5W	0,011 m ³ 1,50 Kg IP40
			A10307C01 	10x25,00 €	G4 12V max 5W	
			Cavo 400 cm / Cavo 400 cm			

MULTISPOT F32

Flynn Talbot



code	price €	bulb code (not incl.)	bulb price €	electrification	technical info / accessories incl.
NEW! F32 L11 00 Transparent	162,00 €			LED 700mA 3W WHITE 2700K Cri 80	0,007 m ³ 0,50 Kg IP40
Cavo 150 cm / Cable 150 cm					
NEW! F32 L12 00 Transparent	173,00 €			LED 700mA 3W WHITE 2700K Cri 80	0,007 m ³ 0,50 Kg IP40
Cavo 250 cm / Cable 250 cm					
NEW! F32 L13 00 Transparent	190,00 €			LED 700mA 3W WHITE 2700K Cri 80	0,007 m ³ 0,50 Kg IP40
Cavo 400 cm / Cable 400 cm					

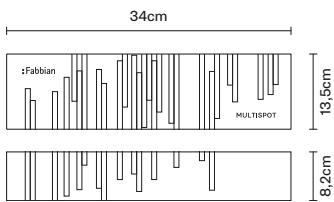

NEW! F32 Z99	198,00 €				0,005 m ³ 0,56 Kg
Kit Multispot Tooby					

MY MULTISPOT TOOBY

Personalizza l'altezza degli spot, alcuni esempi qui sotto.
Altri tipi di dimerizzazioni su richiesta. Alimentatori inclusi.
*/ Customize spots height, some examples here below.
Other kind of dimming by request. Dimmable ballasts included.*

LED 3W
700 mA
2700K
dim.

F32L0100 - 150cm
F32L0200 - 250cm
F32L0300 - 400cm

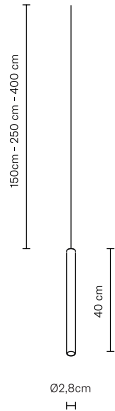

1 spot

F32M0101 700mA
Dim. Push button -
1..10V
Ø 13x6,6 cm



13 cm

5 spot

F32M0301 700mA
Dim. IGBT-TRIAC
Ø 24x6,6 cm

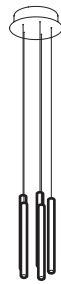
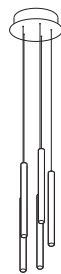

18 cm

24 cm

10 spot

F32M0501 700mA
Dim. IGBT-TRIAC
Ø 31x6,6 cm

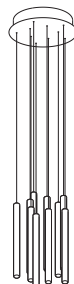
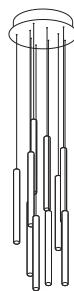

25 cm

31 cm

20 spot

F32M0701 700mA
Dim. IGBT-TRIAC
Ø 39x6,6 cm

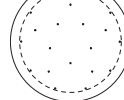
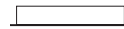
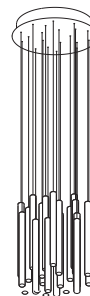
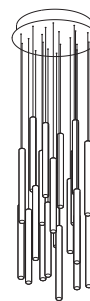

33 cm

39 cm

30 spot

F32M0901 700mA
Dim. IGBT-TRIAC
Ø 49x6,6 cm

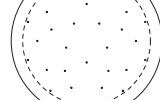
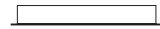
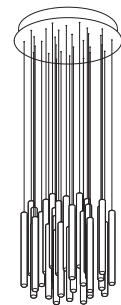
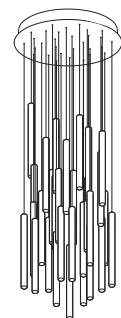

43 cm

49 cm

Personalizza la posizione degli spot / *Customize spots position*

3-5 spot

F32M0301 FM
Ø24 x 6,6 cm 700mA

6-10 spot

F32M0501 FM
Ø31 x 6,6 cm 700mA

11-20 spot

F32M0701 FM
Ø39 x 6,6 cm 700mA

21-30 spot

F32M0901 FM
Ø49 x 6,6 cm 700mA

1 spot

F32M2101
700mA
Dim. Push
button - 1..10V
13x13x6,6 cm

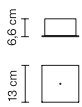

5 spot

F32M2301
700mA
Dim. IGBT-
TRIAC
30x15x6,6 cm

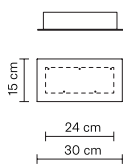
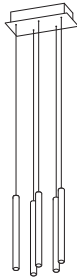
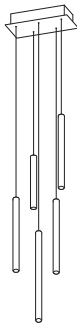

10 spot

F32M2501 700mA
Dim. IGBT-TRIAC
60x15x6,6 cm

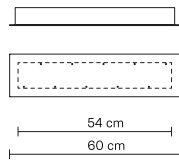
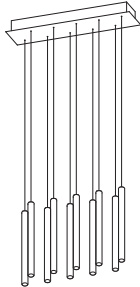
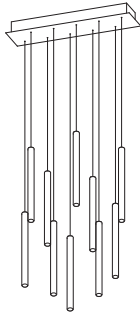

20 spot

F32M2701 700mA
Dim. IGBT-TRIAC
90x15x6,6 cm

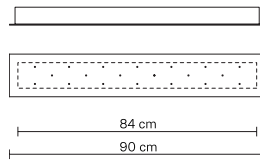
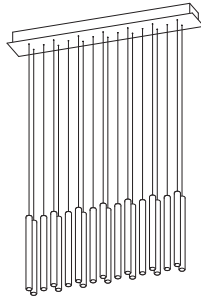
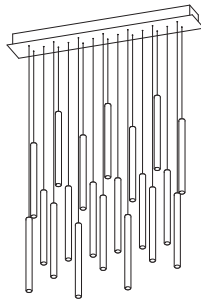

30 spot

F32M2901 700mA
Dim. IGBT-TRIAC
90x15x6,6 cm

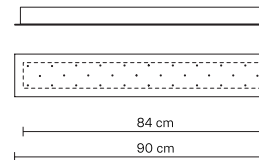
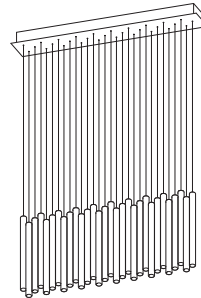
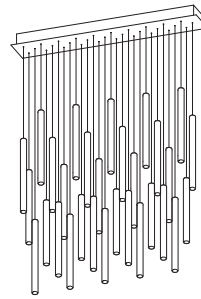

30 spot

F32M4101 700mA
Dim. IGBT-TRIAC
59,5x59,5x6,6 cm

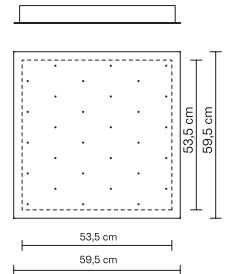
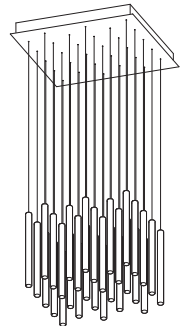
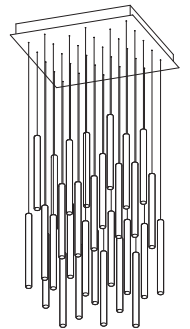

3-5 spot

F32M2301 FM
30 x 15 x 6,6 cm
700mA

6-10 spot

F32M2501 FM
60 x 15 x 6,6 cm
700mA

11-20 spot

F32M2701 FM
90 x 15 x 6,6 cm 700mA

21-30 spot

F32M2901 FM
90 x 15 x 6,6 cm 700mA

21-30 spot

F32M4101 FM
59,5 x 59,5 x 6,6 cm
700mA

MY MULTISPOT BELUGA

Personalizza l'altezza degli spot, alcuni esempi qui sotto.
Altri tipi di dimerazioni su richiesta. Alimentatori inclusi.
/ Customize spots height, some examples here below.
Other kind of dimming by request. Dimmable ballasts included.

G4 12V
max 5W
dimerabile con
possibilità di
utilizzare
lampadine a led.
*Dimmable with
the possibility to
use led bulbs.*

F32L0600 - 150cm
F32L0700 - 250cm
F32L0800 - 400cm

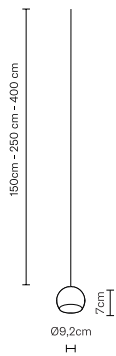

1 spot

F32M0201
Dim. Push button -
1..10V
Ø 13x6,6 cm



13 cm

5 spot

F32M0401
Dim. IGBT-TRIAC
Ø 24x6,6 cm

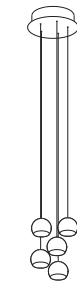
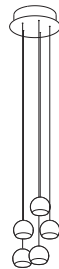

18 cm
24 cm

10 spot

F32M0601
Dim. IGBT-TRIAC
Ø 31x6,6 cm

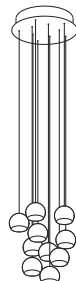
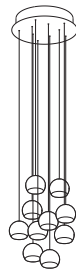

25 cm
31 cm

20 spot

F32M0801
Dim. IGBT-TRIAC
Ø 39x6,6 cm

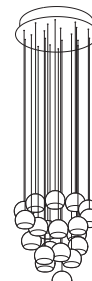
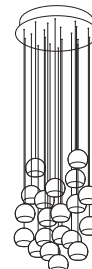

33 cm
39 cm

30 spot

F32M1001
Dim. IGBT-TRIAC
Ø 49x6,6 cm

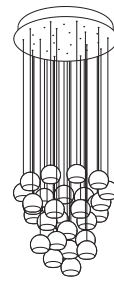
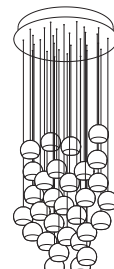

43 cm
49 cm

Personalizza la posizione degli spot / *Customize spots position*

3-5 spot

F32M0401 FM
Ø24 x 6,6 cm 12V

6-10 spot

F32M0601 FM
Ø31 x 6,6 cm 12V

11-20 spot

F32M0801 FM
Ø39 x 6,6 cm 12V

21-30 spot

F32M1001 FM
Ø49 x 6,6 cm 12V

1 spot

F32M2201
Dim. Push
button - 1..10V
13x13x6,6 cm

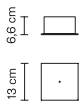

5 spot

F32M2401
Dim. IGBT-
TRIAC
30x15x6,6 cm

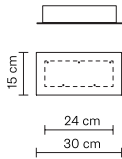
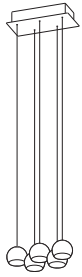
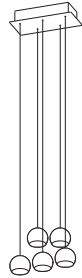

10 spot

F32M2601
Dim. IGBT-TRIAC
60x15x6,6 cm

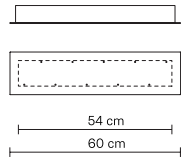
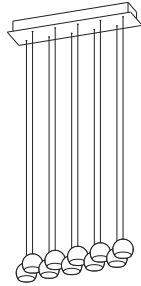
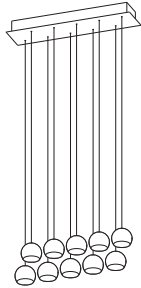

20 spot

F32M2801
Dim. IGBT-TRIAC
90x15x6,6 cm

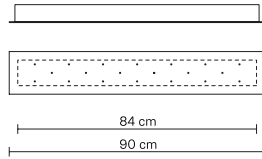
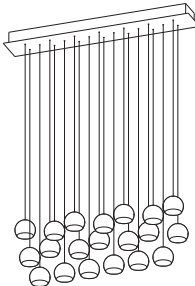
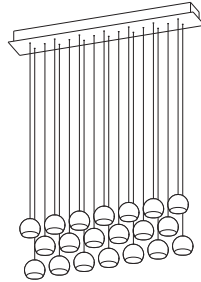

30 spot

F32M3001
Dim. IGBT-TRIAC
90x15x6,6 cm

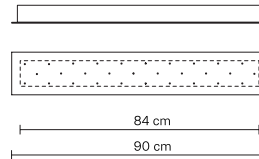
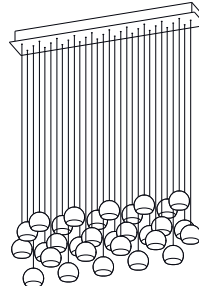
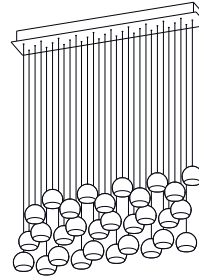

30 spot

F32M4201
Dim. IGBT-TRIAC
59,5x59,5x6,6 cm

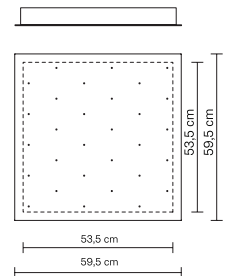
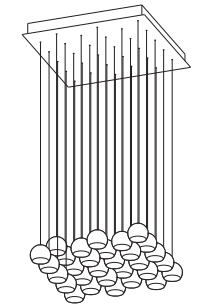
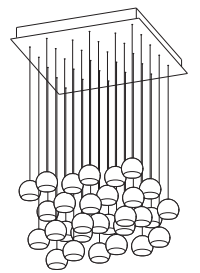

3-5 spot

F32M2401 FM
30 x 15 x 6,6 cm
12V

6-10 spot

F32M2601 FM
60 x 15 x 6,6 cm 12V

11-20 spot

F32M2801 FM
90 x 15 x 6,6 cm 12V

21-30 spot

F32M3001 FM
90 x 15 x 6,6 cm 12V

21-30 spot

F32M4201 FM
59,5 x 59,5 x 6,6 cm 12V

MY MULTISPOT POLAIR

Personalizza l'altezza degli spot, alcuni esempi qui sotto.
Altri tipi di dimerizzazioni su richiesta. Alimentatori inclusi.
/ Customize spots height, some examples here below.
Other kind of dimming by request. Dimmable ballasts included.

LED 3W
700 mA
2700K
dim.

F32L1100 - 150cm
F32L1200 - 250cm
F32L1300 - 400cm

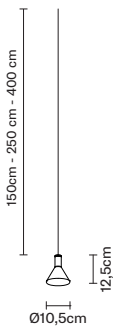

1 spot

F32M0101 700mA
Dim. Push button -
1..10V
Ø 13x6,6 cm

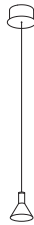

13 cm

5 spot

F32M0301 700mA
Dim. IGBT-TRIAC
Ø 24x6,6 cm

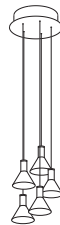

18 cm
24 cm

10 spot

F32M0501 700mA
Dim. IGBT-TRIAC
Ø 31x6,6 cm

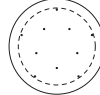
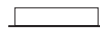
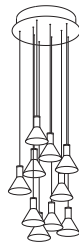

25 cm
31 cm

20 spot

F32M0701 700mA
Dim. IGBT-TRIAC
Ø 39x6,6 cm

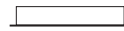

33 cm
39 cm

30 spot

F32M0901 700mA
Dim. IGBT-TRIAC
Ø 49x6,6 cm

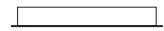
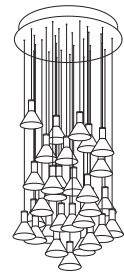

43 cm
49 cm

Personalizza la posizione degli spot / *Customize spots position*

3-5 spot

F32M0301 FM
Ø24 x 6,6 cm 700mA

6-10 spot

F32M0501 FM
Ø31 x 6,6 cm 700mA

11-20 spot

F32M0701 FM
Ø39 x 6,6 cm 700mA

21-30 spot

F32M0901 FM
Ø49 x 6,6 cm 700mA

1 spot

F32M2101
700mA
Dim. Push
button - 1..10V
13x13x6,6 cm

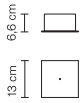

5 spot

F32M2301
700mA
Dim. IGBT-
TRIAC
30x15x6,6 cm

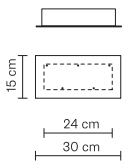
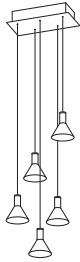

10 spot

F32M2501 700mA
Dim. IGBT-TRIAC
60x15x6,6 cm

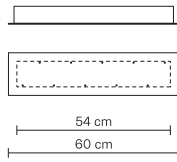
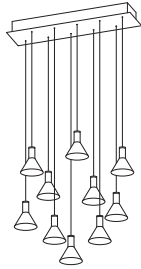

20 spot

F32M2701 700mA
Dim. IGBT-TRIAC
90x15x6,6 cm

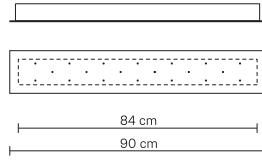
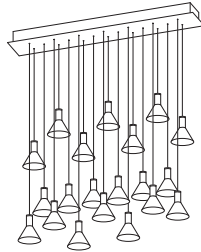

30 spot

F32M2901 700mA
Dim. IGBT-TRIAC
90x15x6,6 cm

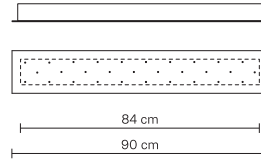
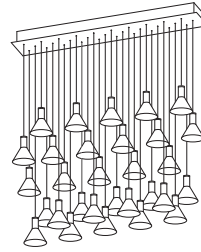

30 spot

F32M4101 700mA
Dim. IGBT-TRIAC
59,5x59,5x6,6 cm

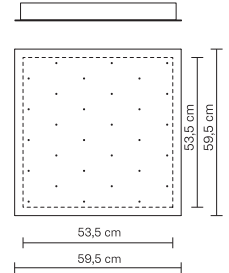
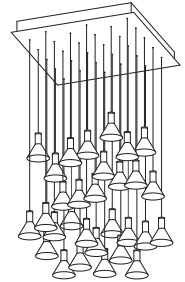

3-5 spot

F32M2301 FM
30 x 15 x 6,6 cm
700mA

6-10 spot

F32M2501 FM
60 x 15 x 6,6 cm
700mA

11-20 spot

F32M2701 FM
90 x 15 x 6,6 cm 700mA

21-30 spot

F32M2901 FM
90 x 15 x 6,6 cm 700mA

21-30 spot

F32M4101 FM
59,5 x 59,5 x 6,6 cm
700mA

NO MORE F06

Pio & Tito Toso

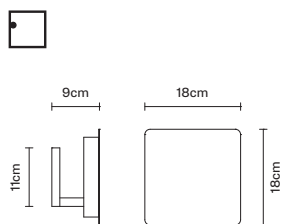

code

price €

bulb code
(not incl.)

bulb price €

electrification

technical info /
accessories incl.

F06 D01
01 White

169,00 €

A11503C20

20x7,42 €

R7s (78mm) 1x120W
HDG

0,013 m³
1,80 Kg
IP20

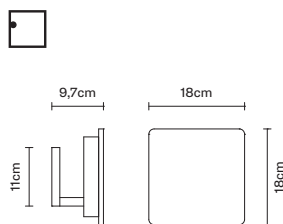

F06 D03
48 Dark wood
colour
69 Light wood
colour
70 Intermediate
wood colour

208,00 €

A11503C20

20x7,42 €

R7s (78mm) 1x120W
HDG

0,013 m³
1,80 Kg
IP20

ORBIS D70

Prospero Rasulo

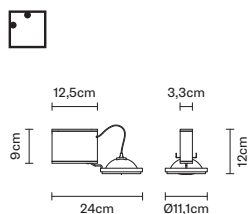

code

price €

bulb code
(not incl.)

bulb price €

electrification

technical info /
accessories incl.

D70 G01
01 White

162,00 €

A10602C06

6x13,28 €

G53 1x100W
HMGS η 100,00%

0,005 m³
1,20 Kg
IP20

D70 G01
15 Chrome

191,00 €

A10602C06

6x13,28 €

G53 1x100W
HMGS η 100,00%

0,005 m³
1,20 Kg
IP20

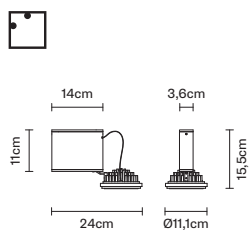

D70 G03
01 White

360,00 €



LED

LED 500mA 9x2W-25° 0,012 m³
WHITE 3000K Cri 80 1,30 Kg

IP20

D70 G03
15 Chrome

424,00 €



LED

LED 500mA 9x2W-25° 0,012 m³
WHITE 3000K Cri 80 1,30 Kg

IP20

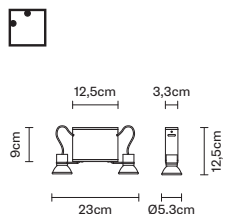

D70 G05
01 White

217,00 €

A10704C10

10x5,67 €

GU5,3 2x50W
HRGS η 100,00%

0,005 m³
1,20 Kg
IP20

A10706C01

LED

1x72,75 €

GU5,3 2x10W

D70 G05
15 Chrome

256,00 €

A10704C10

10x5,67 €

GU5,3 2x50W
HRGS η 100,00%

0,005 m³
1,20 Kg
IP20

A10706C01

LED

1x72,75 €

GU5,3 2x10W

ORBIS D70

Prospero Rasulo

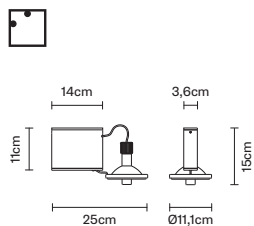

code

price €

bulb code
(not incl.)

bulb price €

electrification

technical info /
accessories incl.

D70 G07
01 White

274,00 €

A12702C01

1x79,28 €

GX8,5 1x70W
MR η 100,00%

0,012 m³
1,35 Kg
IP20

D70 G07
15 Chrome

322,00 €

A12702C01

1x79,28 €

GX8,5 1x70W
MR η 100,00%

0,012 m³
1,35 Kg
IP20

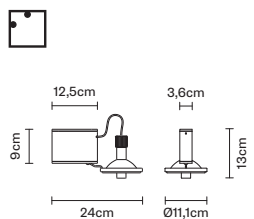

D70 G09
01 White

274,00 €

A12701C01

1x79,12 €

GX8,5 1x35W
MR η 100,00%

0,012 m³
1,00 Kg
IP20

D70 G09
15 Chrome

322,00 €

A12701C01

1x79,12 €

GX8,5 1x35W
MR η 100,00%

0,012 m³
1,00 Kg
IP20

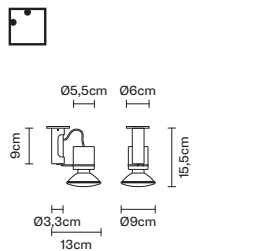

D70 G15
01 White

143,00 €

A10205C15

15x12,10 €

E27 1x100W
HAGS η 100,00%

0,005 m³
0,50 Kg
IP20

A10227C01

1x101,53 €

E27 1x14,5W

D70 G15
15 Chrome

168,00 €

A10205C15

15x12,10 €

E27 1x100W
HAGS η 100,00%

0,005 m³
0,50 Kg
IP20

A10227C01

1x101,53 €

E27 1x14,5W

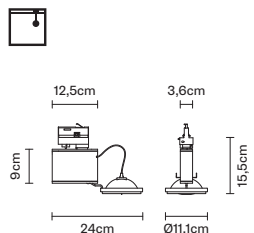

D70 J01
01 White

198,00 €

A10602C06

6x13,28 €

G53 1x100W
HMGS η 100,00%

0,005 m³
1,20 Kg
IP20

Binario p. 204 / Track p. 204

D70 J01
15 Chrome

233,00 €

A10602C06

6x13,28 €

G53 1x100W
HMGS η 100,00%

0,005 m³
1,20 Kg
IP20

Binario p. 204 / Track p. 204

ORBIS D70

Prospero Rasulo

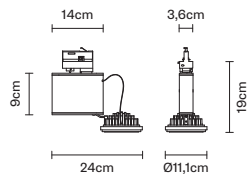

code

price €

bulb code
(not incl.)

bulb price €

electrification

technical info /
accessories incl.

D70 J03
01 White

398,00 €



LED 500mA 9x2W-25° 0,012 m³
WHITE 3000K Cri 80 1,30 Kg



Binario p. 204 / Track p. 204

D70 J03
15 Chrome

468,00 €



LED 500mA 9x2W-25° 0,012 m³
WHITE 3000K Cri 80 1,30 Kg



Binario p. 204 / Track p. 204

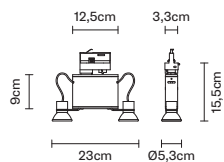

D70 J05
01 White

254,00 €



GU5,3 2x50W
HRGS η 100,00%

0,005 m³
1,20 Kg



Binario p. 204 / Track p. 204



GU5,3 2x10W

D70 J05
15 Chrome

299,00 €

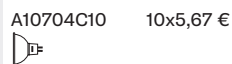

GU5,3 2x50W
HRGS η 100,00%

0,005 m³
1,20 Kg



Binario p. 204 / Track p. 204



GU5,3 2x10W

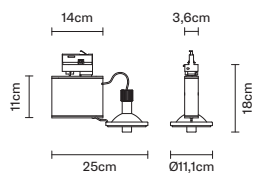

D70 J07
01 White

311,00 €

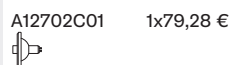

GX8,5 1x70W
MR η 100,00%

0,012 m³
1,35 Kg



Binario p. 204 / Track p. 204

D70 J07
15 Chrome

366,00 €

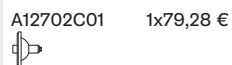

GX8,5 1x70W
MR η 100,00%

0,012 m³
1,35 Kg



Binario p. 204 / Track p. 204

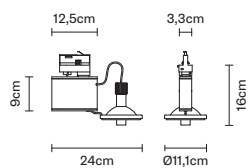

D70 J09
01 White

311,00 €

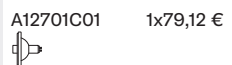

GX8,5 1x35W
MR η 100,00%

0,012 m³
1,00 Kg



Binario p. 204 / Track p. 204

D70 J09
15 Chrome

366,00 €

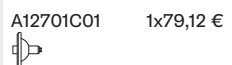

GX8,5 1x35W
MR η 100,00%

0,012 m³
1,00 Kg



Binario p. 204 / Track p. 204

ORBIS D70

Prospero Rasulo

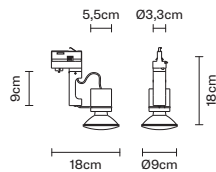

code

price €

bulb code
(not incl.)

bulb price €

electrification

technical info /
accessories incl.

D70 J15
01 White

174,00 €

A10205C15

15x12,10 €

E27 1x100W
HAGS η 100,00%

0,005 m³
0,50 Kg
IP20

A10227C01

1x101,53 €

E27 1x14,5W

Binario p. 204 / Track p. 204

D70 J15
15 Chrome

204,00 €

A10205C15

15x12,10 €

E27 1x100W
HAGS η 100,00%

0,005 m³
0,50 Kg
IP20

A10227C01

1x101,53 €

E27 1x14,5W

Binario p. 204 / Track p. 204

ORU F25

Vim & Vigor

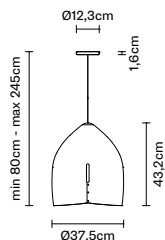

code

price €

bulb code
(not incl.)

bulb price €

electrification

technical info /
accessories incl.

F25 A01
03 Red
43 Green
73 Teal blue

539,00 €

A10208C12

12x16,41 €

E27 1x150W
HSGST

0,18 m³
5,50 Kg
IP20

A10229C01

1x19,53 €

E27 1x23W
FBC

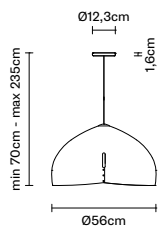

F25 A03
03 Red
43 Green
73 Teal blue

539,00 €

A10208C12

12x16,41 €

E27 1x150W
HSGST

0,18 m³
5,50 Kg
IP20

A10229C01

1x19,53 €

E27 1x23W
FBC

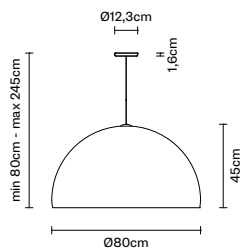

F25 A07
41 Copper

3.234,00 €

A10208C12

12x16,41 €

E27 3x150W
HSGST

0,44 m³
7,50 Kg
IP20

A10229C01

1x19,53 €

E27 3x23W
FBC

PADDLE F11

Benjamin Hubert

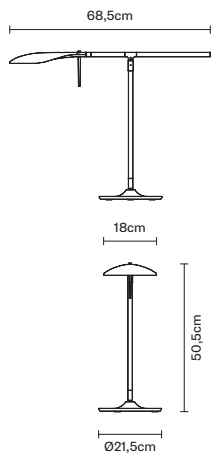

code

F11 B01
21 Anthracite

price €

273,00 €

bulb code
(not incl.)



bulb price €

electrification

LED 10W
WHITE 3000K Cri 80

technical info /
accessories incl.

0,095 m³
4,00 Kg
IP20

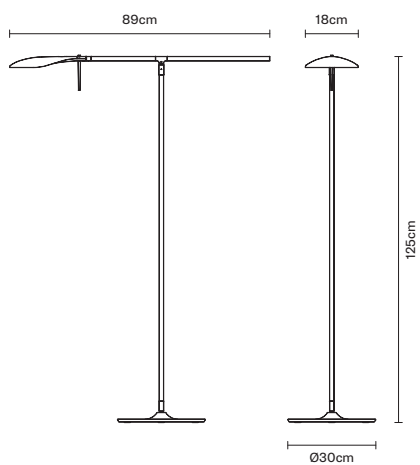

F11 C01
21 Anthracite

297,00 €



LED 10W
WHITE 3000K Cri 80

0,288 m³
7,00 Kg
IP20

PIVOT F39

Vittorio Massimo

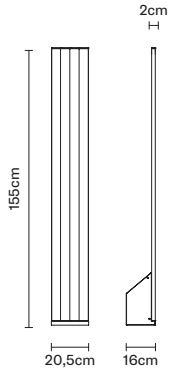

NEW!

code
—
F39 C01
01 White
21 Anthracite

price €
—
1.166,00 €

bulb code
(not incl.)



bulb price €

electrification

LED 150W
WHITE 3000K Cri 80

technical info / accessories incl.

0,135 m³
8,80 Kg
IP40

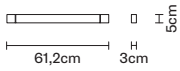

NEW!

F39 G01
01 White
21 Anthracite

216,00 €



LED 30W
WHITE 3000K Cri 80

0,007 m³
0,60 Kg
IP40

Accessori p. 200-201 / Accessories p. 200-201

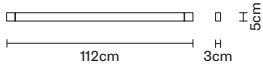

NEW!

F39 G03
01 White
21 Anthracite

273,00 €



LED 60W
WHITE 3000K Cri 80

0,010 m³
0,75 Kg
IP40

Accessori p. 200-201 / Accessories p. 200-201

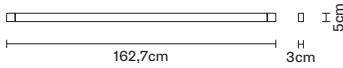

NEW!

F39 G05
01 White
21 Anthracite

328,00 €



LED 90W
WHITE 3000K Cri 80

0,014 m³
1,40 Kg
IP40

Accessori p. 200-201 / Accessories p. 200-201

PLANO D90

Studio Futura

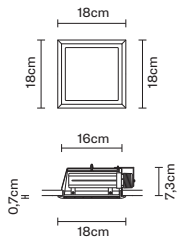

code

D90 F01
01 White
15 Chrome

price €

82,00 €

bulb code
(not incl.)



10x7,23 €

electrification

G24q-3 2x26W
FSQ

technical info / accessories incl.

0,008 m³
1,75 Kg
IP20
IP44

Accessori p. 200-201 / Accessories p. 200-201

PLANO D90

Studio Futura

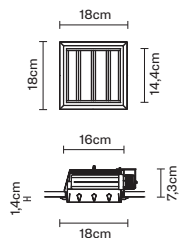

code

price €

**bulb code
(not incl.)**

bulb price €

electrification

**technical info /
accessories incl.**

D90 F02
01 White
15 Chrome

112,00 €

A12001C10

10x7,23 €

G24q-3 2x26W
FSQ

0,008 m³
1,75 Kg
IP20

Accessori p. 200-201 / Accessories p. 200-201

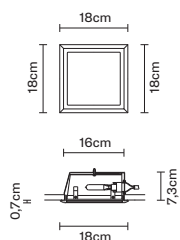

D90 F03
01 White
15 Chrome

82,00 €

A11302C01

1x46,86 €

G12 1x70W
MT

0,008 m³
1,70 Kg
IP20
IP44

Accessori p. 200-201 / Accessories p. 200-201

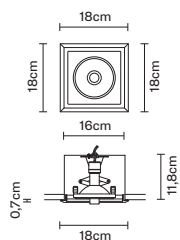

D90 F07
01 White
15 Chrome

205,00 €

A12702C01

1x79,28 €

GX8,5 1x70W
MR

0,008 m³
2,05 Kg
IP20 

Accessori p. 200-201 / Accessories p. 200-201

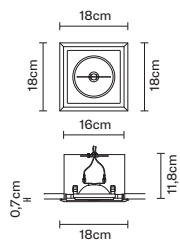

D90 F09
01 White
15 Chrome

186,00 €

A10602C06

6x13,28 €

G53 1x100W
HMGS

0,008 m³
1,80 Kg
IP20 

Accessori p. 200-201 / Accessories p. 200-201

POLAIR F36

Flynn Talbot

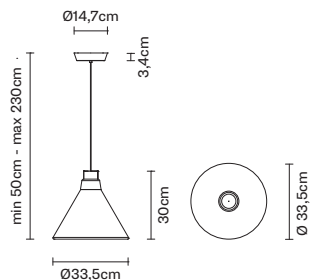

NEW!

code

price €

bulb code
(not incl.)

bulb price €

electrification

technical info /
accessories incl.

F36 A01
00 Transparent

539,00 €



LED 700mA 14W
WHITE 3000K Cri 80

0,120 m³
3,00 Kg
IP20

NEW!

F36 A02
00 Transparent

539,00 €



LED 700mA 14W
WHITE 2700K Cri 80

0,120 m³
3,00 Kg
IP20

PUÀ F37

Pellegrini + Mengato Design

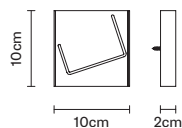

NEW!

F37 G01
01 White
02 Black
14 Satin-finish
burnished

108,00 €



LED 4,5W
WHITE 3000K Cri 80

0,002 m³
0,20 Kg
IP20

PULSE F03

A.Saggia & V.Sommella

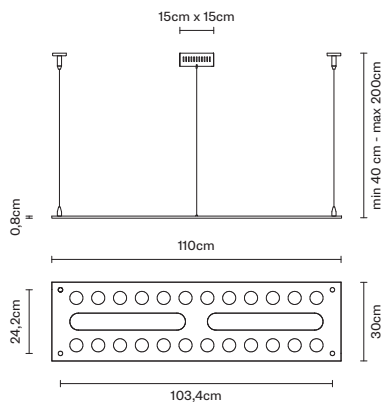

code

price €

bulb code
(not incl.)

bulb price €

electrification

technical info /
accessories incl.

F03 A01
00 Transparent

2.324,00 €



LED G4 ac/dc- 12V
24x1,5W-160°
WHITE 3000K Cri 80

0,132 m³
20,00 Kg
IP20

PULSE F03

A.Saggia & V.Sommella

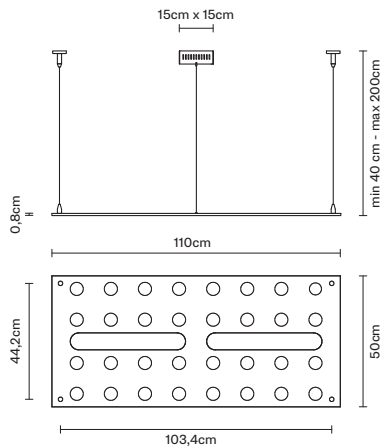

code

price €

bulb code
(not incl.)

bulb price €

electrification

technical info /
accessories incl.

F03 A03
00 Transparent

2.854,00 €



LED G4 ac/dc- 12V
32x1,5W-160°
WHITE 3000K Cri 80

0,132 m³
27,00 Kg
IP20

QUADRILED F18

Marc Sadler

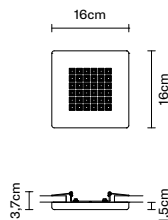

code

price €

bulb code
(not incl.)

bulb price €

electrification

technical info /
accessories incl.

F18 F01
00 Transparent

195,00 €



LED 15W
WHITE 3000K Cri 80

0,005 m³
0,71 Kg
IP44

Accessori p. 200-201 / Accessories p. 200-201

F18 F02
03 Red
05 Aquamarine
47 Amber

206,00 €



LED 15W
WHITE 3000K Cri 80

0,005 m³
0,71 Kg
IP44

Accessori p. 200-201 / Accessories p. 200-201

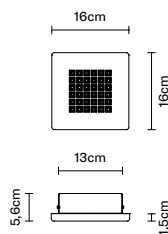

F18 G01
00 Transparent

278,00 €



LED 15W
WHITE 3000K Cri 80

0,005 m³
1,11 Kg
IP40

F18 G02
03 Red
05 Aquamarine
47 Amber

289,00 €



LED 15W
WHITE 3000K Cri 80

0,005 m³
1,11 Kg
IP40

QUARTER F38

Pellegrini+Mengato Design

	code	price €	bulb code (not incl.)	bulb price €	electrification	technical info / accessories incl.
	NEW! F38 G01 01 White 02 Black 14 Satin-finish burnished	163,00 €			LED 2x4,5W WHITE 2700K Cri 80	0,007 m ³ 1,10 Kg IP40
	NEW! F38 G03 01 White 02 Black 14 Satin-finish burnished	218,00 €			LED 3x4,5W WHITE 2700K Cri 80	0,010 m ³ 1,40 Kg IP40
	NEW! F38 G05 01 White 02 Black 14 Satin-finish burnished	311,00 €			LED 5x4,5W WHITE 2700K Cri 80	0,015 m ³ 2,80 Kg IP40
	NEW! F38 G07 01 White 02 Black 14 Satin-finish burnished	138,00 €			LED 1x4,5W WHITE 2700K Cri 80	0,006 m ³ 0,60 Kg IP40
	NEW! F38 G09 01 White 02 Black 14 Satin-finish burnished	262,00 €			LED 3x4,5W WHITE 2700K Cri 80	0,024 m ³ 1,70 Kg IP40
	NEW! F38 G11 01 White 02 Black 14 Satin-finish burnished	387,00 €			LED 5x4,5W WHITE 2700K Cri 80	0,036 m ³ 2,50 Kg IP40

QUARTER F38

Pellegrini+Mengato Design

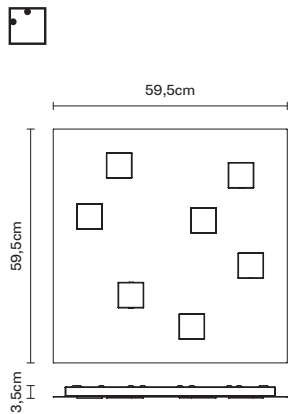

NEW!

code

F38 G13

01 White

02 Black

14 Satin-finish
burnished

price €

530,00 €

bulb code
(not incl.)



bulb price €

electrification

LED 7x4,5W
WHITE 2700K Cri 80

technical info /
accessories incl.

0,180 m³
6,50 Kg
IP40

ROOFER F12

Benjamin Hubert

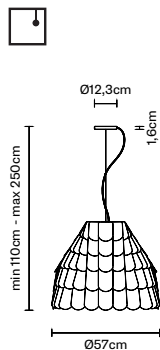

code

F12 A01

01 White

21 Anthracite

32 Orange

43 Green

price €

523,00 €

bulb code
(not incl.)

A10209C12



bulb price €

12x16,80 €

electrification

E27 1x205W
HSGST

technical info /
accessories incl.

0,380 m³
5,50 Kg
IP20

A10218C10



10x23,63 €

E27 1x30W
FBT

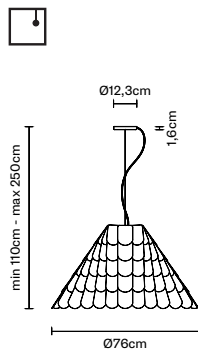

F12 A03

01 White

21 Anthracite

32 Orange

43 Green

price €

566,00 €

A10209C12



12x16,80 €

E27 1x205W
HSGST

0,380 m³
5,50 Kg
IP20

A10218C10



10x23,63 €

E27 1x30W
FBT

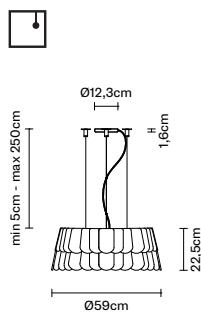

F12 A05

01 White

21 Anthracite

32 Orange

43 Green

price €

515,00 €

A10217C10



10x18,36 €

E27 6x22W
FBT

0,100 m³
4,00 Kg
IP20

ROOFER F12

Benjamin Hubert

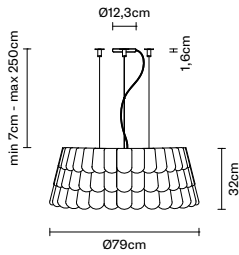

code

price €

bulb code
(not incl.)

bulb price €

electrification

technical info /
accessories incl.

F12 A07

854,00 €

A10218C10

10x23,63 €

E27 6x30W
FBT

0,240 m³
6,50 Kg
IP20

01 White
21 Anthracite
32 Orange
43 Green

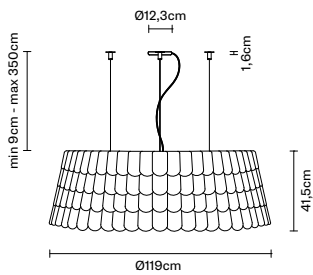

F12 A09

1.375,00 €

A10218C10

10x23,63 €

E27 12x30W
FBT

0,680 m³
11,00 Kg
IP20

01 White
21 Anthracite
32 Orange
43 Green



SLOT F15

Studio Futura

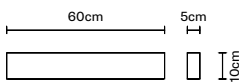

code

price €

bulb code
(not incl.)

bulb price €

electrification

technical info /
accessories incl.

F15 D01

371,00 €

A10505C04

4x24,22 €

G5 2x24W
FD

0,008 m³
2,30 Kg
IP40

01 White



F15 D01

349,00 €

A10505C04

4x24,22 €

G5 2x24W
FD

0,008 m³
2,30 Kg
IP40

61 Brilliant
aluminium



NEW!

F15 D02

458,00 €

A10505C04

LED

LED 30W
WHITE 3000K Cri>80

0,008 m³
2,30 Kg
IP40

01 White



NEW!

F15 D02

436,00 €

A10505C04

LED

LED 30W
WHITE 3000K Cri>80

0,008 m³
2,30 Kg
IP40



61 Brilliant
aluminium

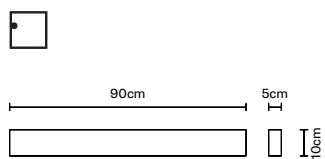

SLOT F15

Studio Futura



code	price €	bulb code (not incl.)	bulb price €	electrification	technical info / accessories incl.
F15 D03 01 White	443,00 €	A10506C04 	4x28,71 €	G5 2x39W FD	0,010 m ³ 3,00 Kg IP40
F15 D03 61 Brilliant aluminium	410,00 €	A10506C04 	4x28,71 €	G5 2x39W FD	0,010 m ³ 3,00 Kg IP40
NEW! F15 D04 01 White	530,00 €	 LED		LED 50W WHITE 3000K Cri>80	0,010 m ³ 3,00 Kg IP40
NEW! F15 D04 61 Brilliant aluminium	497,00 €	 LED		LED 50W WHITE 3000K Cri>80	0,010 m ³ 3,00 Kg IP40

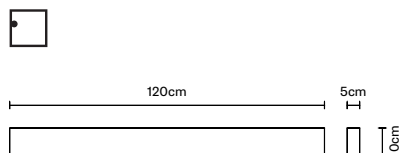

F15 D05 01 White	532,00 €	A10507C04 	4x28,71 €	G5 2x54W FD	0,015 m ³ 4,00 Kg IP40
F15 D05 61 Brilliant aluminium	487,00 €	A10507C04 	4x28,71 €	G5 2x54W FD	0,015 m ³ 4,00 Kg IP40
NEW! F15 D06 01 White	638,00 €	 LED		LED 60W WHITE 3000K Cri>80	0,015 m ³ 4,00 Kg IP40
NEW! F15 D06 61 Brilliant aluminium	594,00 €	 LED		LED 60W WHITE 3000K Cri>80	0,015 m ³ 4,00 Kg IP40

SLOT F15

Studio Futura



9cm



9cm



15cm

	code	price €	bulb code (not incl.)	bulb price €	electrification	technical info / accessories incl.
	F15 E01 01 White	112,00 €	A11103C20 	20x6,06 €	GU10 1x75W HAGS	0,002 m ³ 0,90 Kg IP20
	F15 E01 61 Brilliant aluminium	112,00 €	A11103C20 	20x6,06 €	GU10 1x75W HAGS	0,002 m ³ 0,90 Kg IP20
NEW!	F15 E02 01 White	191,00 €	 LED		LED 13W WHITE 3000K Cri>80	0,002 m ³ 0,90 Kg IP20
NEW!	F15 E02 61 Brilliant aluminium	180,00 €	 LED		LED 13W WHITE 3000K Cri>80	0,002 m ³ 0,90 Kg IP20
NEW!	F15 E52 01 White	191,00 €	 LED		LED 13W WHITE 2700K Cri>80	0,002 m ³ 0,90 Kg IP20
NEW!	F15 E52 61 Brilliant aluminium	180,00 €	 LED		LED 13W WHITE 2700K Cri>80	0,002 m ³ 0,90 Kg IP20







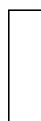

9cm



9cm



30cm

	F15 E03 01 White	134,00 €	A11103C20 	20x6,06 €	GU10 1x75W HAGS	0,003 m ³ 1,20 Kg IP20
	F15 E03 61 Brilliant aluminium	134,00 €	A11103C20 	20x6,06 €	GU10 1x75W HAGS	0,003 m ³ 1,20 Kg IP20
NEW!	F15 E04 01 White	215,00 €	 LED		LED 13W WHITE 3000K Cri>80	0,003 m ³ 1,20 Kg IP20
NEW!	F15 E04 61 Brilliant aluminium	202,00 €	 LED		LED 13W WHITE 3000K Cri>80	0,003 m ³ 1,20 Kg IP20
NEW!	F15 E54 01 White	215,00 €	 LED		LED 13W WHITE 2700K Cri>80	0,003 m ³ 1,20 Kg IP20
NEW!	F15 E54 61 Brilliant aluminium	202,00 €	 LED		LED 13W WHITE 2700K Cri>80	0,003 m ³ 1,20 Kg IP20

SLOT F15

Studio Futura

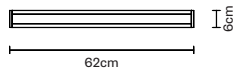

code	price €	bulb code (not incl.)	bulb price €	electrification	technical info / accessories incl.
F15 F01 01 White	290,00 €	A10505C04 	4x24,22 €	G5 1x24W FD	0,008 m ³ 1,00 Kg IP40
F15 F01 61 Brilliant aluminium	271,00 €	A10505C04 	4x24,22 €	G5 1x24W FD	0,008 m ³ 1,00 Kg IP40
NEW! F15 F02 01 White	363,00 €	LED		LED 15W WHITE 3000K Cri>80	0,008 m ³ 1,00 Kg IP40
NEW! F15 F02 61 Brilliant aluminium	344,00 €	LED		LED 15W WHITE 3000K Cri>80	0,008 m ³ 1,00 Kg IP40

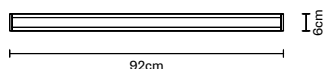

F15 F03 01 White	342,00 €	A10506C04 	4x28,71 €	G5 1x39W FD	0,010 m ³ 1,40 Kg IP40
F15 F03 61 Brilliant aluminium	313,00 €	A10506C04 	4x28,71 €	G5 1x39W FD	0,010 m ³ 1,40 Kg IP40
NEW! F15 F04 01 White	422,00 €	LED		LED 25W WHITE 3000K Cri>80	0,010 m ³ 1,40 Kg IP40
NEW! F15 F04 61 Brilliant aluminium	393,00 €	LED		LED 25W WHITE 3000K Cri>80	0,010 m ³ 1,40 Kg IP40

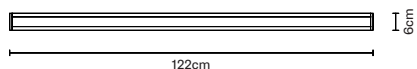

F15 F05 01 White	395,00 €	A10507C04 	4x28,71 €	G5 1x54W FD	0,015 m ³ 1,90 Kg IP40
F15 F05 61 Brilliant aluminium	359,00 €	A10507C04 	4x28,71 €	G5 1x54W FD	0,015 m ³ 1,90 Kg IP40
NEW! F15 F06 01 White	486,00 €	LED		LED 30W WHITE 3000K Cri>80	0,015 m ³ 1,90 Kg IP40
NEW! F15 F06 61 Brilliant aluminium	450,00 €	LED		LED 30W WHITE 3000K Cri>80	0,015 m ³ 1,90 Kg IP40

SNAKE D63

Francesco Lucchese

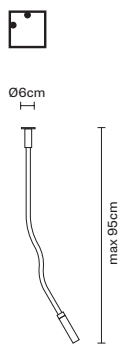

code	price €	bulb code (not incl.)	bulb price €	electrification	technical info / accessories incl.
D63 G01 01 White 02 Black 31 Blue 32 Orange 43 Green	298,00 €	A11003C20 	20x3,91 €	G9 1x48W HSGS η 91,70%	0,007 m ³ 1,85 Kg IP40

SOSPESA D42

Paolo De Lucchi - Lisa Bellon

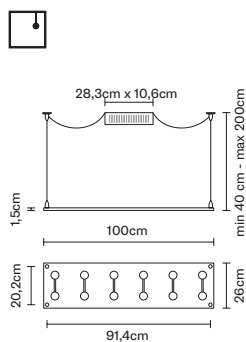

code	price €	bulb code (not incl.)	bulb price €	electrification	technical info / accessories incl.
D42 A01 00 Transparent	1.183,00 €	A10302C10 	10x0,94 €	G4 12x20W HSGS η 79,60%	0,058 m ³ 15,00 Kg IP20

D42 A15 00 Transparent	1.524,00 €			LED G4 ac/dc- 12V 12x1,5W-160° WHITE 3000K Cri 80	0,058 m ³ 15,00 Kg IP20
----------------------------------	-------------------	--	--	---	--

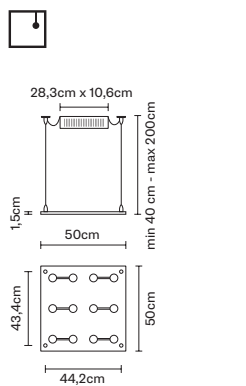

D42 A03 00 Transparent	1.183,00 €	A10302C10 	10x0,94 €	G4 12x20W HSGS η 85,50%	0,052 m ³ 14,72 Kg IP20
----------------------------------	-------------------	---------------	-----------	----------------------------	--

D42 A17 00 Transparent	1.524,00 €			LED G4 ac/dc- 12V 12x1,5W-160° WHITE 3000K Cri 80	0,052 m ³ 14,72 Kg IP20
----------------------------------	-------------------	--	--	---	--

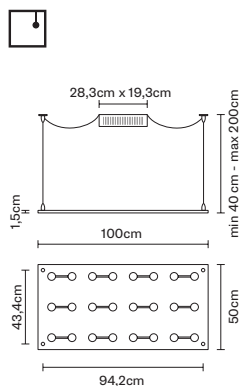

D42 A05 00 Transparent	2.450,00 €	A10302C10 	10x0,94 €	G4 24x20W HSGS η 85,50%	0,132 m ³ 27,65 Kg IP20
----------------------------------	-------------------	---------------	-----------	----------------------------	--

D42 A19 00 Transparent	3.131,00 €			LED G4 ac/dc- 12V 24x1,5W-160° WHITE 3000K Cri 80	0,132 m ³ 27,65 Kg IP20
----------------------------------	-------------------	--	--	---	--

SOSPESA D42

Paolo De Lucchi - Lisa Bellon

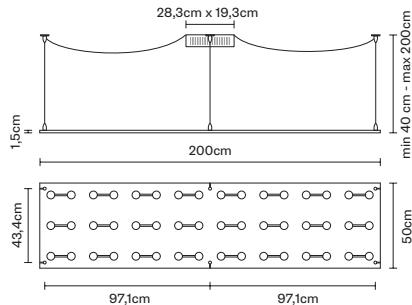

code

price €

bulb code
(not incl.)

bulb price €

electrification

technical info /
accessories incl.

D42 A09
00 Transparent

6.419,00 €

A10301C10

10x0,94 €

G4 48x10W
HSGS η 85,50%

0,499 m³
35,84 Kg
IP20

D42 A21
00 Transparent

7.792,00 €

LED G4 ac/dc- 12V
48x1,5W-160°
WHITE 3000K Cri 80

0,499 m³
35,84 Kg
IP20

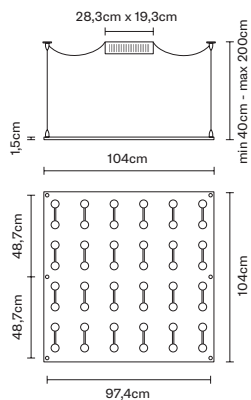

D42 A11
00 Transparent

6.419,00 €

A10301C10

10x0,94 €

G4 48x10W
HSGS η 85,50%

0,499 m³
35,84 Kg
IP20

D42 A23
00 Transparent

7.792,00 €

LED G4 ac/dc- 12V
48x1,5W-160°
WHITE 3000K Cri 80

0,499 m³
35,84 Kg
IP20

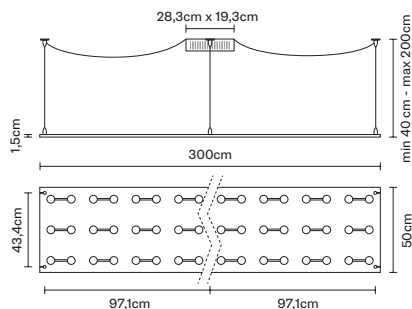

D42 A13
00 Transparent

12.569,00 €

A10301C10

10x0,94 €

G4 72x10W
HSGS η 85,50%

0,619 m³
41,50 Kg
IP20

D42 A25
00 Transparent

14.653,00 €

LED G4 ac/dc- 12V
72x1,5W-160°
WHITE 3000K Cri 80

0,619 m³
41,50 Kg
IP20

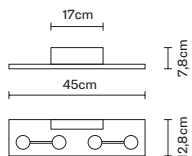

D42 D01
00 Transparent

386,00 €

A10304C10

10x2,77 €

G4 4x35W
HSGS η 98,10%

0,017 m³
3,10 Kg
IP20

D42 D09
00 Transparent

499,00 €

LED G4 ac/dc- 12V
4x1,5W-160°
WHITE 3000K Cri 80

0,017 m³
3,10 Kg
IP20

SOSPESA D42

Paolo De Lucchi - Lisa Bellon

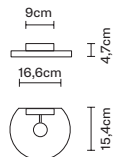

code

price €

bulb code
(not incl.)

bulb price €

electrification

technical info /
accessories incl.

D42 D03
00 Transparent

185,00 €

A11004C20

20x3,91 €

G9 1x60W
HSGS η 71,40%

0,009 m³
1,12 Kg
IP20

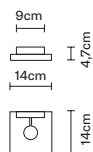

D42 D05
00 Transparent

185,00 €

A11004C20

20x3,91 €

G9 1x60W
HSGS η 71,40%

0,009 m³
1,12 Kg
IP20

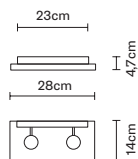

D42 D07
00 Transparent

318,00 €

A11003C20

20x3,91 €

G9 2x48W
HSGS η 71,40%

0,018 m³
2,15 Kg
IP20

SPIRITO DI VENEZIA F10

Gianpaolo Canova

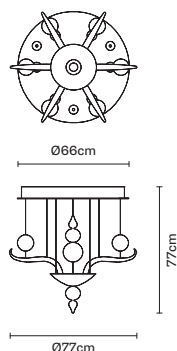

code

price €

bulb code
(not incl.)

bulb price €

electrification

technical info /
accessories incl.

F10 A01
00 Transparent

2.140,00 €

A11102C20

20x4,69 €

GU10 6x50W
HAGS

0,550 m³
17,50 Kg
IP20

In esaurimento / While stocks last

F10 A01
01 White

2.219,00 €

A11102C20

20x4,69 €

GU10 6x50W
HAGS

0,550 m³
17,50 Kg
IP20

In esaurimento / While stocks last

SPIRITO DI VENEZIA F10

Gianpaolo Canova

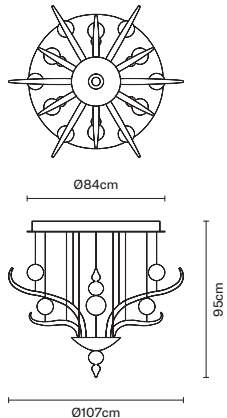

code	price €	bulb code (not incl.)	bulb price €	electrification	technical info / accessories incl.
F10 A03 00 Transparent	4.319,00 €	A11102C20 	20x4,69 €	GU10 9x50W HAGS	0,650 m ³ 25,30 Kg IP20
In esaurimento / While stocks last					
F10 A03 01 White	4.643,00 €	A11102C20 	20x4,69 €	GU10 9x50W HAGS	0,650 m ³ 25,30 Kg IP20
In esaurimento / While stocks last					

STICK F23

Matali Crasset

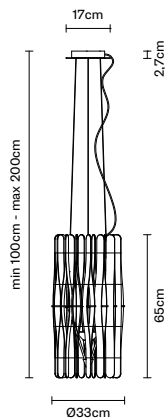

code	price €	bulb code (not incl.)	bulb price €	electrification	technical info / accessories incl.
F23 A01 69 Light wood colour	655,00 €	A10229C01 	1x19,53 €	E27 1x23W FBC	0,130 m ³ 4,00 Kg IP20
NEW! F23 A06 69 Light wood colour	765,00 €			LED 1x8,7W WHITE 3000K Cri>80	0,130 m ³ 4,00 Kg
				LED 1x13W WHITE 3000K	IP20
NEW! F23 A56 69 Light wood colour	765,00 €			LED 1x8,7W WHITE 2700K Cri>80	0,130 m ³ 4,00 Kg
				LED 1x13W WHITE 2700K	IP20

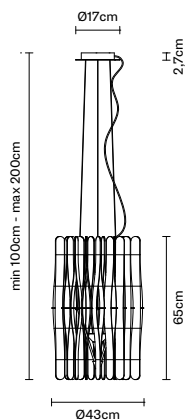

F23 A02 69 Light wood colour	788,00 €	A10229C01 	1x19,53 €	E27 1x23W FBC	0,280 m ³ 5,00 Kg IP20
NEW! F23 A07 69 Light wood colour	898,00 €			LED 1x8,7W WHITE 3000K Cri>80	0,280 m ³ 5,00 Kg
				LED 1x24W WHITE 3000K	IP20
NEW! F23 A57 69 Light wood colour	898,00 €			LED 1x8,7W WHITE 2700K Cri>80	0,280 m ³ 5,00 Kg
				LED 1x24W WHITE 2700K	IP20

STICK F23

Matali Crasset

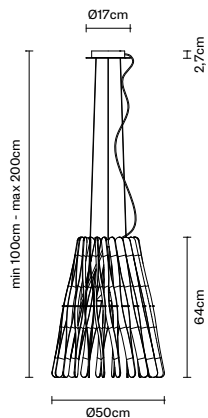

code

price €

bulb code
(not incl.)

bulb price €

electrification

technical info /
accessories incl.

F23 A03

69 Light wood
colour

788,00 €

A10229C01

1x19,53 €

E27 1x23W
FBC

0,280 m³
5,00 Kg
IP20

NEW!

F23 A08

69 Light wood
colour

898,00 €



LED 1x8,7W
WHITE 3000K Cri>80
LED 1x24W
WHITE 3000K

0,280 m³
5,00 Kg
IP20

NEW!

F23 A58

69 Light wood
colour

898,00 €



LED 1x8,7W
WHITE 2700K Cri>80
LED 1x24W
WHITE 2700K

0,280 m³
5,00 Kg
IP20

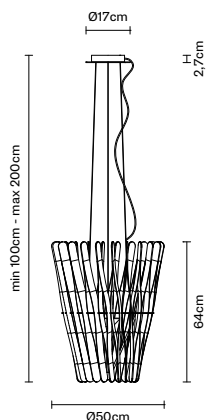

F23 A04

69 Light wood
colour

788,00 €

A10229C01

1x19,53 €

E27 1x23W
FBC

0,280 m³
5,00 Kg
IP20

NEW!

F23 A09

69 Light wood
colour

898,00 €



LED 1x8,7W
WHITE 3000K Cri>80
LED 1x24W
WHITE 3000K

0,280 m³
5,00 Kg
IP20

NEW!

F23 A59

69 Light wood
colour

898,00 €



LED 1x8,7W
WHITE 2700K Cri>80
LED 1x24W
WHITE 2700K

0,280 m³
5,00 Kg
IP20

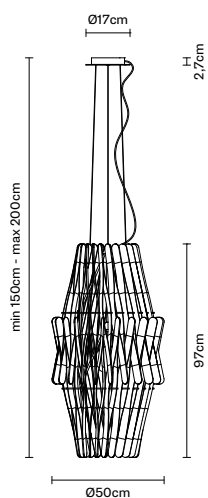

F23 A05

69 Light wood
colour

1.338,00 €

A10229C01

1x19,53 €

E27 1x23W
FBC

0,360 m³
7,00 Kg
IP20

NEW!

F23 A10

69 Light wood
colour

1.448,00 €



LED 1x8,7W
WHITE 3000K Cri>80
LED 1x24W
WHITE 3000K

0,360 m³
7,00 Kg
IP20

NEW!

F23 A60

69 Light wood
colour

1.448,00 €



LED 1x8,7W
WHITE 2700K Cri>80
LED 1x24W
WHITE 2700K

0,360 m³
7,00 Kg
IP20

STICK F23

Matali Crasset

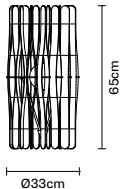

	code	price €	bulb code (not incl.)	bulb price €	electrification	technical info / accessories incl.
	F23 B01 69 Light wood colour	560,00 €	A10229C01 	1x19,53 €	E27 1x23W FBC	0,130 m ³ 4,00 Kg IP20
NEW!	F23 B02 69 Light wood colour	670,00 €	LED		LED 1x8,7W WHITE 3000K Cri>80	0,130 m ³ 4,00 Kg IP20
NEW!	F23 B52 69 Light wood colour	670,00 €	LED		LED 1x8,7W WHITE 2700K Cri>80	0,130 m ³ 4,00 Kg IP20

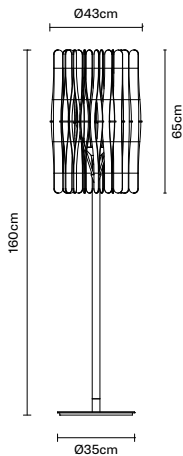

	F23 C01 69 Light wood colour	927,00 €	A10229C01 	1x19,53 €	E27 1x23W FBC	0,720 m ³ 11,00 Kg IP20
NEW!	F23 C05 69 Light wood colour	1.037,00 €	LED		LED 1x8,7W WHITE 3000K Cri>80	0,720 m ³ 11,00 Kg IP20
NEW!	F23 C55 69 Light wood colour	1.037,00 €	LED		LED 1x8,7W WHITE 2700K Cri>80	0,720 m ³ 11,00 Kg IP20

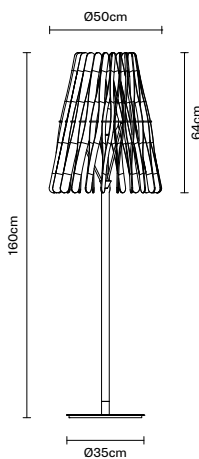

	F23 C02 69 Light wood colour	927,00 €	A10229C01 	1x19,53 €	E27 1x23W FBC	0,720 m ³ 11,00 Kg IP20
NEW!	F23 C06 69 Light wood colour	1.037,00 €	LED		LED 1x8,7W WHITE 3000K Cri>80	0,720 m ³ 11,00 Kg IP20
NEW!	F23 C56 69 Light wood colour	1.037,00 €	LED		LED 1x8,7W WHITE 2700K Cri>80	0,720 m ³ 11,00 Kg IP20

STICK F23

Matali Crasset

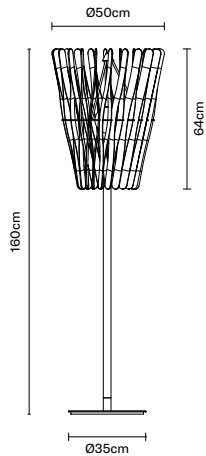

code

price €

bulb code
(not incl.)

bulb price €

electrification

technical info /
accessories incl.

F23 C03

69 Light wood
colour

927,00 €

A10229C01

1x19,53 €

E27 1x23W
FBC

0,720 m³
11,00 Kg
IP20

NEW!

F23 C07

69 Light wood
colour

1.037,00 €



LED 1x8,7W
WHITE 3000K Cri>80
LED 1x24W
WHITE 3000K

0,720 m³
11,00 Kg

IP20

NEW!

F23 C57

69 Light wood
colour

1.037,00 €



LED 1x8,7W
WHITE 2700K Cri>80
LED 1x24W
WHITE 2700K

0,720 m³
11,00 Kg

IP20

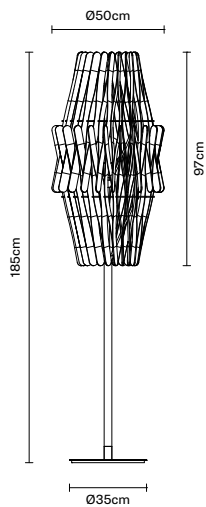

F23 C04

69 Light wood
colour

1.484,00 €

A10229C01

1x19,53 €

E27 1x23W
FBC

0,720 m³
13,00 Kg
IP20

NEW!

F23 C08

69 Light wood
colour

1.594,00 €



LED 1x8,7W
WHITE 3000K Cri>80
LED 1x24W
WHITE 3000K

0,720 m³
13,00 Kg

IP20

NEW!

F23 C58

69 Light wood
colour

1.594,00 €



LED 1x8,7W
WHITE 2700K Cri>80
LED 1x24W
WHITE 2700K

0,720 m³
13,00 Kg

IP20

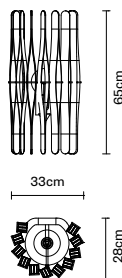

F23 D01

69 Light wood
colour

546,00 €

A10229C01

1x19,53 €

E27 1x23W
FBC

0,130 m³
4,00 Kg
IP20

NEW!

F23 D02

69 Light wood
colour

656,00 €



LED 1x8,7W
WHITE 3000K Cri>80
LED 1x13W
WHITE 3000K

0,130 m³
4,00 Kg

IP20

NEW!

F23 D52

69 Light wood
colour

656,00 €



LED 1x8,7W
WHITE 2700K Cri>80
LED 1x13W
WHITE 2700K

0,130 m³
4,00 Kg

IP20

SWING D48

Francesco Lucchese

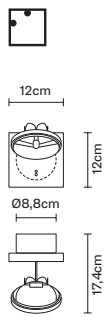

code

price €

bulb code
(not incl.)

bulb price €

electrification

technical info /
accessories incl.

D48 G01
51 Opaque
chrome

192,00 €

A10601C06

6x14,53 €

G53 1x50W
HMGS η 100,00%

0,007 m³
0,80 Kg
IP20 

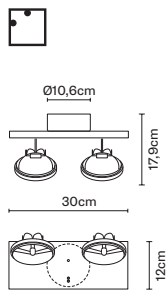

D48 G03
51 Opaque
chrome

284,00 €

A10601C06

6x14,53 €

G53 2x50W
HMGS η 100,00%

0,012 m³
1,50 Kg
IP20 

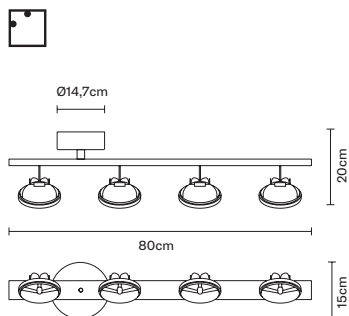

D48 G05
51 Opaque
chrome

527,00 €

A10601C06



6x14,53 €

G53 4x50W
HMGS η 100,00%

0,062 m³
6,50 Kg
IP20 

TEOREMA D09

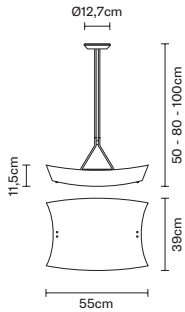
Giampiero Derai



code

D09 A01
01 White

price €

551,00 €

bulb code
(not incl.)

A11507C20



bulb price €

20x7,03 €

electrification

R7s (118mm) 1x230W
HDG η 87,10%

technical info /
accessories incl.

0,073 m³
4,50 Kg
IP20

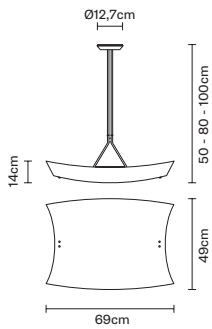

D09 A13
01 White

647,00 €

A11507C20



20x7,03 €

R7s (118mm) 1x230W
HDG η 86,60%

0,130 m³
6,70 Kg
IP20

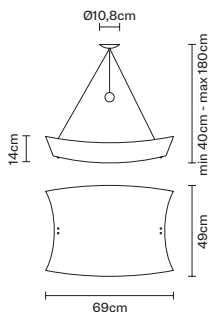

D09 A15
01 White

640,00 €

A11507C20



20x7,03 €

R7s (118mm) 1x230W
HDG η 82,40%

0,130 m³
6,20 Kg
IP20

TEOREMA D09

Giampiero Derai

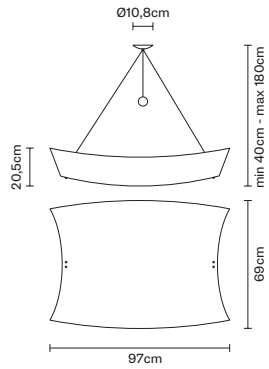

code

price €

bulb code
(not incl.)

bulb price €

electrification

technical info /
accessories incl.

D09 A17
01 White

817,00 €

A11507C20

20x7,03 €

R7s (118mm) 1x230W
HDG η 82,40%

0,270 m³
12,15 Kg
IP20

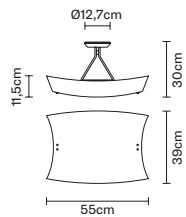

D09 E01
01 White

551,00 €

A11507C20

20x7,03 €

R7s (118mm) 1x230W
HDG η 87,10%

0,073 m³
4,50 Kg
IP20

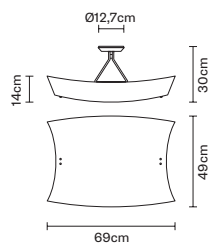

D09 E11
01 White

647,00 €

A11507C20

20x7,03 €

R7s (118mm) 1x230W
HDG η 87,10%

0,130 m³
6,70 Kg
IP20

TEOREMA D09

Giampiero Derai

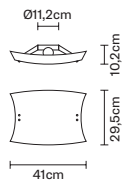

code

price €

bulb code
(not incl.)

bulb price €

electrification

technical info /
accessories incl.

D09 G01
01 White

298,00 €

A11505C20

20x6,25 €

R7s (118mm) 1x120W
HDG η 71,30%

0,037 m³
2,40 Kg
IP20

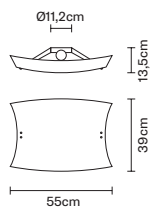

D09 G03
01 White

448,00 €

A11506C20

20x6,25 €

R7s (118mm) 1x160W
HDG η 71,30%

0,073 m³
3,80 Kg
IP20

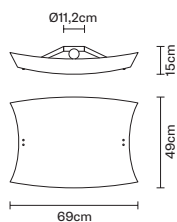

D09 G05
01 White

581,00 €

A11506C20

20x6,25 €

R7s (118mm) 1x160W
HDG η 71,30%

0,130 m³
5,90 Kg
IP20

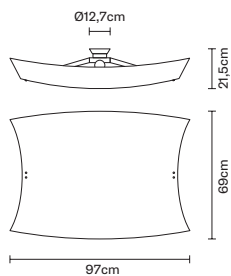

D09 G07
01 White

748,00 €

A11507C20

20x7,03 €

R7s (118mm) 1x230W
HDG η 71,30%

0,270 m³
12,50 Kg
IP20

TILE D95

Pamio Design

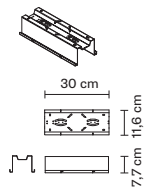

NEW!

D95 M11
63 Painted gray

price €
98,00 €

bulb code (not incl.)
A11102C20

bulb price €
20x4,69 €

electrification
GU10 Starter 2x50W
HAGS

technical info / accessories incl.
0,010 m³
1,50 Kg
IP20

Starter / Starter

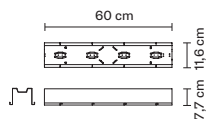

NEW!

D95 M12
63 Painted gray

price €
67,00 €

A11102C20

20x4,69 €

GU10 2x50W
HAGS

0,010 m³
1,50 Kg
IP20

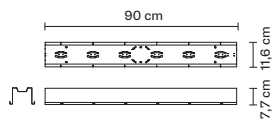

NEW!

D95 M13
63 Painted gray

price €
125,00 €

A11102C20

20x4,69 €

GU10 4x50W
HAGS

0,015 m³
2,50 Kg
IP20

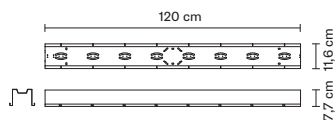

NEW!

D95 M14
63 Painted gray

price €
180,00 €

A11102C20

20x4,69 €

GU10 6x50W
HAGS

0,020 m³
3,00 Kg
IP20

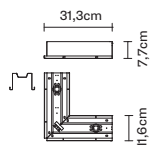

NEW!

D95 M15
63 Painted gray

price €
221,00 €

A11102C20

20x4,69 €

GU10 8x50W
HAGS

0,020 m³
3,50 Kg
IP20

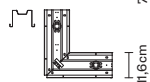

NEW!

D95 M16
63 Painted gray

price €
197,00 €

A11102C20

20x4,69 €

GU10 Starter 3x50W
HAGS

0,020 m³
2,20 Kg
IP20

TILE D95

Pamio Design

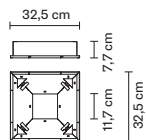

NEW!

code
—
D95 M17
63 Painted gray

price €
—
251,00 €

bulb code
(not incl.)
—
A11102C20

bulb price €
—
20x4,69 €

electrification
—
GU10 Starter 4x50W
HAGS

technical info /
accessories incl.
—
0,020 m³
3,00 Kg
IP20

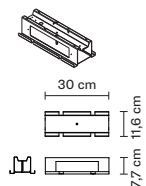

NEW!

D95 M01
63 Painted gray

157,00 €

Starter. Barretta LED non incl. p. 157. Alim. non incl. p. 200-201 / Starter. LED bar not incl. p. 157. Alim. not incl. p. 200-201

0,010 m³
1,50 Kg
IP20

NEW!

D95 M02
63 Painted gray

267,00 €

Starter. Barretta LED non incl. p. 157. 1 Alim. Incluso. Altre dim. su richiesta / Starter. LED bar not incl. p. 157. 1 Alim. Included. Other dim. by request

0,010 m³
1,50 Kg
IP20

NEW!

D95 M03
63 Painted gray

377,00 €

Starter. Barretta LED non incl. p. 157. 2 Alim. Incluso. Altre dim. su richiesta / Starter. LED bar not incl. p. 157. 2 Alim. Included. Other dim. by request

0,010 m³
1,50 Kg
IP20

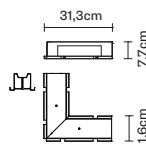

NEW!

D95 M06
63 Painted gray

490,00 €

Starter. Barretta LED non incl. p. 157. 2 Alim. Incluso. Altre dim. su richiesta / Starter. LED bar not incl. p. 157. 2 Alim. Included. Other dim. by request

0,020 m³
2,20 Kg
IP20

TILE D95

Pamio Design

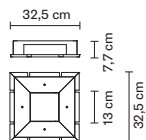

NEW!

code
D95 M07
63 Painted gray

price €
790,00 €

bulb code
(not incl.)

bulb price €

electrification

technical info /
accessories incl.

0,020 m³
3,00 Kg
IP20

Starter. Barretta LED non incl. p. 157. 4 Alim. Incluso. Altre dim. su richiesta /
Starter. LED bar not incl. p. 157. 4 Alim. Included. Other dim. by request

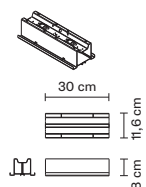

NEW!

D95 M22
63 Painted gray

67,00 €

0,010 m³
1,50 Kg
IP20

Strip LED non incl. p. 158. Alim. non incl. p. 200-201 / Strip LED not incl. p. 158.
Alim. not incl. p. 200-201

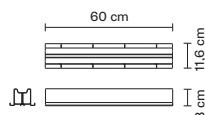

NEW!

D95 M23
63 Painted gray

125,00 €

0,015 m³
2,50 Kg
IP20

Strip LED non incl. p. 158. Alim. non incl. p. 200-201 / Strip LED not incl. p. 158.
Alim. not incl. p. 200-201

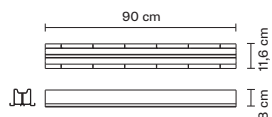

NEW!

D95 M24
63 Painted gray

180,00 €

0,020 m³
3,00 Kg
IP20

Strip LED non incl. p. 158. Alim. non incl. p. 200-201 / Strip LED not incl. p. 158.
Alim. not incl. p. 200-201

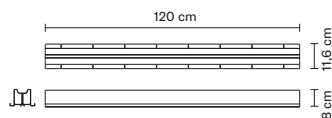

NEW!

D95 M25
63 Painted gray

221,00 €

0,020 m³
3,50 Kg
IP20

Strip LED non incl. p. 158. Alim. non incl. p. 200-201 / Strip LED not incl. p. 158.
Alim. not incl. p. 200-201

TILE D95

Pamio Design

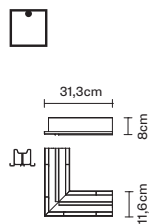

NEW!

code
—
D95 M26
63 Painted gray

price €
—
197,00 €

bulb code
(not incl.)

bulb price €

electrification

technical info /
accessories incl.

0,020 m³
2,20 Kg
IP20

Strip LED non incl. p. 158. Alim. non incl. P. / Strip LED not incl. p. 158. Alim. not incl. p. 200-201

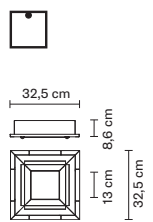

NEW!

D95 M27
63 Painted gray

251,00 €

0,020 m³
3,00 Kg
IP20

Strip LED inclusa. Alim. Incluso / Strip LED included. Alim. Included

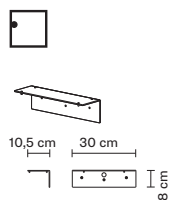

NEW!

D95 Z02
63 Painted gray

33,00 €

0,010 m³
1,00 Kg

Accessorio parete per L1/2 GU10 - L1/2 LED bar - L1/2 LED strip / wall accessory for L1/2 GU10 - L1/2 LED bar - L1/2 LED strip

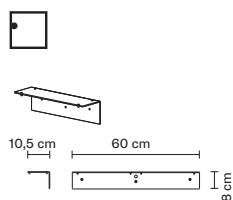

NEW!

D95 Z03
63 Painted gray

50,00 €

0,015 m³
1,50 Kg

Accessorio parete per L1/2 GU10 - L1/2 LED bar - L1/2 LED strip / wall accessory for L1/2 GU10 - L1/2 LED bar - L1/2 LED strip

TILE D95

Pamio Design

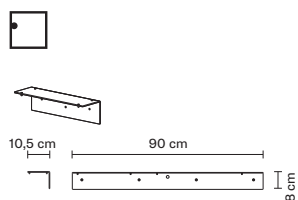

NEW!

D95 Z04
63 Painted gray

price €
85,00 €

bulb code
(not incl.)

bulb price €

electrification

technical info /
accessories incl.

0,020 m³
2,00 Kg

Accessorio parete per L1/2 GU10 - L1/2 LED bar - L1/2 LED strip / wall accessory for L1/2 GU10 - L1/2 LED bar - L1/2 LED strip

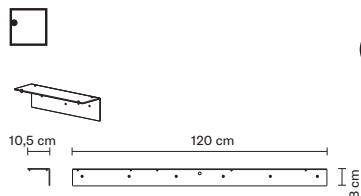

NEW!

D95 Z05
63 Painted gray

price €
117,00 €

0,020 m³
2,50 Kg

Accessorio parete per L1/2 GU10 - L1/2 LED bar - L1/2 LED strip / wall accessory for L1/2 GU10 - L1/2 LED bar - L1/2 LED strip

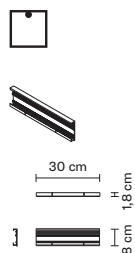

NEW!

D95 M32
63 Painted gray

price €
33,00 €

0,010 m³
0,80 Kg

NEW!

D95 M32
74 Golden aluminium

price €
39,00 €

0,010 m³
0,80 Kg

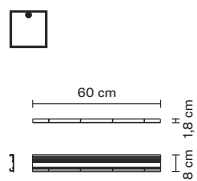

NEW!

D95 M33
63 Painted gray

price €
57,00 €

0,015 m³
1,20 Kg

NEW!

D95 M33
74 Golden aluminium

price €
66,00 €

0,015 m³
1,20 Kg

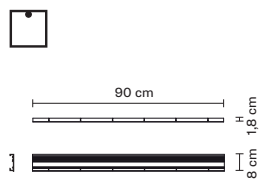

NEW!

D95 M34
63 Painted gray

price €
86,00 €

0,020 m³
1,80 Kg

NEW!

D95 M34
74 Golden aluminium

price €
99,00 €

0,020 m³
1,80 Kg

TILE D95

Pamio Design

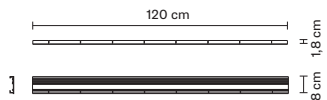

NEW!

D95 M35
63 Painted gray

price €
112,00 €

bulb code
(not incl.)

bulb price €

electrification

technical info /
accessories incl.

0,020 m³
2,40 Kg

NEW!

D95 M35
74 Golden
aluminium

price €
129,00 €

0,020 m³
2,40 Kg

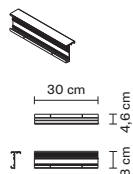

NEW!

D95 M42
63 Painted gray

price €
37,00 €

Strip LED non incl. p. 158. Alim. non incl. p. 200-201 / Strip LED not incl. p. 158.
Alim. not incl. p. 200-201

0,010 m³
0,80 Kg

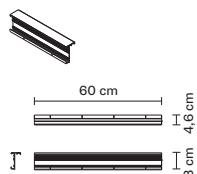

NEW!

D95 M43
63 Painted gray

price €
64,00 €

Strip LED non incl. p. 158. Alim. non incl. p. 200-201 / Strip LED not incl. p. 158.
Alim. not incl. p. 200-201

0,015 m³
1,20 Kg

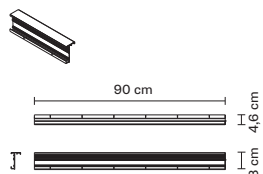

NEW!

D95 M44
63 Painted gray

price €
96,00 €

Strip LED non incl. p. 158. Alim. non incl. p. 200-201 / Strip LED not incl. p. 158.
Alim. not incl. p. 200-201

0,020 m³
1,80 Kg

TILE D95

Pamio Design

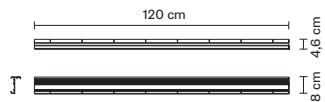

NEW!

D95 M45
63 Painted gray

124,00 €

bulb code
(not incl.)

bulb price €

electrification

technical info /
accessories incl.

0,020 m³
2,40 Kg

Strip LED non incl. p. 158. Alim. non incl. p. 200-201 / Strip LED not incl. p. 158.
Alim. not incl. p. 200-201

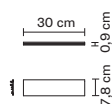

NEW!

D95 Z10
27 Anodize

24,00 €

0,010 m³
0,70 Kg

NEW!

D95 Z10
74 Golden
aluminium

28,00 €

0,010 m³
0,70 Kg

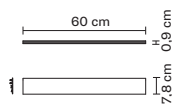

NEW!

D95 Z11
27 Anodize

44,00 €

0,015 m³
0,90 Kg

NEW!

D95 Z11
74 Golden
aluminium

51,00 €

0,015 m³
0,90 Kg

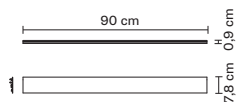

NEW!

D95 Z12
27 Anodize

64,00 €

0,020 m³
1,30 Kg

NEW!

D95 Z12
74 Golden
aluminium

74,00 €

0,020 m³
1,30 Kg

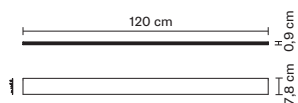

NEW!

D95 Z13
27 Anodize

84,00 €

0,020 m³
1,80 Kg

NEW!

D95 Z13
74 Golden
aluminium

96,00 €

0,020 m³
1,80 Kg

TILE D95

Pamio Design

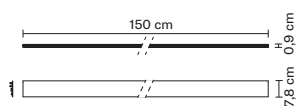

NEW!

D95 Z14 103,00 €
27 Anodize

0,025 m³
2,10 Kg

NEW!

D95 Z14 119,00 €
74 Golden aluminium

0,025 m³
2,10 Kg

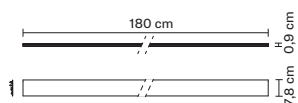

NEW!

D95 Z15 121,00 €
27 Anodize

0,025 m³
2,50 Kg

NEW!

D95 Z15 140,00 €
74 Golden aluminium

0,025 m³
2,50 Kg

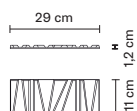

NEW!

D95 E01 C4V 4x57,00 €
00 Transparent

0,008 m³
3,80 Kg

9 ferma vetro per ogni confezione. Altri colori su richiesta (+20%) / 9 glass fastener for each package. Other colours by request (+20%)

NEW!

D95 E01 C4V 4x66,00 €
05 Aquamarine
40 Amethyst
43 Green
47 Amber

0,008 m³
3,80 Kg

9 ferma vetro per ogni confezione. Altri colori su richiesta (+20%) / 9 glass fastener for each package. Other colours by request (+20%)

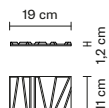

NEW!

D95 E02 C4V 4x64,00 €
00 Transparent

0,005 m³
2,60 Kg

9 ferma vetro per ogni confezione. Altri colori su richiesta (+20%) / 9 glass fastener for each package. Other colours by request (+20%)

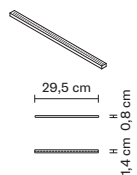

NEW!

A50502 48,00 €



Barra LED / LED bar

LED 24 Vdc 5W
WHITE 2700K Cri 80

0,005 m³
0,80 Kg

TILE D95

Pamio Design



NEW!

code

A50503

price €

39,00 €

bulb code
(not incl.)



LED

bulb price €

electrification

LED 24 Vdc 28,8W
WHITE 3000K Cri>80

technical info /
accessories incl.

0,003 m³
0,35 Kg

Strip LED Prezzo al metro. Al momento dell'ordine comunicare all'azienda le misure del progetto. Alim. non incl. pag. 200-201 / LED strip. Price by meter. When ordering, communicate to the company the dimensions of the project



NEW!

A50601

5,45 €

0,002 m³
0,65 Kg

Lente LED. Prezzo al metro. Al momento dell'ordine comunicare all'azienda le misure del progetto. Alim. non incl. pag. 200-201 / LED lens. Price by meter. When ordering, communicate to the company the dimensions of the project

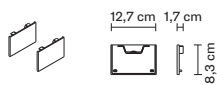

NEW!

D95 Z20
12 Gold

46,00 €

0,003 m³
0,60 Kg

2 tappi per ogni confezione / 2 caps for each package

NEW!

D95 Z20
15 Chrome

40,00 €

0,003 m³
0,60 Kg

2 tappi per ogni confezione / 2 caps for each package

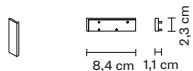

NEW!

D95 Z21
12 Gold

23,00 €

0,001 m³
0,03 Kg

Tappo destro / Right cap

NEW!

D95 Z21
15 Chrome

20,00 €

0,001 m³
0,03 Kg

Tappo destro / Right cap

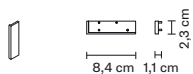

NEW!

D95 Z22
12 Gold

23,00 €

0,001 m³
0,03 Kg

Tappo sinistro / Left cap

NEW!

D95 Z22
12 Gold

20,00 €

0,001 m³
0,03 Kg

Tappo sinistro / Left cap



NEW!

A70401







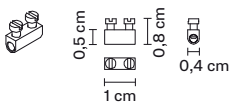
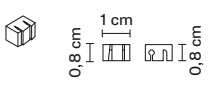
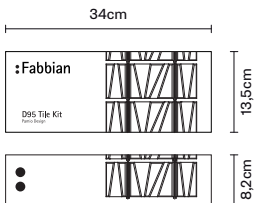
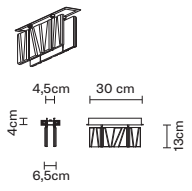

21,00 €

0,001 m³
0,02 Kg

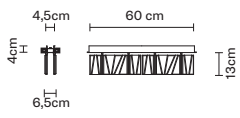
Cavo di sostegno. Prezzo al metro / Support cable. Price by meter

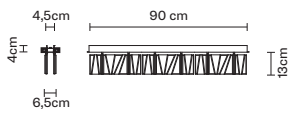
TILE D95

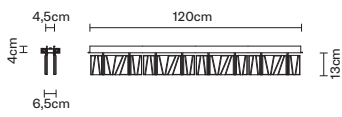
Pamio Design

	code	price €	bulb code (not incl.)	bulb price €	electrification	technical info / accessories incl.
	NEW! A70402	8x0,97 €				0,001 m ³ 0,02 Kg
Ferma cavo di sicurezza / Cable fastener						
	NEW! A70407	9x1,27 €				0,001 m ³ 0,02 Kg
Ferma vetro / Glass fastener						
	NEW! D95 Z01	136,00 €				0,003 m ³ 1,65 Kg
Kit Tile						
	NEW! D95 F01 00 Transparent	325,00 €			LED 700 mA 8,4W WHITE 2700K Cri 80	0,018 m ³ 3,00 Kg IP40
LED 700 mA 8,4W WHITE 2700K Cri 80						
	NEW! D95 F03 00 Transparent	545,00 €			LED 700 mA 16,8W WHITE 2700K Cri 80	0,023 m ³ 6,00 Kg IP40
LED 700 mA 16,8W WHITE 2700K Cri 80						
	NEW! D95 F05 00 Transparent	751,00 €			LED 700 mA 25,2W WHITE 2700K Cri 80	0,036 m ³ 9,00 Kg IP40
LED 700 mA 25,2W WHITE 2700K Cri 80						
	NEW! D95 F07 00 Transparent	947,00 €			LED 700 mA 33,6W WHITE 2700K Cri 80	0,040 m ³ 12,00 Kg IP40
LED 700 mA 33,6W WHITE 2700K Cri 80						

TILE

Sorgente: GU10 / Light source: GU10

Configurazione: 1 o 2 pareti / Layout: 1 or 2 crystal walls

1. Scelta barra e angoli / Metal bar and angle option

1a. Barre lineari / Linear bars

Lunghezza minima 30 cm
Modularità ogni 30 cm
Elettrificazione ogni 30 cm
(2x50W GU10).

Su richiesta sono disponibili elettrificazioni diverse.

Ogni sistema deve prevedere l'utilizzo di un modulo da 30 cm di partenza.

I moduli starter sono moduli cablati per l'alimentazione di partenza.

Minimum length: 30 cm

30 cm modularity

Electrification every 30 cm (2x50W GU10)

Different electrification are available on request.

Each system has to use a 30 cm starter module.

The starter modules are electrified.

D95M11 63 30 cm (Starter)

D95M12 63 30 cm (Normal)

D95M13 63 60 cm (Normal)

D95M14 63 90 cm (Normal)

D95M15 63 120 cm (Normal)

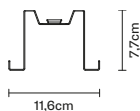
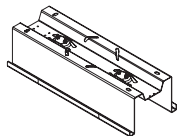

1b. Coppia di tappi / Couple of caps

alluminio dorato
golden aluminium

D95Z20 12

alluminio brillantato
polished aluminium

D95Z20 15

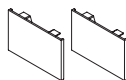

1d. Barra ad angolo / Angle bar

D95M16 63 30x30 cm (Starter)

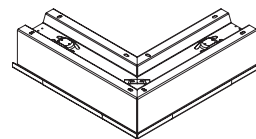

1c. Kit parete / Wall kit

Lunghezza minima 30 cm

Modularità ogni 30 cm

Per la versione a parete vanno aggiunte alle barre lineari indicate qui a lato (F34M1...) uno dei seguenti kit in base alla lunghezza desiderata.

Minimum length: 30 cm

30 cm modularity

For the wall version, it must be added to the linear bars indicated at right (F34M1...) one of the following kits according to the dsired length.

D95Z02 63 30 cm

D95Z03 63 60 cm

D95Z04 63 90 cm

D95Z05 63 120 cm

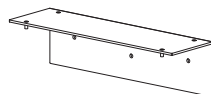

1e. Barra quadrata / Square bar

D95M17 63 30x30 cm (Starter)

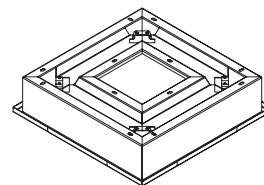

2. Scelta fasce di rivestimento / Cover options

alluminio brillantato
polished aluminium

D95Z10 27 30 cm
D95Z11 27 60 cm
D95Z12 27 90 cm
D95Z13 27 120 cm
D95Z14 27 150 cm
D95Z15 27 180 cm

alluminio dorato
golden aluminium

D95Z10 74 30 cm
D95Z11 74 60 cm
D95Z12 74 90 cm
D95Z13 74 120 cm
D95Z14 74 150 cm
D95Z15 74 180 cm

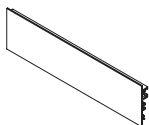

3. Scelta vetri* / Glass options*



D95E01C4V 00
29x11 cm



D95E01C4V 05
29x11 cm



D95E01C4V 40
29x11 cm



D95E01C4V 43
29x11 cm



D95E01C4V 47
29x11 cm



D95E02C4V 00
19x11 cm

* Su richiesta altre colorazioni (visualizzabili sul sito e/o sul Catalogo Generale).

* Other colours (that you can browse on the website or on the General Catalogue) by request.

4. Cavi di sostegno / Support cable

I cavi di sostegno (A70401) verranno consegnati in base alla disposizione compositiva, della quale devono essere indicate il numero di vetri e il numero degli spazi vuoti interni alla composizione.

The support cables (A70401) delivery is based on the building option preferred, of which the number of glasses and interior empty spaces has to be specified.

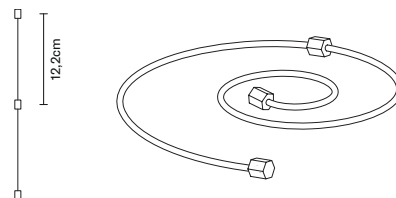

5. Ferma cavi di sicurezza / Security cable fastener

Nel caso in cui si raggiunga un'altezza superiore a 200 cm dovrà essere ordinato necessariamente il ferma cavo di sicurezza (A70402C08), nella misura di 1 per ogni cavo d'acciaio.

In case the composition length were higher than cm 200 one security cable fastener (A70402C08) for each stainless steel cable has to be ordered.



TILE

Sorgente: LED BAR / Light source: LED BAR

Configurazione: 1 o 2 pareti / Layout: 1 or 2 crystal walls

1. Scelta barra e angoli / Metal bar and angle option

1a. Barre lineari / Linear bars

Lunghezza minima 30 cm
Modularità ogni 30 cm
Ogni barra è compresa di 4 ferma cavo di sicurezza.
Ogni alimentatore è dimmerabile e supporta max 12 barre LED.

*Minimum length: 30 cm
30 cm modularity.
4 security cable fasteners are included in each bar.
Each driver is dimmable and supports max 12 LED bar.*

D95M01 63 30 cm
(Starter, Alim. non incluso - Alim. not included)

D95M02 63 30 cm
(Starter, 1 Alim. dim. incluso - 1 Alim. dim. included)

D95M03 63 30 cm
(Starter, 2 Alim. dim. incluso - 2 Alim. dim. included)

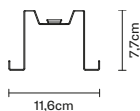
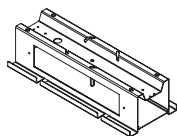

1b. Coppia di tappi / Couple of caps

alluminio dorato
golden aluminium

D95Z20 12

alluminio brillantato
polished aluminium

D95Z20 15

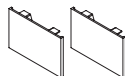

1c. Kit parete / Wall kit

Lunghezza minima 30 cm
Modularità ogni 30 cm
Per la versione a parete vanno aggiunte alle barre lineari indicate a lato (F34MO...) il seguente kit in base alla lunghezza desiderata.

*Minimum length: 30 cm
30 cm modularity.
For the wall version, it must be added to the linear bars indicated at right (F34MO...) the following kit according to the desired length.*

D95Z02 63 30 cm

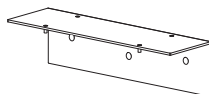

1d. Barra ad angolo / Angle bar

Ogni alimentatore è dimmerabile e supporta max 12 barre LED.
Each driver is dimmable and supports max 12 LED bar.

D95M06 63 30x30 cm
(Starter, 2 Alim. dim. inclusi - 2 Alim. dim. included)

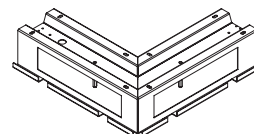

1e. Barra quadrata / Square bar

Ogni alimentatore è dimmerabile e supporta max 12 barre LED.
Each driver is dimmable and supports max 12 LED bar.

D95M07 63 30x30 cm
(Starter, 4 Alim. dim. inclusi - 4 Alim. dim. included)

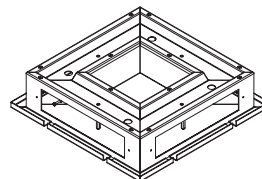

2. Scelta fasce di rivestimento / Cover options

alluminio brillantato
polished aluminium

D95Z10 27 30 cm
D95Z11 27 60 cm
D95Z12 27 90 cm
D95Z13 27 120 cm
D95Z14 27 150 cm
D95Z15 27 180 cm

alluminio dorato
golden aluminium

D95Z10 74 30 cm
D95Z11 74 60 cm
D95Z12 74 90 cm
D95Z13 74 120 cm
D95Z14 74 150 cm
D95Z15 74 180 cm



3. Scelta vetri* / Glass options*



D95E01C4V 00
29x11 cm



D95E01C4V 05
29x11 cm



D95E01C4V 40
29x11 cm



D95E01C4V 43
29x11 cm



D95E01C4V 47
29x11 cm



D95E02C4V 00
19x11 cm

* Su richiesta altre colorazioni (visualizzabili sul sito e/o sul Catalogo Generale).

* Other colours (that you can browse on the website or on the General Catalogue) by request.

4. Cavi di sostegno / Support cable

I cavi di sostegno (A70401) verranno consegnati in base alla disposizione compositiva, della quale devono essere indicate il numero di vetri e il numero degli spazi vuoti interni alla composizione.

The support cables (A70401) delivery is based on the building option preferred, of which the number of glasses and interior empty spaces has to be specified.

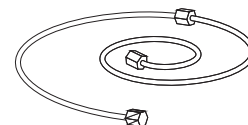
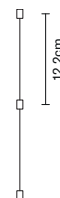

5. Sorgente luminosa a LED / LED light source

A50502C01 5W 24Vdc 2700K 400lm CRI 80

Ogni alimentatore è dimmerabile 1..10V e supporta max 12 barre led. Altri tipi di dimmerazione su richiesta.

Each driver is dimmable 1..10V and supports max 12 led bar. Other kind of dimming by request.

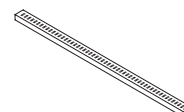

TILE

Sorgente: LED STRIP / Light source: LED STRIP

Configurazione: 1 o 2 pareti / Layout: 1 or 2 crystal walls

1. Scelta barra e angoli / Metal bar and angle option

1a. Barre lineari / Linear bars

Lunghezza minima 30 cm
Modularità ogni 30 cm
LED e driver non inclusi

*Minimum length: 30 cm
30 cm modularity
LED and driver not included*

D95M22 63 30 cm
D95M23 63 60 cm
D95M24 63 90 cm
D95M25 63 120 cm

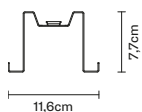
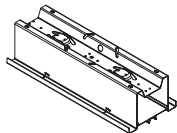

1b. Coppia di tappi / Couple of caps

alluminio dorato
golden aluminium
D95Z20 12

alluminio brillantato
polished aluminium
D95Z20 15

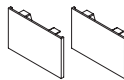

1d. Barra ad angolo / Angle bar

D95M26 63 30x30 cm (Starter)

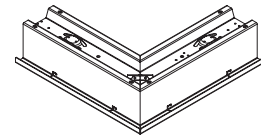

1c. Kit parete / Wall kit

Lunghezza minima 30 cm
Modularità ogni 30 cm
Per la versione a parete vanno aggiunte alle barre lineari indicate qui a lato (F34M2...) uno dei seguenti kit in base alla lunghezza desiderata.

*Minimum length: 30 cm
30 cm modularity
For the wall version, it must be added to the linear bars indicated at right (F34M2...) one of the following kits according to the dsired length.*

D95Z02 63 30 cm
D95Z03 63 60 cm
D95Z04 63 90 cm
D95Z05 63 120 cm

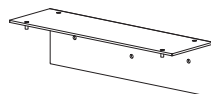

1e. Barra quadrata / Square bar

D95M27 63 30x30 cm

LED e driver non inclusi
LED and driver not included

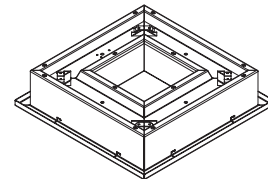

2. Scelta fasce di rivestimento / Cover options

alluminio brillantato
polished aluminium

D95Z10 27 30 cm
D95Z11 27 60 cm
D95Z12 27 90 cm
D95Z13 27 120 cm
D95Z14 27 150 cm
D95Z15 27 180 cm

alluminio dorato
golden aluminium

D95Z10 74 30 cm
D95Z11 74 60 cm
D95Z12 74 90 cm
D95Z13 74 120 cm
D95Z14 74 150 cm
D95Z15 74 180 cm



3. Scelta vetri* / Glass options*

 D95E01C4V 00
29x11 cm

 D95E01C4V 05
29x11 cm

 D95E01C4V 40
29x11 cm

 D95E01C4V 43
29x11 cm

 D95E01C4V 47
29x11 cm

 D95E02C4V 00
19x11 cm

* Su richiesta altre colorazioni (visualizzabili sul sito e/o sul Catalogo Generale).

* Other colours (that you can browse on the website or on the General Catalogue) by request.

4. Cavi di sostegno / Support cable

I cavi di sostegno (A70401) verranno consegnati in base alla disposizione compositiva, della quale devono essere indicate il numero di vetri e il numero degli spazi vuoti interni alla composizione.

The support cables (A70401) delivery is based on the building option preferred, of which the number of glasses and interior empty spaces has to be specified.

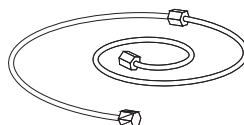
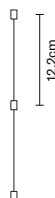

5. Ferma cavi di sicurezza / Security cable fastener

Nel caso in cui si raggiunga un'altezza superiore a 200 cm dovrà essere ordinato necessariamente il ferma cavo di sicurezza (A70402C08), nella misura di 1 per ogni cavo d'acciaio.

In case the composition length were higher than cm 200 one security cable fastener (A70402C08) for each stainless steel cable has to be ordered.



6. Sorgente luminosa a LED e lente / LED and lens light source

A50503 LED Strip 24Vdc 3000K Cri 80
28,8W 2600 lm al metro / by meter
A50601 LED Lens 30°

Vendute al metro.
Specificare le lunghezze delle singole tratte lineari.

*Sold by meter.
Specify the lengths of the single linear section.*

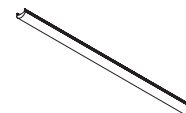
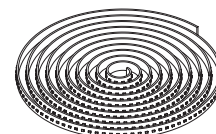

TILE

Senza Sorgente / No Light source

Configurazione: 1 parete / Layout: 1 crystal wall

1. Scelta barra e angoli / Metal bar and angle option

1a. Barre lineari / Linear bars

Lunghezza minima 30 cm
Modularità ogni 30 cm

*Minimum length: 30 cm
30 cm modularity*

alluminio brillantato
polished aluminium

D95M32 63 30 cm
D95M33 63 60 cm
D95M34 63 90 cm
D95M35 63 120 cm

alluminio dorato
golden aluminium

D95M32 74 30 cm
D95M33 74 60 cm
D95M34 74 90 cm
D95M35 74 120 cm

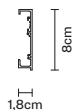
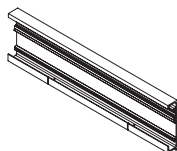

1b. Tappi / Caps

alluminio brillantato
polished aluminium

D95Z21 15 Tappo destro / Right Cap
D95Z22 15 Tappo sinistro / Left Cap

alluminio dorato
golden aluminium

D95Z21 12 Tappo destro / Right Cap
D95Z22 12 Tappo sinistro / Left Cap



2. Scelta fasce di rivestimento / Cover options

alluminio brillantato
polished aluminium

D95Z10 27 30 cm
D95Z11 27 60 cm
D95Z12 27 90 cm
D95Z13 27 120 cm
D95Z14 27 150 cm
D95Z15 27 180 cm

alluminio dorato
golden aluminium

D95Z10 74 30 cm
D95Z11 74 60 cm
D95Z12 74 90 cm
D95Z13 74 120 cm
D95Z14 74 150 cm
D95Z15 74 180 cm

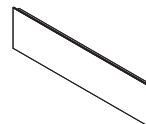

3. Scelta vetri* / Glass options*



D95E01C4V 00
29x11 cm



D95E01C4V 05
29x11 cm



D95E01C4V 40
29x11 cm



D95E01C4V 43
29x11 cm



D95E01C4V 47
29x11 cm



D95E02C4V 00
19x11 cm

* Su richiesta altre colorazioni (visualizzabili sul sito e/o sul Catalogo Generale).

* Other colours (that you can browse on the website or on the General Catalogue) by request.

4. Cavi di sostegno / Support cable

I cavi di sostegno (A70401) verranno consegnati in base alla disposizione compositiva, della quale devono essere indicate il numero di vetri e il numero degli spazi vuoti interni alla composizione.

The support cables (A70401) delivery is based on the building option preferred, of which the number of glasses and interior empty spaces has to be specified.

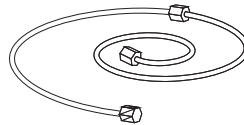
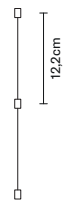

5. Ferma cavi di sicurezza / Security cable fastener

Nel caso in cui si raggiunga un'altezza superiore a 200 cm dovrà essere ordinato necessariamente il ferma cavo di sicurezza (A70402C08), nella misura di 1 per ogni cavo d'acciaio.

In case the composition length were higher than cm 200 one security cable fastener (A70402C08) for each stainless steel cable has to be ordered.



TILE

Sorgente: LED STRIP / *Light source: LED STRIP*
Configurazione: 1 parete / *Layout: 1 crystal wall*

1. Scelta barra e angoli / *Metal bar and angle option*

1a. Barre lineari / *Linear bars*

Lunghezza minima 30 cm
Modularità ogni 30 cm
LED e driver non inclusi

*Minimum length: 30 cm
30 cm modularity
LED and driver not included*

D95M42 63 30 cm
D95M43 63 60 cm
D95M44 63 90 cm
D95M45 63 120 cm

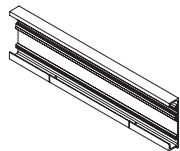

1b. Tappi / *Caps*

alluminio brillantato
polished aluminium

D95Z21 15 Tappo destro / *Right Cap*
D95Z22 15 Tappo sinistro / *Left Cap*

alluminio dorato
golden aluminium

D95Z21 12 Tappo destro / *Right Cap*
D95Z22 12 Tappo sinistro / *Left Cap*



2. Scelta fasce di rivestimento / *Cover options*

alluminio brillantato
polished aluminium

D95Z10 27 30 cm
D95Z11 27 60 cm
D95Z12 27 90 cm
D95Z13 27 120 cm
D95Z14 27 150 cm
D95Z15 27 180 cm

alluminio dorato
golden aluminium

D95Z10 74 30 cm
D95Z11 74 60 cm
D95Z12 74 90 cm
D95Z13 74 120 cm
D95Z14 74 150 cm
D95Z15 74 180 cm

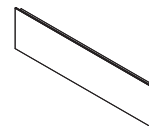

3. Scelta vetri* / Glass options*



D95E01C4V 00
29x11 cm



D95E01C4V 05
29x11 cm



D95E01C4V 40
29x11 cm



D95E01C4V 43
29x11 cm



D95E01C4V 47
29x11 cm



D95E02C4V 00
19x11 cm

* Su richiesta altre colorazioni (visualizzabili sul sito e/o sul Catalogo Generale).

* Other colours (that you can browse on the website or on the General Catalogue) by request.

4. Cavi di sostegno / Support cable

I cavi di sostegno (A70401) verranno consegnati in base alla disposizione compositiva, della quale devono essere indicate il numero di vetri e il numero degli spazi vuoti interni alla composizione.

The support cables (A70401) delivery is based on the building option preferred, of which the number of glasses and interior empty spaces has to be specified.

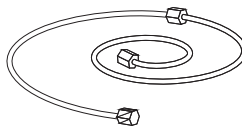
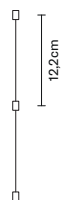

5. Ferma cavi di sicurezza / Security cable fastener

Nel caso in cui si raggiunga un'altezza superiore a 200 cm dovrà essere ordinato necessariamente il ferma cavo di sicurezza (A70402C08), nella misura di 1 per ogni cavo d'acciaio.

In case the composition length were higher than cm 200 one security cable fastener (A70402C08) for each stainless steel cable has to be ordered.



6. Sorgente luminosa a LED e lente / LED and lens light source

A50503 LED Strip 24Vdc 3000K Cri 80
28,8W 2600 lm al metro / *by meter*
A50601 LED Lens 30°

Vendute al metro.
Specificare le lunghezze delle singole tratte lineari.

Sold by meter.
Specify the lengths of the single linear section.

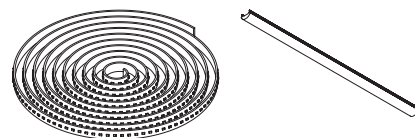

MONTAGGIO
/ ASSEMBLING

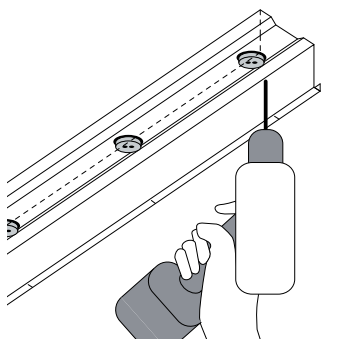

Collegamento elettrico
e fissaggio della barra
*Electrical connection
and bar fastening*

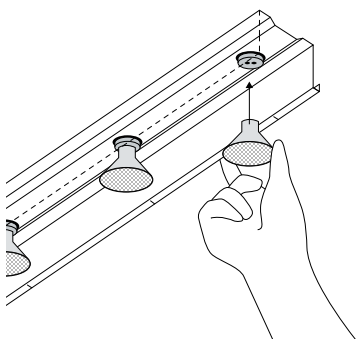

Inserimento delle lampadine
Light bulbs installation

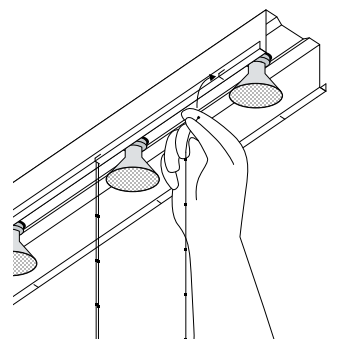

Inserimento dei cavi
e loro taglio a misura
*Stainless steel cables
insertion and cut*

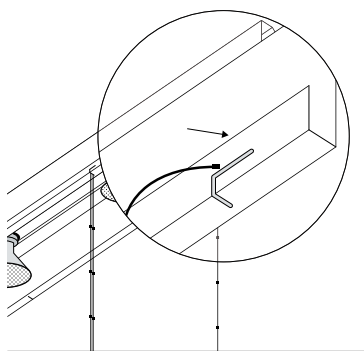

Dettaglio dell'inserimento
del cavo
Cable insertion detail

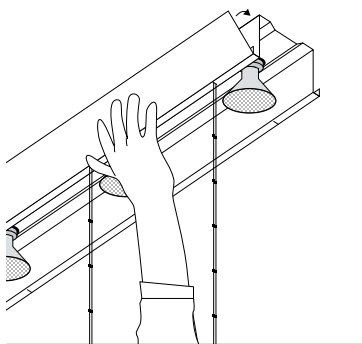

Posizionamento
della fascia di rivestimento
Cover assembly

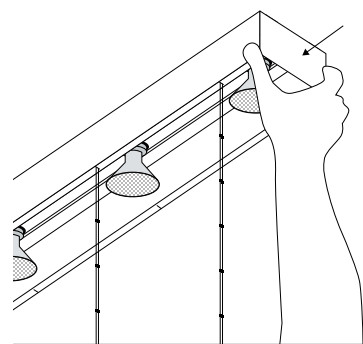

Inserimento
dei tappi di chiusura
Locking caps assembly

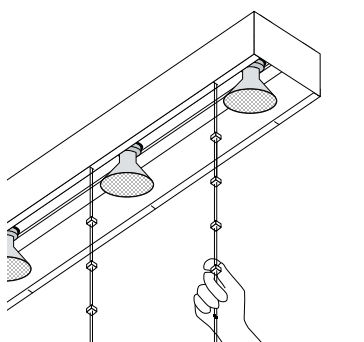

Montaggio dei ferma vetro
Glass fastener assembly

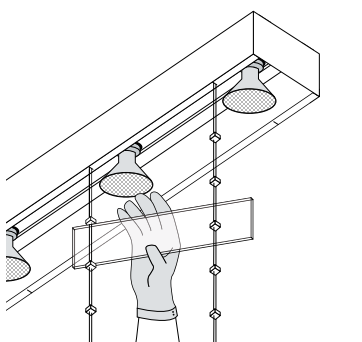

Inserimento degli elementi
in vetro cristallino
Glass tiles insertion

TOOLS F19

FE Design

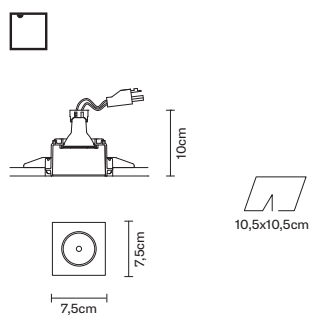

code

price €

bulb code (not incl.)

bulb price €

electrification

technical info / accessories incl.

F19 F01
01 White

14,19 €

A11102C20

20x4,69 €

GU10 1x50W
HAGS

0,004 m³
0,27 Kg
IP20

A11105C01

1x52,72 €

GU10 1x5,5W



Fisso/cassaforma+Blocco luce / Fixed/wallbox+Spot light

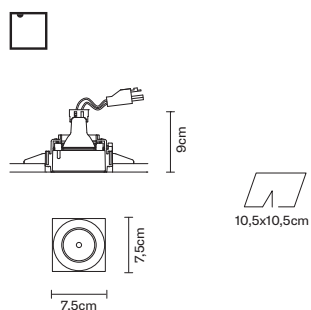

F19 F04
01 White

145,00 €

A11102C20

20x4,69 €

GU10 1x50W
HAGS

0,008 m³
0,45 Kg
IP44

A11105C01

1x52,72 €

GU10 1x5,5W



Fisso/cassaforma+Blocco luce / Fixed/wallbox+Spot light

F19 L06
01 White

109,00 €

Blocco luce / Spot light

F19 Z01
01 White

36,00 €

Cassaforma / Wallbox

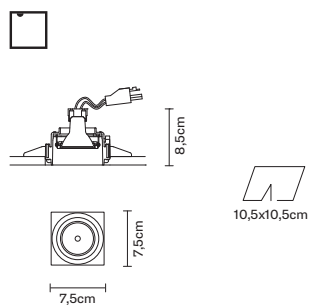

F19 F10
01 White

98,00 €

A11102C20

20x4,69 €

GU10 1x50W
HAGS

0,004 m³
0,27 Kg
IP20

A11105C01

1x52,72 €

GU10 1x5,5W



Orientabile/cassaforma+Blocco luce / Adjustable/wallbox+Spot light

F19 L02
01 White

62,00 €

Blocco luce / Spot light

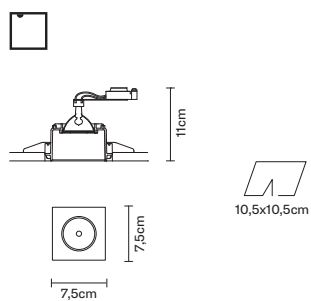

F19 F02
01 White

31,40 €

A10704C10

10x5,67 €

GU5,3 1x50W
HRGS

0,004 m³
0,29 Kg
IP20

A10705C01

1x47,65 €

GU5,3 1x4W



Fisso/cassaforma+Blocco luce. Accessori p. 200-201 / Fixed/wallbox+Spot light. Accessories p. 200-201

TOOLS F19

FE Design

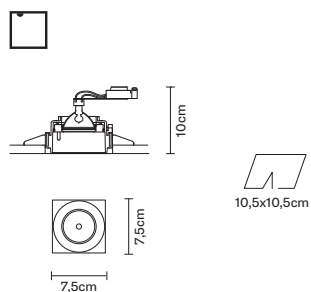

code

price €

bulb code (not incl.)

bulb price €

electrification

technical info / accessories incl.

F19 F05
01 White

145,00 €

A10704C10

10x5,67 €

GU5,3 1x50W
HRGS

0,008 m³
0,47 Kg
IP44

A10705C01

1x47,65 €

GU5,3 1x4W

Fixo/cassaforma+ Blocco luce. Accessori p. 200-201 / Fixed/wallbox+ Spot light. Accessories p. 200-201

F19 L07
01 White

109,00 €

Blocco luce. Accessori p. 200-201 / Spot light. Accessories p. 200-201

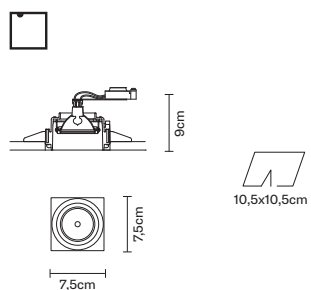

F19 F11
01 White

94,00 €

A10704C10

10x5,67 €

GU5,3 1x50W
HRGS

0,008 m³
0,42 Kg
IP20

A10705C01

1x47,65 €

GU5,3 1x4W

Orientabile/cassaforma+ Blocco luce. Accessori p. 200-201 / Adjustable/wallbox+ Spot light. Accessories p. 200-201

F19 L04
01 White

58,00 €

Blocco luce. Accessori p. 200-201 / Spot light. Accessories p. 200-201

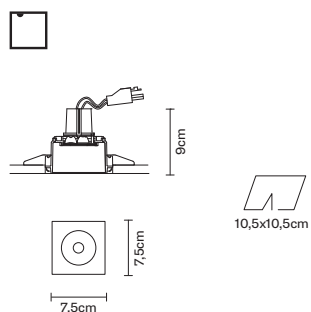

F19 F03
01 White

95,00 €

LED 700mA 10W-40°
WHITE 3000K Cri 80
0,004 m³
0,33 Kg
IP20

Fixo/cassaforma+ Blocco luce. Accessori p. 200-201 / Fixed/wallbox+ Spot light. Accessories p. 200-201

F19 F06
01 White

196,00 €

LED 700mA 10W-40°
WHITE 3000K Cri 80
0,008 m³
0,51 Kg
IP44

Fixo/cassaforma+ Blocco luce. Accessori p. 200-201 / Fixed/wallbox+ Spot light. Accessories p. 200-201

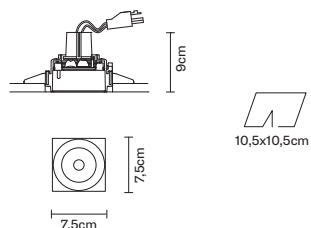

F19 L08
01 White

160,00 €

Blocco luce. Accessori p. 200-201 / Spot light. Accessories p. 200-201

TOOLS F19

FE Design

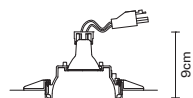

code

price €

bulb code
(not incl.)

bulb price €

electrification

technical info /
accessories incl.

F19 F20
01 White

14,19 €

A11102C20

20x4,69 €

GU10 1x50W

0,004 m³



HAGS

0,25 Kg

IP20

A11105C01

1x52,72 €

GU10 1x5,5W



Fisso/cassaforma+ Blocco luce / Fixed/wallbox+ Spot light

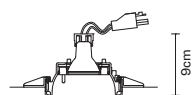

F19 F23
01 White

143,00 €

A11102C20

20x4,69 €

GU10 1x50W

0,008 m³



HAGS

0,44 Kg

IP44

A11105C01

1x52,72 €

GU10 1x5,5W



Fisso/cassaforma+ Blocco luce / Fixed/wallbox+ Spot light

F19 Z02
01 White

34,00 €

Cassaforma / Wallbox

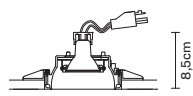

F19 F30
01 White

96,00 €

A11102C20

20x4,69 €

GU10 1x50W

0,008 m³



HAGS

0,38 Kg

IP20

A11105C01

1x52,72 €

GU10 1x5,5W



Orientabile/cassaforma+ Blocco luce / Adjustable/wallbox+ Spot light

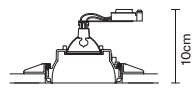

F19 F21
01 White

31,40 €

A10704C10

10x5,67 €

GU5,3 1x50W

0,004 m³



HRGS

0,27 Kg

IP20

A10705C01

1x47,65 €

GU5,3 1x4W



Fisso/cassaforma+ Blocco luce. Accessori p. 200-201 / Fixed/wallbox+ Spot light.
Accessories p. 200-201

TOOLS F19

FE Design

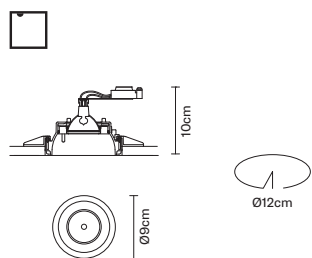

code

price €

bulb code
(not incl.)

bulb price €

electrification

technical info /
accessories incl.

F19 F24
01 White

143,00 €

A10704C10

10x5,67 €

GU5,3 1x50W
HRGS

0,008 m³
0,40 Kg
IP44

A10705C01

1x47,65 €

GU5,3 1x4W

Fisso/cassaforma+Blocco luce. Accessori p. 200-201 / Fixed/wallbox+Spot light.
Accessories p. 200-201

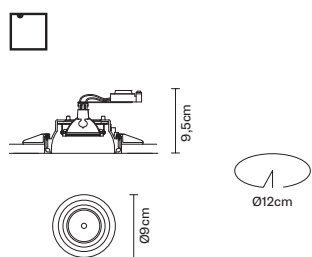

F19 F31
01 White

92,00 €

A10704C10

10x5,67 €

GU5,3 1x50W
HRGS

0,008 m³
0,42 Kg
IP20

A10705C01

1x47,65 €

GU5,3 1x4W

Orientabile/cassaforma+Blocco luce. Accessori p. 200-201 / Adjustable/
wallbox+Spot light. Accessories p. 200-201

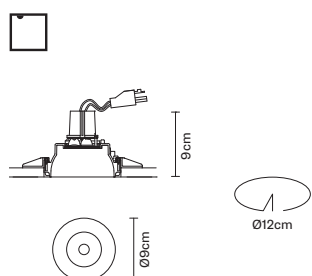

F19 F22
01 White

95,00 €

LED

LED 700mA 10W-40°
WHITE 3000K Cri 80
0,004 m³
0,31 Kg
IP20

Fisso/cassaforma+Blocco luce. Accessori p. 200-201 / Fixed/wallbox+Spot light.
Accessories p. 200-201

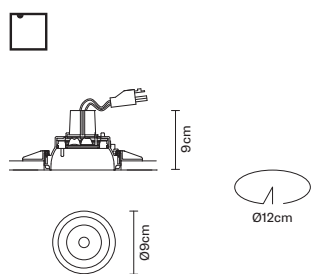

F19 F25
01 White

194,00 €

LED



LED 700mA 10W-40°
WHITE 3000K Cri 80
0,008 m³
0,50 Kg
IP44

Fisso/cassaforma+Blocco luce. Accessori p. 200-201 / Fixed/wallbox+Spot light.
Accessories p. 200-201

TOOLS F19

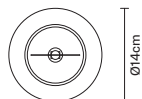
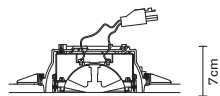
FE Design



code	price €	bulb code (not incl.)	bulb price €	electrification	technical info / accessories incl.
F19 F50 01 White	103,00 €	A10602C06 	6x13,28 €	G53 1x100W HMGS	0,012 m ³ 0,51 Kg IP20 
		A10603C01 	1x140,58 €	G53 1x15W WHITE 3000K	
		Orientabile/cassaforma+Blocco luce. Accessori p. 200-201 / Adjustable/ wallbox+Spot light. Accessories p. 200-201			
F19 L11 01 White	62,00 €				Blocco luce. Accessori p. 200-201 / Spot light. Accessories p. 200-201
F19 Z04 01 White	41,00 €				Cassaforma / Wallbox

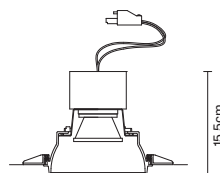

F19 F53 01 White	211,00 €	 		LED 500mA 1x20W- 34° WHITE 3000K Cri 80	0,012 m ³ 0,55 Kg IP20
					Fisso/cassaforma+Blocco luce. Accessori p. 200-201 / Fixed/wallbox+Spot light. Accessories p. 200-201
F19 L18 01 White	171,00 €				Blocco luce. Accessori p. 200-201 / Spot light. Accessories p. 200-201

TOOLS F19

FE Design

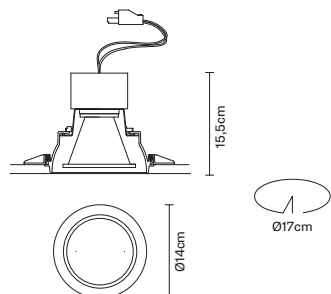

code

price €

bulb code
(not incl.)

bulb price €

electrification

technical info /
accessories incl.

F19 F54
01 White

229,00 €



LED 500mA 1x20W-
22°
WHITE 3000K Cri 80

0,012 m³
0,55 Kg
IP20

Fisso/cassaforma+Blocco luce. Accessori p. 200-201 / Fixed/wallbox+Spot light.
Accessories p. 200-201

F19 L19
01 White

188,00 €

Blocco luce. Accessori p. 200-201 / Spot light. Accessories p. 200-201

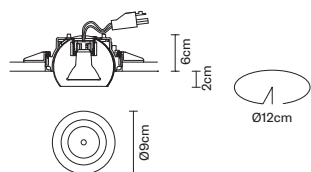

F19 F40
01 White
02 Black

114,00 €



20x10,16 €

GU10 1x50W
HAGS

0,008 m³
0,55 Kg
IP20



1x52,72 €



GU10 1x5,5W



Orientabile/cassaforma+Blocco luce / Adjustable/wallbox+Spot light

F19 L09
01 White
02 Black

80,00 €

Blocco luce / Spot light

F19 Z03
01 White

34,00 €

Cassaforma / Wallbox

F19 F40
15 Chrome
41 Copper

134,00 €



20x10,16 €

GU10 1x50W
HAGS

0,008 m³
0,55 Kg
IP20



1x52,72 €



GU10 1x5,5W



Orientabile/cassaforma+Blocco luce / Adjustable/wallbox+Spot light

F19 L09
15 Chrome
41 Copper

100,00 €

Blocco luce / Spot light

TOOLS F19

FE Design

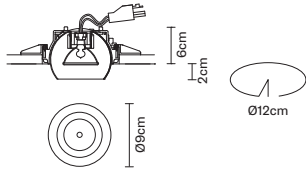

<i>code</i>	<i>price €</i>	<i>bulb code (not incl.)</i>	<i>bulb price €</i>	<i>electrification</i>	<i>technical info / accessories incl.</i>
F19 F41 01 White 02 Black	111,00 €	A10704C10 	10x5,67 €	GU5,3 1x50W HRGS	0,008 m ³ 0,54 Kg IP20
		A10705C01 	1x47,65 €	GU5,3 1x4W	
Orientabile/cassaforma+Blocco luce / Adjustable/wallbox+Spot light					
F19 L10 01 White 02 Black	77,00 €				
Blocco luce / Spot light					
F19 F41 15 Chrome 41 Copper	130,00 €	A10704C10 	10x5,67 €	GU5,3 1x50W HRGS	0,008 m ³ 0,54 Kg IP20
		A10705C01 	1x47,65 €	GU5,3 1x4W	
Orientabile/cassaforma+Blocco luce / Adjustable/wallbox+Spot light					
F19 L10 15 Chrome 41 Copper	96,00 €				
Blocco luce / Spot light					

TOOLS F19

FE Design

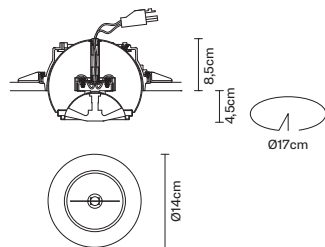

code

price €

**bulb code
(not incl.)**

bulb price €

electrification

**technical info /
accessories incl.**

F19 F60
01 White
02 Black

125,00 €

A10602C06

6x13,28 €

G53 1x100W
HMGS

0,012 m³
0,80 Kg
IP20



A10603C01

1x140,58 €

G53 1x15W
WHITE 3000K



Orientabile/cassaforma+Blocco luce / Adjustable/wallbox+Spot light

F19 L14
01 White
02 Black

84,00 €

Blocco luce / Spot light

F19 Z05
01 White

41,00 €

Cassaforma / Wallbox

F19 F60
15 Chrome
41 Copper

155,00 €

A10602C06

6x13,28 €

G53 1x100W
HMGS

0,012 m³
0,80 Kg
IP20



A10603C01

1x140,58 €

G53 1x15W
WHITE 3000K



Orientabile/cassaforma+Blocco luce / Adjustable/wallbox+Spot light

F19 L14
15 Chrome
41 Copper

114,00 €

Blocco luce / Spot light

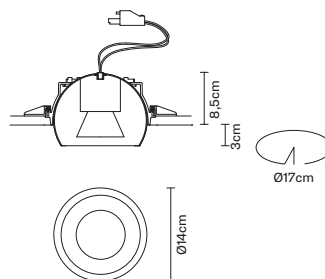

F19 F63
01 White
02 Black

270,00 €



LED 500mA 1x20W-
34°
WHITE 3000K Cri 80

0,012 m³
0,85 Kg
IP20

Orientabile/cassaforma+Blocco luce / Adjustable/wallbox+Spot light

F19 L17
01 White
02 Black

229,00 €

Blocco luce / Spot light

F19 F63
15 Chrome
41 Copper

297,00 €



LED 1x20W-34°
Cri 80

0,012 m³
0,85 Kg
IP20

Orientabile/cassaforma+Blocco luce / Adjustable/wallbox+Spot light

F19 L17
15 Chrome
41 Copper

256,00 €

Blocco luce / Spot light

1.

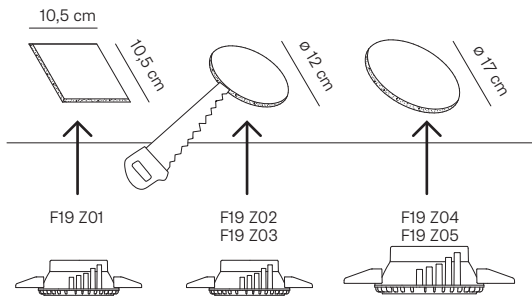

Scegliere la dimensione del foro da fare sul cartongesso in base al tipo di cassaforma.

Determine the size of the hole to be made in the plasterboard, depending on the type of formwork.

2.

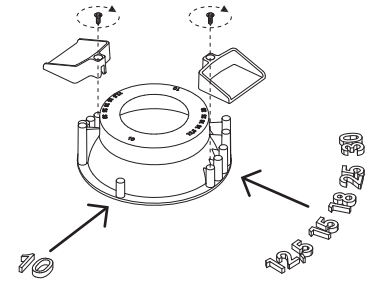

La cassaforma viene fornita già predisposta per lo spessore di 12,5 mm del cartongesso. Per spessori diversi spostare le alette.

The formwork is supplied ready for a plasterboard thickness of 12.5 mm. For other thicknesses, move the tabs.

3.

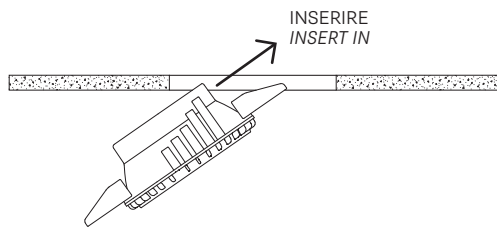

Inserire la cassaforma all'interno del cartongesso e posizionarla in corrispondenza del foro.

Fit the formwork inside the plasterboard and position it over the hole.

4.

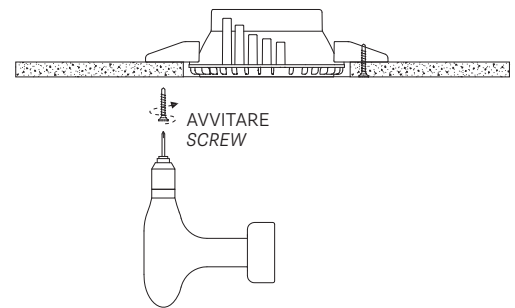

In corrispondenza delle alette, fissare la cassaforma al cartongesso utilizzando le viti incluse nella confezione.

Where the tabs are, fasten the formwork to the plasterboard using the screws provided in the pack.

5.

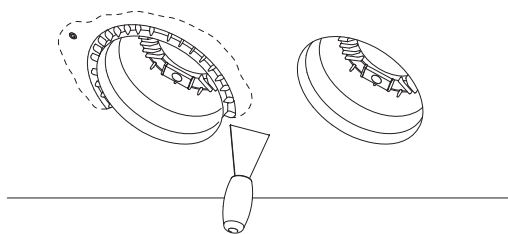

Stuccare perfettamente i bordi della cassaforma in modo da uniformare la finitura del soffitto con l'interno della cassaforma.

Perfectly plaster the edges of the formwork so the ceiling finish is uniform with the inside of the formwork.

6.

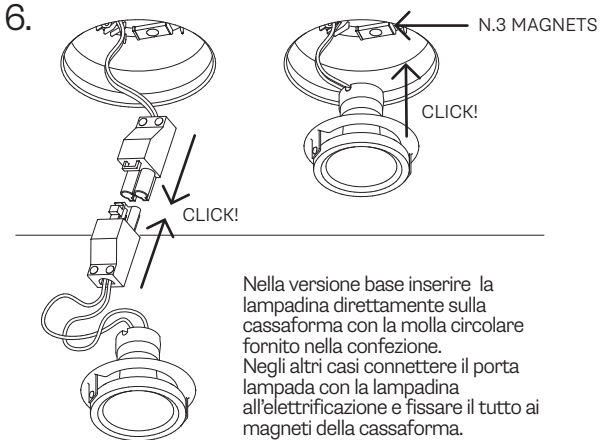

Nella versione base inserire la lampadina direttamente sulla cassaforma con la molla circolare fornito nella confezione. Negli altri casi connettere il porta lampada con la lampadina all'elettrificazione e fissare il tutto ai magneti della cassaforma.

In the basic version, fit the light bulb directly on the formwork using the round spring provided in the pack. In other cases, connect the lamp holder with light bulb to the power supply and fasten the whole to the formwork magnets.

TOROIDALE D71

DesignZagato

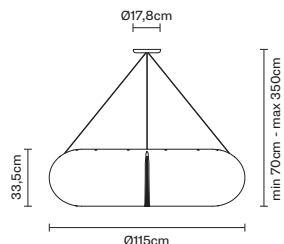

code

price €

bulb code
(not incl.)

bulb price €

electrification

technical info /
accessories incl.

D71 A01
00 Transparent

1.241,00 €

A10217C10

10x18,36 €

E27 12x22W
FBT

0,576 m³
16,85 Kg



TWIRL D49

Francesco Lucchese

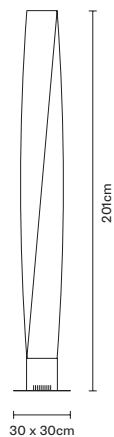

code

price €

bulb code
(not incl.)

bulb price €

electrification

technical info /
accessories incl.

D49 C01
59 Satin
stainless
steel

620,00 €

A10209C12

12x16,80 €

E27 1x205W
HSGST η 67,40%

0,215 m³
11,40 Kg
IP20

Variatore luce p. 201 / Light dimmer p. 201

VENERE D55

Francesco Lucchese

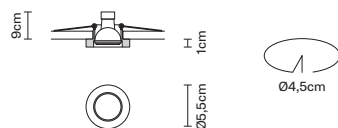

code

price €

bulb code
(not incl.)

bulb price €

electrification

technical info /
accessories incl.

D55 F02
01 White

14,20 €

A10401C10

10x3,71 €

GU4 1x20W
HRGS η 100,00%

0,001 m³
0,20 Kg
IP20

In esaurimento. Accessori p. 200-201 / While stocks last. Accessories p. 200-201

D55 F02
11 Polished
aluminium

15,80 €

A10401C10

10x3,71 €

GU4 1x20W
HRGS η 100,00%

0,001 m³
0,20 Kg
IP20

In esaurimento. Accessori p. 200-201 / While stocks last. Accessories p. 200-201

VENERE D55

Francesco Lucchese

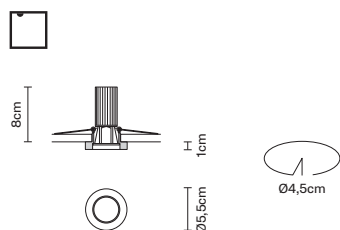

code

price €

bulb code (not incl.)

bulb price €

electrification

technical info / accessories incl.

D55 F35
01 White

85,80 €



LED 700mA 3W-40°
WHITE 3000K Cri 80

0,001 m³
0,20 Kg
IP20

In esaurimento / While stocks last

D55 F35
11 Polished aluminium

87,00 €



LED 700mA 3W-40°
WHITE 3000K Cri 80

0,001 m³
0,20 Kg
IP20

In esaurimento / While stocks last

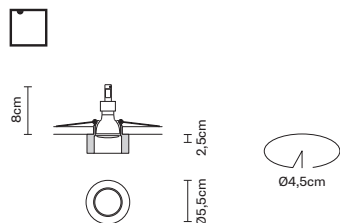

D55 F06
01 White

19,20 €

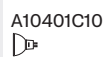

10x3,71 €

GU4 1x20W
HRGS η 63,00%

0,001 m³
0,20 Kg
IP20

In esaurimento. Accessori p. 200-201 / While stocks last. Accessories p. 200-201

D55 F06
11 Polished aluminium

21,50 €

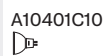

10x3,71 €

GU4 1x20W
HRGS η 63,00%

0,001 m³
0,20 Kg
IP20

In esaurimento. Accessori p. 200-201 / While stocks last. Accessories p. 200-201

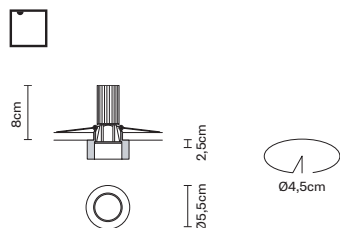

D55 F37
01 White

90,00 €



LED 700mA 3W-40°
WHITE 3000K Cri 80

0,001 m³
0,20 Kg
IP20

In esaurimento / While stocks last

D55 F37
11 Polished aluminium

91,70 €



LED 700mA 3W-40°
WHITE 3000K Cri 80

0,001 m³
0,20 Kg
IP20

In esaurimento / While stocks last

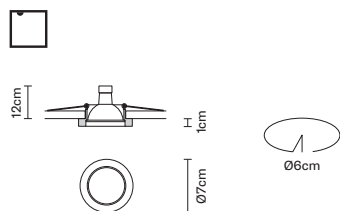

D55 F09
01 White

14,20 €

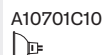

10x2,93 €

GU5,3 1x50W
HRGS η 82,40%

0,001 m³
0,25 Kg
IP20

Accessori p. 200-201 / Accessories p. 200-201

D55 F09
11 Polished aluminium

15,80 €

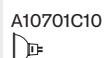

10x2,93 €

GU5,3 1x50W
HRGS η 82,40%

0,001 m³
0,25 Kg
IP20

Accessori p. 200-201 / Accessories p. 200-201

VENERE D55

Francesco Lucchese

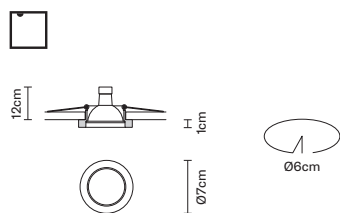

code

price €

**bulb code
(not incl.)**

bulb price €

electrification

**technical info /
accessories incl.**

D55 F10
01 White

14,50 €

A11102C20

20x4,69 €

GU10 1x50W
HAGS η 97,10%

0,001 m³
0,25 Kg
IP20

A11105C01

1x52,72 €

GU10 1x5,5W

D55 F10
11 Polished
aluminium

16,30 €

A11102C20

20x4,69 €

GU10 1x50W
HAGS η 97,10%

0,001 m³
0,25 Kg
IP20

A11105C01

1x52,72 €

GU10 1x5,5W

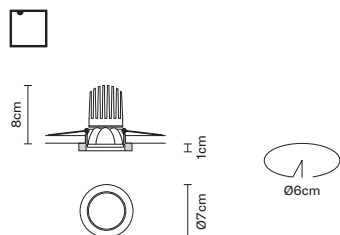

D55 F39
01 White

121,60 €



LED 700mA 10W-40°
WHITE 3000K Cri 80
0,001 m³
0,25 Kg
IP20

D55 F39
11 Polished
aluminium

122,80 €



LED 700mA 10W-40°
WHITE 3000K Cri 80
0,001 m³
0,25 Kg
IP20

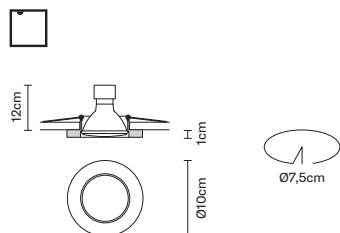

D55 F21
01 White

21,10 €

A11103C20

20x6,06 €

GU10 1x75W
HAGS η 98,00%

0,001 m³
0,30 Kg
IP20

D55 F21
11 Polished
aluminium

23,80 €

A11103C20

20x6,06 €

GU10 1x75W
HAGS η 98,00%

0,001 m³
0,30 Kg
IP20

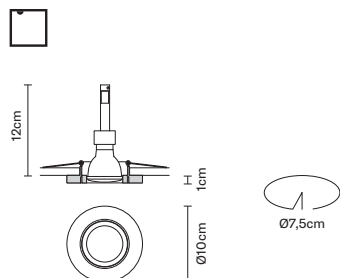

D55 F45
01 White

37,70 €

A11102C20

20x4,69 €

GU10 1x50W
HAGS η 97,10%

0,001 m³
0,30 Kg
IP20

A11105C01

1x52,72 €

GU10 1x5,5W

D55 F45
11 Polished
aluminium

42,50 €

A11102C20

20x4,69 €

GU10 1x50W
HAGS η 97,10%

0,001 m³
0,30 Kg
IP20

A11105C01

1x52,72 €

GU10 1x5,5W

VENERE D55

Francesco Lucchese

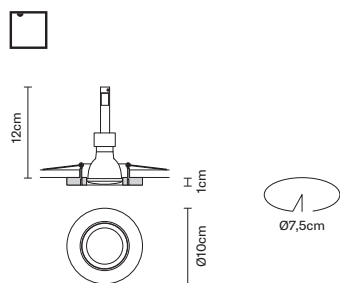

code

price €

bulb code (not incl.)

bulb price €

electrification

technical info / accessories incl.

D55 F46
01 White

37,90 €

A10701C10

10x2,93 €

GU5,3 1x50W
HRGS η 82,40%

0,001 m³
0,30 Kg
IP20

A10705C01

1x47,65 €

GU5,3 1x4W

Accessori p. 200-201 / Accessories p. 200-201

D55 F46
11 Polished aluminium

42,70 €

A10701C10

10x2,93 €

GU5,3 1x50W
HRGS η 82,40%

0,001 m³
0,30 Kg
IP20

A10705C01

1x47,65 €

GU5,3 1x4W

Accessori p. 200-201 / Accessories p. 200-201

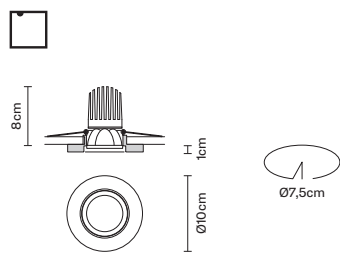

D55 F48
01 White

143,80 €



LED 700mA 10W-40°
WHITE 3000K Cri 80

0,001 m³
0,30 Kg
IP20

D55 F48
11 Polished aluminium

147,80 €



LED 700mA 10W-40°
WHITE 3000K Cri 80

0,001 m³
0,30 Kg
IP20

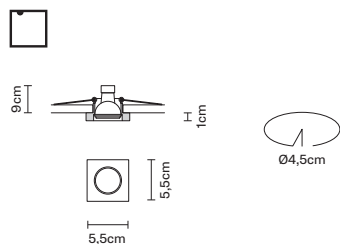

D55 F04
01 White

15,80 €

A10401C10

10x3,71 €

GU4 1x20W
HRGS η 100,00%

0,001 m³
0,20 Kg
IP20

In esaurimento. Accessori p. 200-201 / While stocks last. Accessories p. 200-201

D55 F04
11 Polished aluminium

17,80 €

A10401C10

10x3,71 €

GU4 1x20W
HRGS η 100,00%

0,001 m³
0,20 Kg
IP20

In esaurimento. Accessori p. 200-201 / While stocks last. Accessories p. 200-201

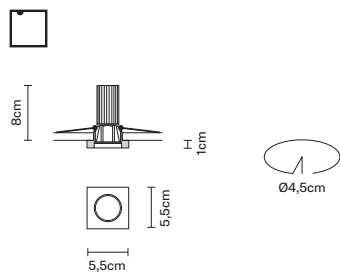

D55 F36
01 White

87,20 €



LED 700mA 3W-40°
WHITE 3000K Cri 80

0,001 m³
0,20 Kg
IP20

In esaurimento / While stocks last

D55 F36
11 Polished aluminium

88,60 €



LED 700mA 3W-40°
WHITE 3000K Cri 80

0,001 m³
0,20 Kg
IP20

In esaurimento / While stocks last

VENERE D55

Francesco Lucchese

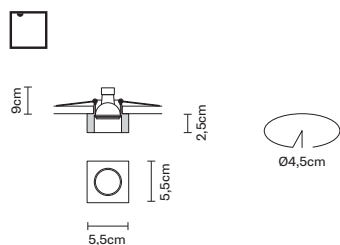

code

price €

bulb code
(not incl.)

bulb price €

electrification

technical info /
accessories incl.

D55 F08
01 White

19,20 €

A10401C10

10x3,71 €

GU4 1x20W
HRGS η 63,00%

0,001 m³
0,20 Kg
IP20

In esaurimento. Accessori p. 200-201 / While stocks last. Accessories p. 200-201

D55 F08
11 Polished
aluminium

21,50 €

A10401C10

10x3,71 €

GU4 1x20W
HRGS η 63,00%

0,001 m³
0,20 Kg
IP20

In esaurimento. Accessori p. 200-201 / While stocks last. Accessories p. 200-201

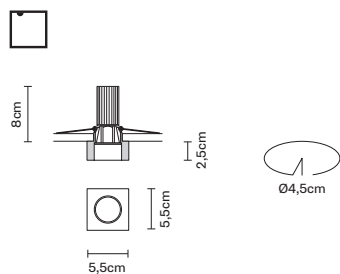

D55 F38
01 White

90,00 €



LED 700mA 3W-40°
WHITE 3000K Cri 80

0,001 m³
0,20 Kg
IP20

D55 F38
11 Polished
aluminium

91,70 €



LED 700mA 3W-40°
WHITE 3000K Cri 80

0,001 m³
0,20 Kg
IP20

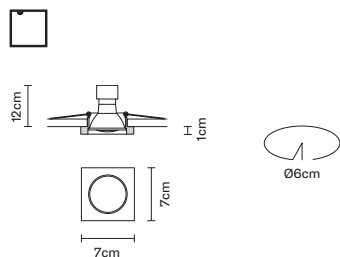

D55 F12
01 White

16,70 €

A10701C10

10x2,93 €

GU5,3 1x50W
HRGS η 82,40%

0,001 m³
0,25 Kg
IP20

A10705C01

1x47,65 €

GU5,3 1x4W

Accessori p. 200-201 / Accessories p. 200-201

D55 F12
11 Polished
aluminium

18,80 €

A10701C10

10x2,93 €

GU5,3 1x50W
HRGS η 82,40%

0,001 m³
0,25 Kg
IP20

A10705C01

1x47,65 €

GU5,3 1x4W

Accessori p. 200-201 / Accessories p. 200-201

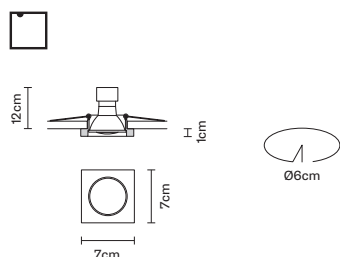

D55 F13
01 White

16,70 €

A11102C20

20x4,69 €

GU10 1x50W
HAGS η 97,10%

0,001 m³
0,25 Kg
IP20

A11105C01

1x52,72 €

GU10 1x5,5W

D55 F13
11 Polished
aluminium

18,80 €

A11102C20

20x4,69 €

GU10 1x50W
HAGS η 97,10%

0,001 m³
0,25 Kg
IP20

A11105C01

1x52,72 €

GU10 1x5,5W

VENERE D55

Francesco Lucchese

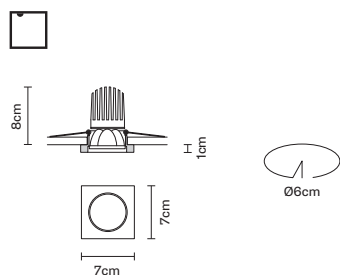

code

price €

bulb code
(not incl.)

bulb price €

electrification

technical info /
accessories incl.

D55 F41
01 White

122,50 €



LED 700mA 10W-40°
WHITE 3000K Cri 80

0,001 m³
0,25 Kg
IP20

D55 F41
11 Polished
aluminium

123,80 €



LED 700mA 10W-40°
WHITE 3000K Cri 80

0,001 m³
0,25 Kg
IP20

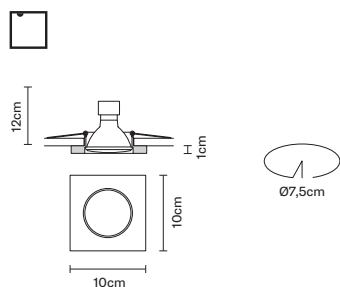

D55 F22
01 White

23,60 €

A11103C20

20x6,06 €

GU10 1x75W
HAGS η 98,00%

0,001 m³
0,35 Kg
IP20

D55 F22
11 Polished
aluminium

26,60 €

A11103C20

20x6,06 €

GU10 1x75W
HAGS η 98,00%

0,001 m³
0,35 Kg
IP20

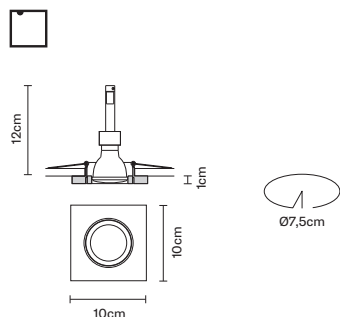

D55 F50
01 White

37,80 €

A11102C20

20x4,69 €

GU10 1x50W
HAGS η 97,10%

0,001 m³
0,30 Kg
IP20

A11105C01

1x52,72 €

GU10 1x5,5W

D55 F50
11 Polished
aluminium

42,50 €

A11102C20

20x4,69 €

GU10 1x50W
HAGS η 97,10%

0,001 m³
0,30 Kg
IP20

A11105C01

1x52,72 €

GU10 1x5,5W

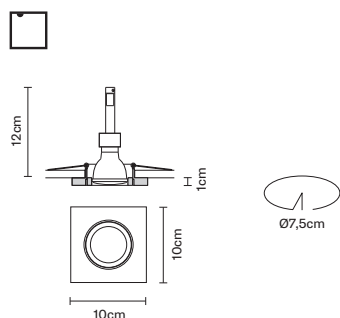

D55 F51
01 White

37,80 €

A10701C10

10x2,93 €

GU5,3 1x50W
HRGS η 82,40%

0,001 m³
0,30 Kg
IP20

A10705C01

1x47,65 €

GU5,3 1x4W

Accessori p. 200-201 / Accessories p. 200-201

D55 F51
11 Polished
aluminium

42,50 €

A10701C10

10x2,93 €

GU5,3 1x50W
HRGS η 82,40%

0,001 m³
0,30 Kg
IP20

A10705C01

1x47,65 €

GU5,3 1x4W

Accessori p. 200-201 / Accessories p. 200-201

VENERE D55

Francesco Lucchese

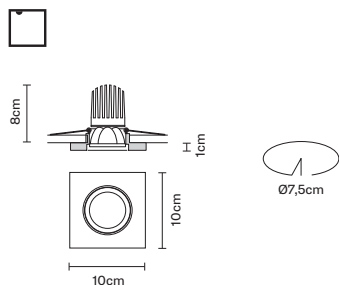

code

price €

bulb code
(not incl.)

bulb price €

electrification

technical info /
accessories incl.

D55 F53
01 White

145,80 €



LED 700mA 10W-40°
WHITE 3000K Cri 80

0,001 m³
0,30 Kg
IP20

D55 F53
11 Polished
aluminium

150,00 €



LED 700mA 10W-40°
WHITE 3000K Cri 80

0,001 m³
0,30 Kg
IP20

VICKY D69

Nicola Gardin - Roger Zanon

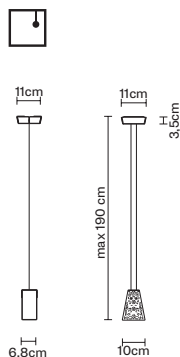

code

price €

bulb code
(not incl.)

bulb price €

electrification

technical info /
accessories incl.

D69 A01
00 Transparent

233,00 €

A11004C20



20x3,91 €

G9 1x60W
HSGS η 88,10%

0,028 m³
2,20 Kg
IP20

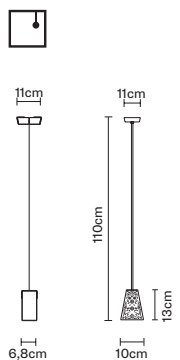

D69 A99
00 Transparent

233,00 €

A11004C20



20x3,91 €

G9 1x60W
HSGS η 88,10%

0,028 m³
2,20 Kg
IP20

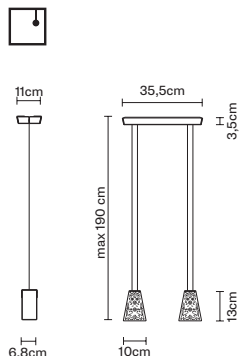

D69 A03
00 Transparent

473,00 €

A11004C20



20x3,91 €

G9 2x60W
HSGS η 88,10%

0,030 m³
4,90 Kg
IP20

VICKY D69

Nicola Gardin - Roger Zanon

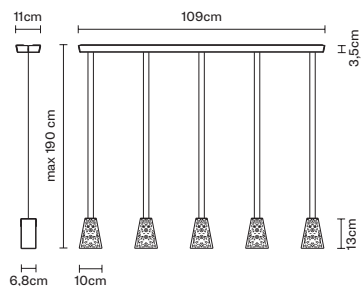

code

price €

bulb code
(not incl.)

bulb price €

electrification

technical info /
accessories incl.

D69 A05
00 Transparent

1.110,00 €

A11004C20

20x3,91 €

G9 5x60W
HSGS η 88,10%

0,072 m³
13,10 Kg
IP20

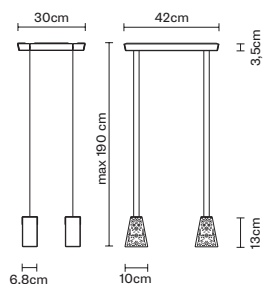

D69 A07
00 Transparent

871,00 €

A11004C20

20x3,91 €

G9 4x60W
HSGS η 88,10%

0,050 m³
10,60 Kg
IP20

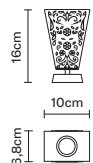

D69 B01
00 Transparent

200,00 €

A11004C20

20x3,91 €

G9 1x60W
HSGS η 88,10%

0,009 m³
1,75 Kg
IP20

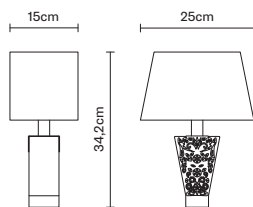

D69 B03
01 White
02 Black

350,00 €

A11003C20 20x3,91 €

G9 1x48W
HSGS

0,036 m³
2,80 Kg
IP20

A11001C20 20x3,91 €

G9 1x20W
HSGS

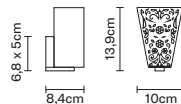

D69 D01
00 Transparent

187,00 €

A11004C20

20x3,91 €

G9 1x60W
HSGS η 88,10%

0,009 m³
1,85 Kg
IP20

VICKY D69

Nicola Gardin - Roger Zanon

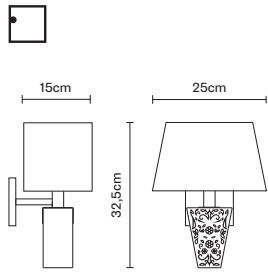

code

price €

bulb code (not incl.)

bulb price €

electrification

technical info / accessories incl.

D69 D03
01 White
02 Black

354,00 €

A11003C20

20x3,91 €

G9 1x48W
HSGS

0,036 m³

2,90 Kg

IP20

A11001C20

20x3,91 €

G9 1x20W
HSGS

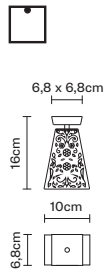

D69 E01
00 Transparent

187,00 €

A11004C20

20x3,91 €

G9 1x60W
HSGS η 88,10%

0,012 m³

2,00 Kg

IP20

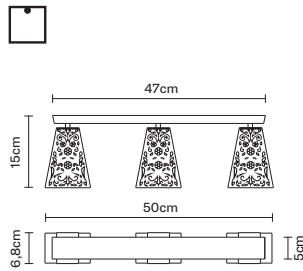

D69 E03
00 Transparent

593,00 €

A11004C20

20x3,91 €

G9 3x60W
HSGS η 86,40%

0,037 m³

5,75 Kg

IP20

WHITE D14

Luca Scacchetti

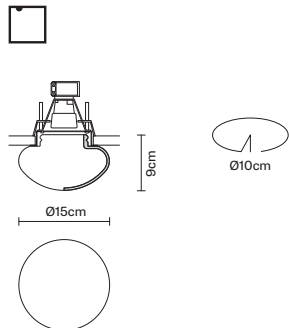

code

price €

bulb code (not incl.)

bulb price €

electrification

technical info / accessories incl.

D14 F48
01 White

95,00 €

A10202C10

10x3,91 €

E27 1x46W
IAP η 81,10%

0,012 m³

2,00 Kg

IP20

IP44

A10210C10

10x10,55 €

E27 1x11W
FBT

ZEN D67

Pamio Design

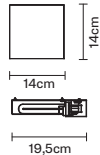

code

price €

**bulb code
(not incl.)**

bulb price €

electrification

**technical info /
accessories incl.**

D67 L01

154,00 €

A12001C10

10x7,23 €

G24q-3 2x26W
FSD

0,008 m³
1,00 Kg
IP20

Cassaforma p. 192-193 / Wallbox p. 192-193

D67 L11

241,00 €

A12001C10

10x7,23 €

G24q-3 2x26W
FSD

0,008 m³
1,10 Kg
IP20

Cassaforma p. 192-193 / Wallbox p. 192-193

D67 L21

348,00 €

A11801C10

10x9,65 €

G24q-3 2x26W
FSD

0,008 m³
1,50 Kg
IP20

Cassaforma p. 192-193 / Wallbox p. 192-193

D67 L45

124,00 €

A10216C10

10x15,66 €

E27 2x18W
FBT

0,008 m³
1,00 Kg
IP20

Cassaforma p. 192-193 / Wallbox p. 192-193

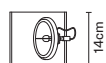
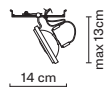

D67 L25

148,00 €

A10602C06

6x13,28 €

G53 1x100W
HMGS η 100,00%

0,008 m³
0,30 Kg
IP20

Cassaforma p. 192-193 / Wallbox p. 192-193

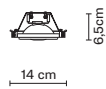

D67 L26

242,00 €

A10602C06

6x13,28 €

G53 1x100W
HMGS η 100,00%

0,008 m³
0,30 Kg
IP20

Cassaforma p. 192-193 / Wallbox p. 192-193

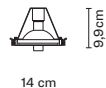

D67 L34

328,00 €

A12701C01

1x79,12 €

GX8,5 1x35W
MR η 100,00%

0,008 m³
0,40 Kg
IP20

Cassaforma p. 192-193 / Wallbox p. 192-193

ZEN D67

Pamio Design

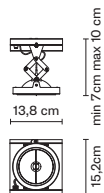

code

price €

bulb code (not incl.)

bulb price €

electrification

technical info / accessories incl.

D67 L37
02 Black

82,00 €

A10602C06

6x13,28 €

G53 1x100W
HMGS η 100,00%

0,008 m³
0,30 Kg
IP20

Accessori p. 200-201 Cassaforma p. 192-193 / Accessories p. 200-201 Wallbox p. 192-193

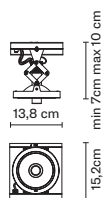

D67 L38
02 Black

118,00 €

A12702C01

1x79,28 €

GX8,5 1x70W
MR η 100,00%

0,008 m³
0,30 Kg
IP20

Accessori p. 200-201 Cassaforma p. 192-193 / Accessories p. 200-201 Wallbox p. 192-193

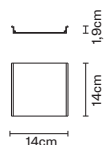

D67 L35

29,00 €

Alluminium / Alluminio

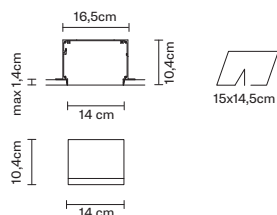

D67 M01

65,00 €

0,005 m³
0,61 Kg

Alluminium / Alluminio

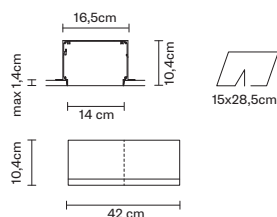

D67 M02

86,00 €

0,019 m³
1,51 Kg

Alluminium / Alluminio

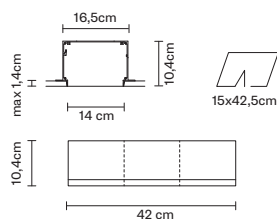

D67 M03

108,00 €

0,037 m³
2,20 Kg

Alluminium / Alluminio

ZEN D67

Pamio Design

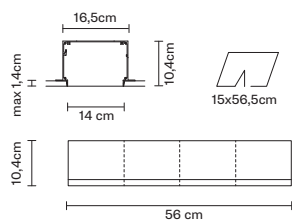

code

price €

bulb code (not incl.)

bulb price €

electrification

technical info / accessories incl.

D67 M04

128,00 €

Alluminium / Alluminio

0,037 m³
2,70 Kg

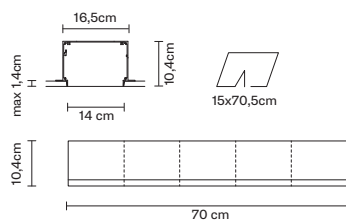

D67 M05

150,00 €

Alluminium / Alluminio

0,038 m³
3,72 Kg

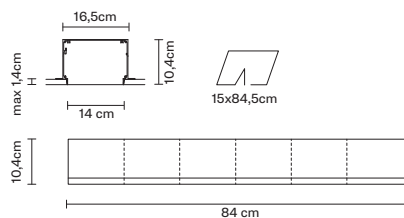

D67 M06

170,00 €

Alluminium / Alluminio

0,080 m³
4,31 Kg

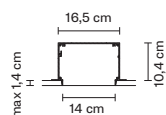

D67 M31
02 Black

71,00 €

Cassaforma 14x14 cm / Wallbox 14x14 cm

0,005 m³
0,61 Kg

D67 M32
02 Black

98,00 €

Cassaforma 14x28 cm / Wallbox 14x28 cm

0,019 m³
1,51 Kg

D67 M33
02 Black

122,00 €

Cassaforma 14x42 cm / Wallbox 14x42 cm

0,037 m³
2,20 Kg

D67 M34
02 Black

150,00 €

Cassaforma 14x56 cm / Wallbox 14x56 cm

0,037 m³
2,70 Kg

MODULI PER CONTROSOFFITTO
/ MODULES FOR FALSE CEILING

ZEN

Pamio Design

codice
/ code

peso
/ weight

COPERTURA / COVER



D67 L35
 Aluminium

-

CASSAFORMA 14x14 cm
 / WALLBOX 14x14 cm



D67 M01
 Aluminium

0,61 Kg

CASSAFORMA 14x28 cm
 / WALLBOX 14x28 cm



D67 M02
 Aluminium

1,51 Kg

CASSAFORMA 14x42 cm
 / WALLBOX 14x42 cm



D67 M03
 Aluminium

2,20 Kg

CASSAFORMA 14x56 cm
 / WALLBOX 14x56 cm



D67 M04
 Aluminium

2,70 Kg

CASSAFORMA 14x70 cm
 / WALLBOX 14x70 cm



D67 M05
 Aluminium

3,72 Kg

CASSAFORMA 14x84 cm
 / WALLBOX 14x84 cm



D67 M06
 Aluminium

4,31 Kg

COPERTURA / COVER

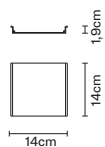

CASSAFORMA 14x14 cm
/ WALLBOX 14x14 cm

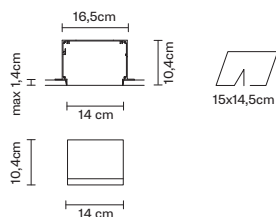

CASSAFORMA 14x28 cm
/ WALLBOX 14x28 cm

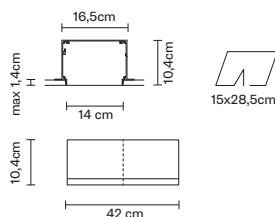

CASSAFORMA 14x42 cm
/ WALLBOX 14x42 cm



CASSAFORMA 14x56 cm
/ WALLBOX 14x56 cm

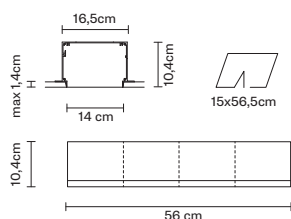

CASSAFORMA 14x70 cm
/ WALLBOX 14x70 cm

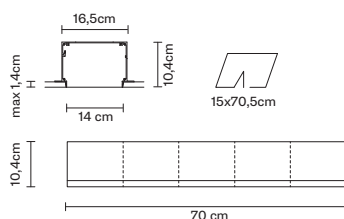

CASSAFORMA 14x84 cm
/ WALLBOX 14x84 cm

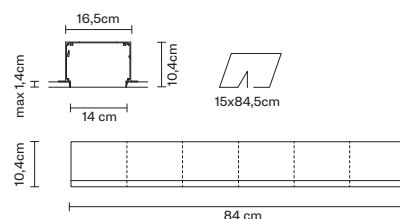

ZEN

Pamio Design

CASSAFORMA 14x14 cm
/ WALLBOX 14x14 cm



codice
/ code

peso
/ weight

D67 M31
02 Black

0,61 Kg

CASSAFORMA 14x28 cm
/ WALLBOX 14x28 cm



D67 M32
02 Black

1,51 Kg

CASSAFORMA 14x42 cm
/ WALLBOX 14x42 cm



D67 M33
02 Black

2,20 Kg

CASSAFORMA 14x56 cm
/ WALLBOX 14x56 cm



D67 M34
02 Black

2,70 Kg

ESEMPI DI APPLICAZIONI / APPLICATION EXAMPLES

14x14 cm

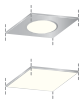

28x14 cm

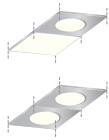

42x14 cm

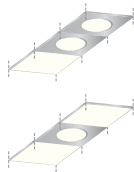

56x14 cm

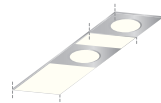

70x14 cm

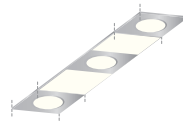

84x14 cm

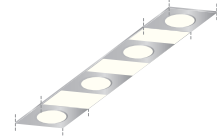

MONTAGGIO / INSTALLATION

Spessore cartongesso 12,5 mm - False ceiling thickness 12,5 mm

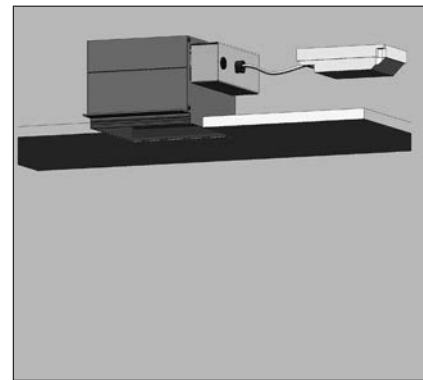
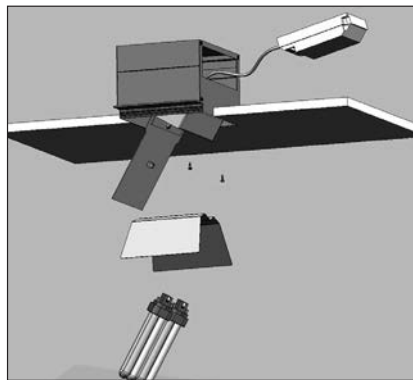
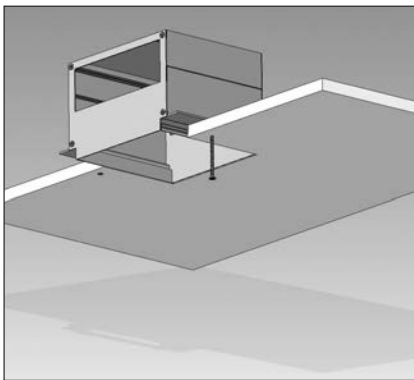

Montaggio modulo incasso per controsoffitto

1. taglio o posizionamento del cartongesso
2. inserimento del Modulo (appoggio su due alette laterali)
3. fissaggio del Modulo al cartongesso con apposite viti
4. stuccatura dei bordi del Modulo

Montaggio del blocco luce

1. collegamento dei cavi di alimentazione
2. inserimento del Blocco Luce
3. fissaggio del Blocco Luce al Modulo con apposite viti

Montaggio del diffusore

1. posizionamento del diffusore all'interno del Modulo fino a portarlo a filo soffitto (solo per fluorescenza)

Recessed module installation on false ceiling

1. cutting or positioning the false ceiling
2. fitting of the Module (using the lateral wings)
3. fixing the Module to the false ceiling using the provided screws
4. surfacing the gap between the false ceiling and the Module

Lighting device installation

1. connecting the electric wires
2. fitting the Lighting Device
3. fixing the Lighting Device inside the Module using provided screws

Diffuser installation

1. fitting the diffuser inside the Module to reach the ceiling level or edge limit surface mounted case (energy saver bulbs only)

Utility

—

Tipologia / Tipology



A
Lampada a sospensione
Hanging lamp
Làmpara de suspensión
Pendelleuchte
Suspension
Подвесной светильник



B
Lampada da tavolo
Table lamp
Làmpara de mesa
Tischleuchte
Lampe à poser
Настольный светильник



C
Lampada da pavimento
Floor lamp
Làmpara de tierra
Stehlampe
Lampadaire
Напольный светильник



D
Lampada da parete
Wall lamp
Appliqué
Wandleuchte
Applique
Настенный светильник



E
Lampada da soffitto
Ceiling lamp
Plafon
Deckenleuchte
Plafonnier
Потолочный светильник



F
Faretto da incasso
Semi-recessed lamp
Empotrable
Deckenleuchte mit eingebauter Steckdose
Spot encastré
Встроенный светильник



G
Lampada da parete e soffitto
Wall and ceiling lamp
Làmpara de techno y pared
Wand-bzw Deckenleuchte
Applique ou plafonnier
Настенно-потолочный светильник



J
Lampada a binario
Light with track fitting
Foco para carril
Schieneenstrahler
Lampe pour rail
Светильник на шинопровде



K
Lampada a morsetto
Light with clamp
Làmpara de pinza
Klemmlampe
Lampe à pince
Светильник на зажиме

Applicazione / Application



Applicazione a soffitto
Ceiling mounting
Montaje en techo
Decken Einbau/Aufbau
Application à plafond
Установки на потолочный



Applicazione a parete
Wall mounting
Montaje en pared
Wand Einbau/Aufbau
Application à mur
Установки на настенный



Applicazione a pavimento
Floor mounting
Montaje en suelo
Fussboden Einbau/Aufbau
Application à sol
Установки на пол

Codice colori / Colour codes

00

Cristallo
Crystal
Cristal
Kristall
Cristal
Прозрачный

01

Bianco
White
Blanco
Weiss
Blanc
Белый

02

Nero
Black
Negro
Schwarz
Noir
Черный

03

Rosso
Red
Roho
Rot
Rouge
Красный

04

Giallo
Yellow
Amarillo
Gelb
Faume
Желтый

05

Acquamarina
Aquamarine
Aigue-marine
Aguamarina
Aquamarin
Аквамарин

06

Azzurro
Light Blue
Azul
Hellblau
Bleu Ciel
Ролубой

10

Azzurro chiaro
Light blue
Azul claro
Aguamarina
Hellblau
Светло-голубой

11

Alluminio Lucido
Polished Aluminium
Aluminio Brillante
Glänzendaluminium
Aluminium Poli
Блестящий алюминий

12

Oro
Gold
Oro
Goldfarben
Or
Золотой

14

Brunito satinato
Satin-finish
burnished
Brufido satinado
Matt braun
Brun cuivré satiné
воронение + сатинирование

15

Cromo
Chrome
Cromo
Chrom
Chrome
Хром

19

Ottonato
Brass-plated
Latonado
Vermessingt
Cuivré
Латунированный

21

Grigio Antracite
Anthracite
Gris Antracita
Anthrazitgrau
Gris Anthracite
Серый антрацит

24

Cromo nero
Black chrome
Cromo negro
Schwarz Chrom
Chrome noir
Черный хром

25

Corten
Corten
Corten
Corten
Corten

26

Marrone scuro
Dark brown
Marrón oscuro
Dunkelbraun
Marron foncé
темно-коричневый

27

Anodizzato
Anodize
Anodizado
Eloxiert
Anodisé
Анодированный

29

Verde scuro
Dark green
Verde oscuro
Dunkelgrün
Vert foncé
Темно-зеленый

30

Grigio Metallizzato
Metallic Grey
Gris Metalico
Metallic-Grau
Gris Métallisé
Серый металл

31

Blu
Blue
Azul
Blau
Bleu
Синий

32

Arancione
Orange
Anaranjado
Orange
Orange
Оранжевый

35

Acciaio Inox Lucido
Polished Stainless Steel
Inox Poli
Glänzendinoxstahl
Acier Inoxidable
Brillante
Блестящая нержавеющая сталь

40

Ametista
Amethyst
Améthyste
Amatista
Amethyst
Аметист

41

Rame
Copper
Cobre
Kupfer
Cuivre
Медь

43

Verde
Green
Verde
Grün
Vert
Зеленый

47

Ambra
Amber
Ambar
Berstein
Ambre
Янтарный

48

Legno colore scuro
Dark wood colour
Madera color oscuro
Dunkelholz Farbe
Bois couleur foncée
Дерево темных тонов

50

Verde chiaro
Light green
Verde claro
Hellgrün
Vert clair
светло-зеленый

51

Cromo Opaco
Opaque Chrome
Cromo Opaco
Chrom Matte
Chrome Opaque
Матовый хром

58

Grigio chiaro
Light grey
Gris claro
Hellgrau
Gris clair
Светло-серый

59

Acciaio Inox Satinato
Satin Stainless Steel
Inox Satinado
Satinert Inoxstahl
Acier Inox Satiné
Сатинированная нержавеющая сталь

60

Bianco 3000K
Warm White 3000K
Blanco 3000K
Weiss 3000K
Blanc 3000K
Белый 3000K

61

Alluminio brillantato
Polished aluminium
Aluminio
abrilantado
Glänzend Alu
Aluminium brilliant
полированный алюминий

62

Bianco 2700K
White 2700K
Blanco 2700K
Weiss 2700K
Blanc 2700K
Белый 2700K

63

Verniciato grigio
Painted grey
Pintado gris
Grau lackiert
Gris clair
серым лаковым покрытием

69

Legno colore chiaro
Light wood colour
Madera color claro
Hellholz Farbe
Bois couleur claire
Дерево светлых тонов

70

Legno colore medio
Intermediate wood colour
Madera color medio
Zwischenholz Farbe
Bois couleur moyenne
Дерево средних тонов

71

Bianco traslucido
Translucent white
Blanco translucido
Durchscheinend weiß
Blanc translucide
белый Полупрозрачный

73

Blu petrolio
Teal blue
Azul petróleo
Petrolblau
Bleu pétrole
Синяя нефть

74

Alluminio dorato
Gold-plated aluminium
Aluminio dorado
Vergoldet Alu
Aluminium doré
позолоченный алюминий

99

Multicolore
Multicolour
Multicolor
Mehrfarbig
Multicolore
Разноцветный

Informazioni tecniche / Technical information



SENSORY
DIMMER

Dimmer sensoriale
Sensory dimmer
Regulador de luz sensorial
Sensorischer dimmer
Variateur sensoriel
Сенсорный диммер



ELECTRONIC
DIMMER

Dimmer elettronico
Electronic dimmer
Regulador de luz electrónico
Elektronischer dimmer
Variateur électronique
Электронный диммер



360°
ADJUSTABLE
SYSTEM

Sistema di inclinazione
Regolable system
Sistema de inclinación
Neigungssystem
Système d'inclinaison
Система изменения наклона



DOUBLE
SWITCH

Doppia accensione
Double switch on-off
Doble encendido
Doppelte einschaltung
Double commutateur d'allumage
Двухлинейное подключение



50% 100%
DOUBLE
BRILLIANCY

Doppia intensità luminosa
Double brilliancy
Doble intensidad luminosa
Doppelte leuchtintensität
Double intensité lumineuse
Два режима яркости (50% и 100%)



1h
EMERGENCY

Autonomia in emergenza
Autonomy in emergency
Autonomia in emergencia
Autonomie im Notfall
Autonomie en emergence
Автономия при аварии



TEMPERED
GLASS

Vetro temperato
Tempered glass
Cristal templado
Gebrannt Glas
Verre trempé
Закаленное стекло

24%
PbO

Cristallo al piombo 24%
24% lead crystal
Cristal al plomo 24%
Bleikristall 24%
Cristal au plomb 24%
Стекло с окисью свинца 24%

Accessori / Accessories



ELECTRONIC
BALLAST

Alimentatore elettronico
Electronic ballast
Fuente de alimentación electrónica
Elektronisches vorschaltgerät
Alimentation électronique
Эпра



DIMMABLE
ELECTRONIC
BALLAST

Alimentatore elettronico dimmerabile
Electronic ballast/dimmer
Fuente de alimentación con intensidad regulable
Dimmbares elektronisches vorschaltgerät
Alimentation électronique à gradation
Эпра под диммер



ELECTRONIC
DRIVER

Driver elettronico
Electronic driver
Driver electrónico
Elektronischer Driver
Driver électronique
Электронный драйвер



DIMMABLE
ELECTRONIC
DRIVER

Driver elettronico dimmerabile
Electronic driver with dimmer
Driver electrónico dimerizable
Elektronischer, dimmbarer Driver
Driver électronique dimmable
Электронный диммируемый драйвер



TOROIDAL
TRANSFORMER

Trasformatore toroidale
Toroidal transformer
Transformador toroidal
Ringkerntransformator
Transformateur torique
Тороидальный трансформатор



ELECTRONIC
TRANSFORMER

Trasformatore elettronico
Electronic transformer
Transformador electrónico
Elektronisches vorschaltgerät
Transformateur électronique
Электронный трансформатор



blue
DICHROIC
FILTERS

Filtro dicroico blu
Blue dichroic filter
Filtro dicroico azul
Dichroitischer filter blau
Filtre dichroïque bleu
Синий дихроичный фильтр



DICHROIC
FILTERS

Filtri dicroici rosso verde blu
Red green blu dichroic filters
Filtros dicroicos rojo verde azul
Dichroitische filter rot grün blau
Filtres dichroïques rouge vert bleu
дихроичные фильтры: красный, зеленый, синий



REMOTE
CONTROL

Telecomando
Remote control
Mando a distancia
Fernbedienung
Télécommande
Пульт дистанционного управления



DALI

Dimmerabile DALI
Dimmable DALI
Dimmerable DALI
Dimmbar DALI
Variateur DALI
Диммируемый DALI



ACCESSORY
FOR POSITION
CHANGING

Sistema di decentramento
Accessory for position changing
Sistema de descentralización
Positionschwechelsystem
Système de décentrag
Система смещения относительно электрического вывода



BALLAST

Alimentatore
Ballast
Fuente de alimentaciòn
Vorschaltgerät
Alimentation
Пра



LED

Led
Led
Led
Led
Led
Светодиод



LAMP
SHADE
INCLUDED

Lampadina inclusa
Light bulb included
Bombilla incluida
Glühbirne inbegriffen
Ampoule incluse
Лампочка включена в поставку

Classe di isolamento / Class of insulation

Ai fini della protezione elettrica, gli apparecchi sono classificati in base ad indicazioni CEE.

For electric production purposes the fixtures are classified in accordance with EEC guidelines.

Para la protección eléctrica los aparatos se clasifican en base a las indicaciones de la CEE.

Die Geräte sind hinsichtlich der elektrischen Absicherung aufgrund der EWG-Normen klassifiziert.

Concernant la protection électrique, les appareils sont classés selon les indications CEE.

С целью электробезопасности все приборы классифицированы в соответствии с инструкциями CEE.

Classe I Isolamento funzionale in ogni parte, provvisto di messa a terra, o con morsetto se fisso o con conduttore e relativa spina con contatto di terra, se mobile.

Class I Functional insulation in every part and ground terminal or clamp in the unit is fixed, with conductor and relative plug with ground contact if the unit is mobile.

Classe I Aislamiento funcional en cada parte provista de toma tierra o con pinza fijada, con cable y terminal con contacto de tierra si es móvil.

Klasse I Isolierung jedes Bestandteiles mit Erdung, bzw. mit Klemme falls festmontiert oder Drahtleitung und Schuko-Stecker falls beweglich.

Classe I Isolement fonctionnel de toutes les composantes, avec mise à la terre ou borne si l'appareil est fixe; avec conducteur et fiche avec contact à la terre si l'appareil est mobile.

Класс I Функциональная изоляция в каждой детали, оснащенная заземлением или с помощью зажима для стационарных изделий, или через проводник и соответствующую вилку с контактом в землю для переносных изделий.



Classe II Doppio isolamento e/o isolamento rinforzato in ogni parte e senza dispositivo di messa a terra.

Class II Double insulation and/or reinforced insulation in every part and without ground devices.

Classe II Doble aislamiento Y/O aislamiento reforzado en cada parte i sin toma tierra.

Klasse II Doppelte Isolierung, bzw. verstärkte Isolierung der Teile, ohne Vorrichtung für Erdung.

Classe II Double isolement et/ou isolement renforcé de toutes les composantes et sans dispositif de mise à la terre.

Класс II Двойная изоляция и/или усиленная в каждой детали и без устройства заземления.



Classe III Apparecchio in cui la protezione contro la scossa elettrica si basa sull'alimentazione a bassissima tensione di sicurezza e in cui non si producono tensioni superiori alla stessa.

Class III Appliance in which protection against electrical shock is guaranteed by the extremely low-voltage power supply and which does not produce higher voltages.

Classe III Aparato en el cual la protección contra la descarga eléctrica se debe a la alimentación a muy baja tensión.

Klasse III Zum Schutz vor elektrischen Schlägen mit Kleinspannung gespeistes Gerät, in dem keine über dem Speisewert liegende Spannung erzeugt werden.

Classe III Appareil avec protection contre les décharges électriques basée sur l'alimentation à une tension de sécurité très basse et sans possibilité de production de tensions supérieures.

Класс III Прибор, в котором защита от электрического удара основана на очень низком напряжении и в котором не возникает напряжение, превышающее, превышающее, указанное.

Marchi di sicurezza / Safety marks



Apparecchio non adatto al montaggio su superfici normalmente infiammabili.

Appliance unsuitable for mounting on normally flammable surfaces.

Aparato no adecuado para la instalación sobre superficies normalmente inflamables.

Das Gerät ist nicht geeignet für eine Montage auf normal entflammbaren Oberflächen.

Appareil non approprié au montage sur surfaces normalement inflammables.

Прибор, непригодный для установки на воспламеняющихся поверхностях.



Divieto d'uso di lampade a luce fredda.

Warning against the use of cool-beam lamps.

Es desaconsejable el uso de bombillas de luz fría.

Verbot Leuchten mit kaltem Licht zu verwenden.

Défense de utiliser ampoules à lumière froide.

Запрещено использовать лампы холодного света.



Distanza minima dagli oggetti illuminati (metri).

Minimum distance from lighted objects (meters).

Distancia mínima de los objetos alumbrados (metros).

Kleinste Entfernung von den beleuchteten Gegenständen (Meter).

Distance minime des objets éclairés (mètres).

Минимальное расстояние от освещенных предметов (м).



Impiego di cavi di alimentazione, di interconnessione o di cablaggio esterno resistente al calore.

Use of heat resistant supply cables, interconnecting cables or external wiring.

Uso de un cable de alimentación, de interconexión o de cableado exterior resistente al calor.

Verwendung einer äußeren hitzebeständigen Verbindungs- oder Verkabelungs- Speiseleitung.

Utilisation d'un câble d'alimentation d'interconnexion ou de câblage extérieur résistant à la chaleur.

Применение термостойкого кабеля: питающего, соединительного или внешней проводки.

Certificazioni / Certification



Gost R EAC

Attesta che il prodotto risulta conforme ai requisiti degli standard russi.

Gost R EAC

This certifies that the product is in conformity with the requirements laid down by the Russian standards.

Gost R EAC

Certifica que el producto resulta conforme a los requisitos propuestos por los estándares rusos.

Gost R EAC

Bescheinigt die Übereinstimmung des Produktes mit den Anforderungen der russischen Standards.

Gost R EAC

Atteste que le produit est conforme aux conditions essentielles proposées par les standards russes.

Gost R EAC

Свидетельствует о соответствии продукции российским стандартам



CSQ

Attesta che la Fabbian Illuminazione s.p.a. attua un sistema qualità conforme alla normativa UNI EN ISO 9001 per garantire la qualità nella progettazione, sviluppo, fabbricazione, commercializzazione, installazione del prodotto.

CSQ

This certifies that Fabbian Illuminazione s.p.a. implements a quality system in conformity with the standard UNI EN ISO 9001 to ensure quality in design, development, manufacture, selling/marketing and installation of the product.

CSQ

Atteste que l'entreprise Fabbian Illuminazione s.p.a. a réalisé un système de qualité conforme à la norme UNI EN ISO 9001 afin de garantir la qualité dans la conception, le développement, la fabrication, la commercialisation et l'installation du produit.

CSQ

Certifica que Fabbian Illuminazione S.p.A. aplica un sistema de calidad conforme a las normas UNI EN ISO 9001 para garantizar la calidad durante el proyecto, desarrollo, fabricación, comercialización e instalación del producto.

CSQ

Bescheinigt, dass die Firma Fabbian Illuminazione s.p.a. ein Qualitätssystem einsetzt, das für die Gewährleistung der Qualität der Planung, Entwicklung, Herstellung, Vermarktung und Installation des Produktes mit den Vorschriften UNI EN ISO 9001 übereinstimmt.

CSQ

Свидетельствует, что Fabbian Illuminazione s.p.a. осуществляет систему качества в соответствие с нормативами UNI EN ISO9001, гарантирующее качество проектирования, разработки, изготовления, продажи, установки изделия.

**Alimentatori, trasformatori, driver, convertitori, dimmer
/ Ballast, transformer, driver, converter, dimmer**

Codice / Code	Descrizione / Description	N. lamp. / N. of bulbs	Applicazioni / Applications									Prezzo € / Price €
			D14	D27	D55	D60	D67	D90	F18	F19		
Fluorescenza Fluorescence												
A30101	Reattore magnetico per lampada TC-D 18W <i>Magnetic ballast for TC-D lamp 18W</i>	max1	D14 F26						D90			1x13,00
A32101	Alimentatore elettronico per lampade 18W TC-D/E TC-T/E <i>Electronic ballast for lamps 18W TC-D/E & TC-T/E</i>	max1	F39									1x22,20
A32102	Alimentatore elettronico per lampade 2x26W TC-D/E TC-T/E <i>Electronic ballast for lamps 2x26W TC-D/E & TC-T/E</i>	max1							F01 F02			1x37,00
A32201	Alimentatore elettronico dimmerabile/dali 2x26W TC-D/E TC-T/E <i>Electronic ballast dimmable/dali for lamps 2x26W TC-D/E & TC-T/E</i>	max1							F01 F02			1x96,70
Ioduri Metallici Metal Halide												
A40201	Alimentatore elettronico per lampade 35W a ioduri metallici <i>Electronic ballast for metal halide lamps 35W</i>	max1						D67	D90			1x71,40
A40202	Alimentatore elettronico per lampade 70W a ioduri metallici <i>Electronic ballast for metal halide lamps 70W</i>	max1						L38	F03 F07			1x42,20
Trasformatori Elettronici dimerabili Dimmable Electronic Transformers												
A22101	Trasformatore elettronico 60W 230/12V (min 10W-max 60W) <i>Electronic transformer 60W 230/12V (min 10W-max 60W)</i>	max1	D14 F06 F07 F38	D27 F02 F10 F18 F62 F04 F12 F29 F06 F14 F52 F08 F16 F57	D55 F09 F46 F12 F51	D60	D67	D90		F19 F02 F24: F05 F31: F11 F41: F21		1x24,15
		max 3			F02 F06 F08	F13 F17 G03	G07 G11					
		max 6					F21 F25					
A22102	Trasformatore elettronico 100W 230/12V (min 35W-max 100W) <i>Electronic transformer 100W 230/12V (min 35W-max 100W)</i>	max1						L37	F09		F50 F60	1x28,75
		max 2	F06 F07 F38	F02 F10 F18 F62 F04 F12 F29 F06 F14 F52 F08 F16 F57	F09 F46 F12 F51						F02 F24: F05 F31: F11 F41: F21	
		min 2 max 5			F02 F06 F08	F13 F17 G03	G07					
		min 4 max 10			F02 F06 F08	F21 F25						
A22201	Trasformatore elettronico 150W 230/12V (min 75W-max 150W) <i>Electronic transformer 150W 230/12V (min 75W-max 150W)</i>	max1						L37				1x40,85
		min 2 max 3	F06 F07 F38	F02 F10 F18 F62 F04 F12 F29 F06 F14 F52 F08 F16 F57	F09 F46 F12 F51						F02 F24: F05 F31: F11 F41: F21	
		min 4 max 7			F02 F06 F08	F13 F17 G03	G07					
		min 8 max 15					F21 F25					
A22202	Trasformatore elettronico 200W 230/12V (min 100W-max 200W) <i>Electronic transformer 200W 230/12V (min 100W-max 200W)</i>	max 2						L37	F09		F50 F60	1x66,95
		min 2 max 4	F06 F07 F38	F02 F10 F18 F62 F04 F12 F29 F06 F14 F52 F08 F16 F57	F09 F46 F12 F51						F02 F24: F05 F31: F11 F41: F21	
		min 5 max 10			F02 F06 F08	F13 F17 G03	G07					
		min 10 max 20					F21 F25					
Trasformatori Elettronici dimerabili per lampadine a led Dimmable Electronic Transformers for led bulbs												
A22105	Trasformatore elettronico 70W 230/12V (min 1W-max 70W) <i>Electronic transformer 70W 230/12V (min 1W-max 70W)</i>	min 1 max 17	D14 F06 F07 F38	D27 F02 F10 F18 F62 F04 F12 F29 F06 F14 F52 F08 F16 F57	D55 F09 F46 F12 F51	D60				F19 F02 F24: F05 F31: F11 F41: F21		1x36,00
		max 4									F50 F60	
Driver Elettronici 24V/dc Electronic Drivers 24V/dc												
A50307	Driver elettronico dimmerabile multitemperatura/multicorrente 15W 24V/dc <i>Dimmable electronic driver multivoltage/multicurrent 15W 24V/dc</i>	max1								F18 F01 F02		1x65,50
A22005	Driver elettronico 30W 24V/dc <i>Electronic driver 30W 24V/dc</i>	max 2								F01 F02		1x77,05

















Alimentatori, trasformatori, driver, convertitori, dimmer / Ballast, transformer, driver, converter, dimmer

Codice / Code	Descrizione / Description	N. lamp. / N. of bulbs	Applicazioni / Applications					Prezzo € / Price €	
			D14	D27	D55	D60	F19		
Trasformatori Toroidali / Toroidal Transformers									
A22002	Trasformatore toroidale 50W 230/12V IP67 <i>Toroidal transformer 230/12V 50W IP67</i>	max 1	F06 F07 F08 F09 F10	F12 F14 F15 F16 F18 F19 F20 F21 F22 F23	F25 F26 F27 F28 F29	F09 F12 F23	F46 F51	1 x 42,26	
		max 2				F02 F06	F06 F17	F13 G03 G07	
		max 5						F21 F25	
Convertitori per LED di Potenza / Drivers For Brightness Leds									
A50101	Convertitore per LED di potenza da 350mA (max 15W) <i>Converter for high brightness LEDs 350mA (max 15W)</i>	max 1		D27				D60	F19 F03 F22 F25
		max 3						G01	
		max 9						F23 F24	
A50105	Convertitore per LED di potenza da 700mA (max 12W) <i>Converter for high brightness LEDs 700mA (max 12W)</i>	max 4						F27 F28	
A50103	Convertitore per LED di potenza da 700mA (min 9W-max 27W) <i>Converter for high brightness LEDs 700mA (min 9W-max 27W)</i>	max 2	F54 F55 F56 F57	F31 F33 F35 F37 F39	F40 F43 F44 F47 F49	F54 F59 F64 F68 F73	F69 F70 F71 F72 F73	F74 F75 F76 F77 F78	F82 F83 F84 F85 F86
		min 3 max 9						F27 F28	
A50106	Convertitore per LED di potenza da 500mA (max 20W) <i>Converter for high brightness LEDs 500mA (max 20W)</i>	max 1							F53 F54 F63
A50107	Convertitore dimmerabile per LED di potenza da 500/700mA (max 20W) push 1.10V <i>Dimmable converter for high brightness LEDs 500/700mA (max 20W) push 1.10V</i>	max 1	F54 F55 F56 F57	F31 F33 F35 F37 F39	F40 F43 F44 F47 F49	F54 F59 F64 F68 F73	F69 F70 F71 F72 F73	F74 F75 F76 F77 F78	F82 F83 F84 F85 F86
A50108	Convertitore per LED di potenza da 500mA (max 12W) <i>Converter for LEDs 500 mA (max 12W)</i>	max 1						F15 F16 F19 F20 G05	G06 G09 G10
A50109	Convertitore per LED di potenza da 700mA (max 17W) <i>Converter for LEDs 700 mA (max 17W)</i>	max 1		F31 F33 F35 F37 F39	F40 F43 F44 F47 F49	F54 F59 F64 F68 F73	F69 F70 F71 F72 F73	F74 F75 F76 F77 F78	F82 F83 F84 F85 F86
Dimmer per piantana / Floor lamp dimmer									
A60101	Dimmer elettronico max 300W <i>Electronic dimmer max 300W</i>	max 1		D49C01 D57C11	D57C01 D75C01				
Alimentatori per strip LED / Ballast for LED strip									
A50207	Alimentatore a tensione costante 35W 24Vdc <i>LED power supply constant voltage 35W 24Vdc</i>								1 x 37,49
A50208	Alimentatore a tensione costante 60W 24Vdc <i>LED power supply constant voltage 60W 24Vdc</i>								1 x 39,36
A50209	Alimentatore a tensione costante 100W 24Vdc <i>LED power supply constant voltage 100W 24Vdc</i>								1 x 73,03
A50210	Alimentatore a tensione costante 150W 24Vdc <i>LED power supply constant voltage 150W 24Vdc</i>								1 x 101,93
Casseforme per calcestruzzo / Wallboxes for concrete									
A70405	Cassaforma per faretto a tensione di rete <i>Wallbox for mains voltage spots</i>	max 1				D27	D55	D60	1 x 18,26
A70406	Cassaforma per faretto a bassa tensione e LED <i>Wallbox for low-voltage spots and LED</i>	max 1							1 x 27,34















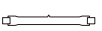

Alimentatori per Laminis, Tile e Pivot / Led power for Laminis, Tile and Pivot

Codice / Code	Descrizione / Description	Lunghezze barre (cm) / Bar length (cm)	Prezzo € / Price €
A50202	Alimentatore a tensione costante 20W 24Vdc, dimmerabile 1.10V <i>LED power supply constant voltage 20W 24 Vdc, dimmable 1.10V</i>	max 30 cm	1 x 46,75
A50203	Alimentatore a tensione costante 25W 24Vdc, dimmerabile 1.10V <i>LED power supply constant voltage 25W 24 Vdc, dimmable 1.10V</i>	max 60 cm	1 x 81,95
A50204	Alimentatore a tensione costante 40W 24Vdc, dimmerabile 1.10V <i>LED power supply constant voltage 40W 24 Vdc, dimmable 1.10V</i>	max 120 cm	1 x 97,35
A50205	Alimentatore a tensione costante 60W 24Vdc, dimmerabile 1.10V <i>LED power supply constant voltage 60W 24 Vdc, dimmable 1.10V</i>	max 210 cm	1 x 101,75
A50206	Alimentatore a tensione costante 90W 24Vdc, dimmerabile 1.10V <i>LED power supply constant voltage 90W 24 Vdc, dimmable 1.10V</i>	max 300 cm	1 x 117,15
A50308	Kit per controllo Dali (4 canali d'uscita) e Push <i>Dali (4 output channel) and Push kit control</i>		1 x 95,70













Indice lampadine
/ Bulbs index

Lampadine / Bulbs	Descrizione / Description	Codice / Code	Qtà / Qty (nr)	Potenza / Power (W)	Tensione / Volt (V)	Attacco / Socket	Fascio luce / Light beam	Flusso luce / Light flux (lumen)	Intensità luminosa / Lighting power (cd)	Temp. colore / Light temp. (Kelvin)	Codice ILCOS L / Code ILCOS L	Tipo / Type	Prezzo €/ Price €
Lampadine alogene / Halogen bulbs													
	sfera chiara clear sphere	A10101C10	10	30	230	E14		405		2700	HSGSB	P45	10 x 4,69
		A10102C10	10	46				700					10 x 5,00
		A10113C10	10	20				235					10 x 4,69
	cupola argentata silver top	A10103C10	10	40	230	E14		340		2700	IRP/S	P45	10 x 8,99
	sfera chiara clear sphere	A10202C10	10	46	230	E27		700		2700	HSGSA	A60	10 x 3,91
		A10221C10	10	57				915					10 x 4,69
		A10222C10	10	77				1320					10 x 4,69
	cupola argentata silver top	A10203C10	10	60	230	E27		550		2700	IRP/S	A65	10 x 6,25
		A10204C10	10	100				1100					10 x 4,89
	lampadina con riflettore bulb with reflector	A10220C01	1	75	230	E27	12°		7200	2800	HAGS	PAR38	1 x 17,58
Lampadine fluorescenti / Fluorescent bulbs													
	sfera fluorescente fluorescent sphere	A10223C10	10	9	230	E27		430		2500	FBG	P45	10 x 12,50
	sfera fluorescente fluorescent sphere	A10105C10	10	6	230	E14		230		2500	FBC	P45	10 x 13,20
	sfera fluorescente fluorescent sphere	A10211C10	10	11	230	E27		520		2500	FBG	A60	10 x 12,50
		A10212C10	10	15				800					10 x 13,98
		A10213C10	10	20				1152					10 x 17,19
	sfera fluorescente fluorescent sphere	A10229C01	01	23	230	E27		1371		2700	FBC		1 x 19,53
	fluorescenza elettronica fluorescent electronic	A10214C10	10	11	230	E27		640		2500	FBT	Energy saving	10 x 13,67
		A10215C10	10	14				820					10 x 15,35
		A10216C10	10	18				1140					10 x 15,66
		A10217C10	10	22				1440					10 x 18,36
		A10218C10	10	30				1940					10 x 23,63
		A10106C10	10	11				230					E14
	fluorescenza compatta compact fluorescent	A10210C10	10	11	230	E27		660		2500	FBT		10 x 10,55
	fluorescenza compatta compact fluorescent	A11701C10	10	18	230	G24d-2		1200		3000	FSD	TC-D	10 x 5,67
		A11801C10	10	18				1200					10 x 9,65
		A11901C10	10	26				1800					10 x 5,67
		A12001C10	10	26				1800					10 x 7,23
		A12201C10	10	18				230					GX24q-2
A12101C10	10	26	230	GX24d-3	1800			10 x 12,89					
	fluorescenza compatta compact fluorescent	A11604C10	10	24	230	2G11		1800		3000	FSD	TC-L	10 x 9,18
		A11601C10	10	36				2900					10 x 9,96
		A11602C10	10	55				4800					10 x 9,77
		A11603C10	10	80				6000					10 x 10,94
	fluorescenza fluorescent	A10501C04	4	24	230	G5		2000		3000	FD	T5	4 x 7,81
		A10502C04	4	39				3500					4 x 10,35
		A10503C04	4	54				5000					4 x 9,18
		A10504C04	4	80				7000					4 x 9,57
	fluorescenza fluorescent	A10505C04	4	24	230	G5		1750		3000	FD		4 x 24,22
		A10506C04	4	39				3100					4 x 28,71
		A10507C04	4	54				4450					4 x 28,71
	fluorescenza elettronica fluorescent electronic	A12601C01	1	6	230	GX53		220		3000	FBC		1 x 31,64







Indice lampadine / Bulbs index

Lampadine / Bulbs	Descrizione / Description	Codice / Code	Q.tà / Q.ty (nr)	Potenza / Power (W)	Tensione / Volt (V)	Attacco / Socket	Fascio luce / Light beam	Flusso luce / Light flux (lumen)	Intensità luminosa / Lighting power (cd)	Temp. colore / Light temp. (Kelvin)	Codice ILCOS L / Code ILCOS L	Tipo / Type	Prezzo €/ Price €
Lampadine alogene / Halogen bulbs													
	alogena halogen	A10205C15	15	100	230	E27	30°		3500	2900	HAGS/UB	PAR30	15 x 12,10
	alogena chiara clear halogen	A10207C12 A10208C12 A10209C12	12 12 12	100 150 205	230	E27		1800 2870 4200		2900	HSGST	QT-32	12 x 16,41 12 x 16,41 12 x 16,80
	alogena chiara clear halogen	A11001C20 A11002C20 A11003C20 A11004C20	20 20 20 20	20 33 48 60	230	G9		235 460 740 980		2700	HSGST	Halopin Bipin Hipin	20 x 3,91 20 x 3,91 20 x 3,91 20 x 3,91
Lampadine alogene / Halogen bulbs													
	alogena halogen	A10301C10 A10302C10 A10304C10 A10306C10	10 10 10 10	10 20 35 5	12	G4		130 300 600 55		2800	HSGS	QT-9	10 x 0,94 10 x 0,94 10 x 0,94 10 x 0,94
	alogena halogen	A10803C10 A10802C10 A10801C10	10 10 10	20 25 35	12	GY6,35		320 500 860		2900	HSGS	QT-12	10 x 1,57 10 x 6,25 10 x 6,25
	alogena (118 mm) halogen (118 mm)	A11505C20 A11506C20 A11507C20	20 20 20	120 160 230	230			2250 3100 5000		2900	HDG	QT-DE12	20 x 6,25 20 x 6,25 20 x 7,03
	alogena (78 mm) halogen (78 mm)	A11501C20 A11504C20 A11502C20 A11503C20	20 20 20 20	48 60 80 120	230	R7s		750 800 1400 2250		2900	HDG	QT-DE12	20 x 7,42 20 x 7,42 20 x 6,25 20 x 7,42
	alogena dicroica dichroic halogen	A10401C10 A10402C10	10 10	20 35	12	GU4	38° 38°	580 1000		3000	HRGS		10 x 3,71 10 x 3,71
	alogena alluminizzata aluminized halogen	A11101C20 A11102C20 A11103C20	20 20 20	50 50 75	230	GU10	25° 40° 25°	350 350 1500 800 2500		2900	HAGS/UB	Ø64mm Ø51mm	20 x 10,16 20 x 4,69 20 x 6,06
	alogena alluminizzata aluminized halogen	A10701C10	10	50	12	GU5,3	38°	1800		2900	HAGS/UB		10 x 2,93
	alogena dicroica dichroic halogen	A10703C10 A10702C10 A10704C10	10 10 10	50 20 50	12	GU5,3	10° 38° 38°	15000 1000 2850		3000	HRGS		10 x 7,46 10 x 7,46 10 x 7,61
	alogena alluminizzata aluminized halogen	A10601C06 A10602C06	6 6	50 100	12	G53	24° 45°	4000 2800		2900	HMGS/UB		6 x 14,53 6 x 13,28
Alogenuri / Metal halide													
	alogenuri metal halide	A11201C01	1	35	230	GX10	40°	4000		3000	MR		1 x 66,90
	alogenuri metal halide	A12701C01 A12702C01	1 1	35 70	230	GX8,5	40° 40°	3300 6600	4000 9000	3000	MR	PAR30	1 x 79,12 1 x 79,28
	alogenuri metal halide	A11301C01 A11302C01	1 1	35 70	230	G12		3600 7300		3000	MT		1 x 51,28 1 x 46,86
	alogenuri metal halide	A10901C01	1	70	230	G8,5		6500		3000	MT		1 x 51,28
Vapori di sodio / Sodium vapor													
	vapori di sodio sodium vapor	A11401C01	1	100		GX12-1		4900		2550	MT		1 x 94,23

Indice lampadine / Bulbs index

Lampadine / Bulbs	Descrizione / Description	Codice / Code	Q.tà / Qty (nr)	Potenza / Power (W)	Tensione / Volt (V)	Attacco / Socket	Fascio luce / Light beam	Flusso luce / Light flux (lumen)	Intensità luminosa / Lighting power (cd)	Temp. colore / Light temp. (Kelvin)	Codice ILCOS L / Code ILCOS L	Tipo / Type	Prezzo € / Price €
Led / Leds													
	led dimmerabile dimmable leds	A1011C01	1	3,5	230	E14		250		2700		P45 CL Philips®	1 x 39,56
	led dimmerabile dimmable leds	A10225C01	1	9,5	230	E27		806		2700		A60 Philips®	1 x 74,20
	led dimmerabile dimmable leds	A10226C01	1	18	230	E27		1521		2700		A67 Philips®	1 x 109,34
	led dimmerabile dimmable leds	A10227C01	1	14,5	230	E27	25°	900	4700	2700		PAR38 Philips®	1 x 101,53
	led dimmerabile dimmable leds	A10228C01	1	9,5	230	E27	25°	650	3500	2700		PAR30 Philips®	1 x 131,21
	led leds	A10307C01	1	3	12	G4		195		2700			1 x 25,39
	led leds	A10705C01	1	4	12	GU5,3	24°	210	1100	3000		MR16 Philips®	1 x 47,65
	led dimmerabile dimmable leds	A10603C01	1	15	12	G53	40°	840		3000		AR111 Philips®	x 140,58
	led dimmerabile dimmable leds	A11105C01	1	5,5	230	GU10	25°	375	1200	3000		MR16 Philips®	1 x 52,72
Strip, barre lineari e lenti per LED / LED strips, linear bars and lens													
	strip LED (al metro) LED strips (by meter)	A50503	1	28,8	24			2600		3000			1 x 39,00
	Lente LED 30° / LED lens 30°	A50601	1										1 x 5,45
	strip LED (5 metri, IP20) LED strips (5 metres, IP20)	A50504	1	144	24			2600/m		3000			1 x 117,15
	strip LED (5 metri, IP65) LED strips (5 metres, IP65)	A50505	1	144	24			2600/m		3000			1 x 128,87
	Profilo in alluminio con lente 30°, clips e tappi (2 metri) / Aluminium bar with lens 30°, clips and caps (2 meters)	A50602	1										1 x 11,39
	Profilo in alluminio con diffusore, clips e tappi (2 metri) / Aluminium bar with diffusor, clips and caps (2 meters)	A50603	1										1 x 8,25

Accessori a binario / Track accessories

Immagine del prodotto / Still life	Descrizione / Description	Codice / Code	Colore / Colour	Informazioni / Item information	Applicazioni / Applications	Prezzo € / Price €
	Binario monofase a 3 accensioni Single phase 3 circuits tracks 230V - 16A	A60201 01 A60201 02 A60201 27	bianco white nero black grigio grey	Soffitto Ceiling cm 100	D57 J - D70 J	1x52,80
		A60202 01 A60202 02 A60202 27	bianco white nero black grigio grey	Soffitto Ceiling cm 200	D57 J - D70 J	1x93,28
		A60203 01 A60203 02 A60203 27	bianco white nero black grigio grey	Soffitto Ceiling cm 300	D57 J - D70 J	1x149,60
	Binario monofase a 3 accensioni Single phase 3 circuits tracks 230V - 16A	A60204 01 A60204 02 A60204 27	bianco white nero black grigio grey	Controsoffitto Counter ceiling cm 100	D57 J - D70 J	1x61,60
		A60205 01 A60205 02 A60205 27	bianco white nero black grigio grey	Controsoffitto Counter ceiling cm 200	D57 J - D70 J	1x118,80
		A60206 01 A60206 02 A60206 27	bianco white nero black grigio grey	Controsoffitto Counter ceiling cm 300	D57 J - D70 J	1x171,60
	Congiunzione Straight connector	A60207 01 A60207 02 A60207 27	bianco white nero black grigio grey	Congiunzione Straight connector	D57 J - D70 J	1x12,32
	Congiunzione Connector	A60208 01 A60208 02 A60208 27	bianco white nero black grigio grey	Giunto flessibile per soffitto Connector flexible for ceiling	D57 J - D70 J	1x92,40
	Congiunzione Connector	A60209 01 A60209 02 A60209 27	bianco white nero black grigio grey	Giunto 90° per controsoffitto Connector 90° for counter ceiling	D57 J - D70 J	1x57,20
	Alimentazione Feeder	A60210 01 A60210 02 A60210 27	bianco white nero black grigio grey	Alimentazione DX con testata di chiusura Feeder DX with head end	D57 J - D70 J	1x19,80
		A60211 01 A60211 02 A60211 27	bianco white nero black grigio grey	Alimentazione SX con testata di chiusura Feeder SX with head end	D57 J - D70 J	1x19,80

Grado di protezione IP / IP protection

Il grado di protezione degli apparecchi di illuminazione viene indicato con la sigla IP (International Protection) seguita da due cifre caratteristiche. La prima di queste due cifre descrive la protezione che questi possiede contro la penetrazione di corpi solidi. La seconda indica la protezione nei confronti dei liquidi.

Gradi di protezione indicati dalla prima cifra

- 0 Non protetto
- 1 Protetto contro la penetrazione di corpi solidi di dimensioni maggiori a 50 mm
- 2 Protetto contro la penetrazione di corpi solidi di dimensioni maggiori a 12 mm
- 3 Protetto contro la penetrazione di corpi solidi di dimensioni maggiori a 2,5 mm
- 4 Protetto contro la penetrazione di corpi solidi di dimensioni maggiori a 1 mm
- 5 Protetto contro la polvere
- 6 Totalmente protetto contro la polvere

Gradi di protezione indicati dalla seconda cifra

- 0 Non protetto
- 1 Protetto contro lo stillicidio
- 2 Protetto contro lo stillicidio, con un'inclinazione fino a 15°
- 3 Protetto contro la pioggia
- 4 Protetto contro gli spruzzi d'acqua
- 5 Protetto contro i getti d'acqua
- 6 Protetto contro le onde
- 7 Stagno all'immersione
- 8 Stagno alla sommersione

The protection rating of lighting appliances is shown by the letters IP (international protection) followed by two characteristic digits. The first of these two digits indicates the degree of protection that the appliances offer against the ingress of solid foreign objects. The second indicates the protection against the ingress of water.

Protection ratings indicated by the first digit

- 0 No protection
- 1 Protected against entry of solid objects larger than 50 mm
- 2 Protected against entry of solid objects larger than 12 mm
- 3 Protected against entry of solid objects larger than 2,5 mm
- 4 Protected against entry of solid objects larger than 1 mm
- 5 Protected against dust
- 6 Completely protected against dust

Protection ratings indicated by the second digit

- 0 No protection
- 1 Protected against vertically falling drops of water
- 2 Protected against vertically falling drops of water when appliance is tilted up to 15°
- 3 Protected against rain
- 4 Protected against water spray from all directions
- 5 Protected against water jets
- 6 Protected against heavy seas, flooding
- 7 Sealed against immersion up to 1 metre
- 8 Sealed against submersion over 1 metre

El grado de protección de los aparatos de iluminación se indica con la sigla IP (International Protection) seguida por dos dígitos de identificación característicos. La primera cifra indica el grado de protección de los aparatos contra la penetración de los cuerpos sólidos. La segunda cifra indica la protección contra los líquidos.

Grados de protección comunicados por la primera cifra

- 0 Sin protección
- 1 Protección contra la penetración de cuerpos sólidos de dimensiones superiores a 50 mm
- 2 Protección contra la penetración de cuerpos sólidos de dimensiones superiores a 12 mm
- 3 Protección contra la penetración de cuerpos sólidos de dimensiones superiores a 2,5 mm
- 4 Protección contra la penetración de cuerpos sólidos de dimensiones superiores a 1 mm
- 5 Protección contra el polvo
- 6 Protección total contra el polvo

Grados de protección comunicados por la segunda cifra

- 0 Sin protección
- 1 Protección contra la caída vertical de gotas de agua
- 2 Protección contra la caída vertical de gotas de agua con una inclinación máxima de 15°
- 3 Protección contra la lluvia
- 4 Protección contra las salpicaduras de agua
- 5 Protección contra los chorros de agua
- 6 Protección contra las olas
- 7 Protección contra los efectos de la inmersión
- 8 Protección contra los efectos de la sumersión

Der Schutzgrad von Beleuchtungsgeräten wird mit der Abkürzung IP (international protection) gefolgt von einer charakteristischen zweistelligen Zahl angegeben. Die erste dieser beiden Ziffern beschreibt den Schutz, den die Beleuchtungsgeräte gegen das Eindringen von Festkörpern besitzen. Die zweite Ziffer gibt den Schutz gegenüber Flüssigkeiten an.

Von der ersten ziffer angegebene schutzgrade

- 0 Nicht geschützt
- 1 Geschützt gegen das Eindringen von Festkörpern mit einer Größe über 50 mm
- 2 Geschützt gegen das Eindringen von Festkörpern mit einer Größe über 12 mm
- 3 Geschützt gegen das Eindringen von Festkörpern mit einer Größe über 2,5 mm
- 4 Geschützt gegen das Eindringen von Festkörpern mit einer Größe über 1 mm
- 5 Gegen Staub geschützt
- 6 Vollständig gegen Staub geschützt

Von der zweiten ziffer angegebene schutzgrade

- 0 Nicht geschützt
- 1 Geschützt gegen Tropfwasser
- 2 Geschützt gegen Tropfwasser mit einer Neigung bis zu 15°
- 3 Geschützt gegen Regen
- 4 Geschützt gegen Wasserspritzer
- 5 Geschützt gegen Wasserstrahl
- 6 Geschützt gegen Wellen
- 7 Dicht bei zeitweiligem Eintauchen
- 8 Dicht bei dauerndem Untertauchen

Le degré de protection des appareils d'éclairage est indiqué avec le sigle IP (International Protection) suivi par deux chiffres caractéristiques. Le premier de ces deux chiffres décrit la protection que l'appareil possède contre la pénétration de corps solides. Le deuxième chiffre indique la protection vis-à-vis des liquides.

Degrés de protection indiqués par le premier chiffre

- 0 Non protégé
- 1 Protégé contre la pénétration de corps solides de dimensions supérieures à 50 mm
- 2 Protégé contre la pénétration de corps solides de dimensions supérieures à 12 mm
- 3 Protégé contre la pénétration de corps solides de dimensions supérieures à 2,5 mm
- 4 Protégé contre la pénétration de corps solides de dimensions supérieures à 1 mm
- 5 Protégé contre la poussière
- 6 Totalement protégé contre la poussière

Degrés de protection indiqués par le deuxième chiffre

- 0 Non protégé
- 1 Protégé contre les gouttes d'eau
- 2 Protégé contre les gouttes d'eau, avec une inclinaison jusqu'à 15°
- 3 Protégé contre la pluie
- 4 Protégé contre les éclaboussures d'eau
- 5 Protégé contre les jets d'eau
- 6 Protégé contre les ondes
- 7 Étanche à l'immersion
- 8 Étanche à la submersion

Степень защиты осветительных приборов обозначена буквами IP (international protection) и двумя цифрами. Первая цифра указывает степень защиты от проникновения твердых частиц. Вторая цифра указывает степень защиты от проникновения жидкостей.

0 Не защищен

- 1 Защищен от проникновения твердых частиц диаметром больше 50 мм
- 2 Защищен от проникновения твердых частиц диаметром больше 12 мм
- 3 Защищен от проникновения твердых частиц диаметром больше 2,5 мм
- 4 Защищен от проникновения твердых частиц диаметром больше 1 мм
- 5 Защищен от пыли
- 6 Полностью защищен от пыли

0 Не защищен

- 1 Защищен от просачивания
- 2 Защищен от просачивания с наклоном до 15°
- 3 Защищен от дождя
- 4 Защищен от водяных брызг
- 5 Защищен от водяных струй
- 6 Защищен от волн
- 7 Водонепроницаем при погружении
- 8 Водонепроницаем при затоплении

IP20

Protetto contro la penetrazione di corpi solidi di dimensioni maggiori a 12 mm. Non protetto nei confronti dei liquidi.

Protected against entry of solid objects larger than 12 mm. No protection against the ingress of water.

Protección contra la penetración de cuerpos sólidos de dimensiones superiores a 12 mm. Sin protección contra los líquidos.

Flüssigkeiten an Geschützt gegen das Eindringen von Festkörpern mit einer Größe über 12 mm. Nicht geschützt Schutz gegenüber.

Protégé contre la pénétration de corps solides de dimensions supérieures à 12 mm. Non protégé vis-à-vis des liquides.

Защищен от проникновения твердых частиц диаметром больше 12 мм. Не защищен от водяных брызг.

IP21

Protetto contro la penetrazione di corpi solidi di dimensioni maggiori a 12 mm. Non protetto contro lo stillicidio.

Protected against entry of solid objects larger than 12 mm. Protected against vertically falling drops of water.

Protección contra la penetración de cuerpos sólidos de dimensiones superiores a 12 mm. Protección contra la caída vertical de gotas de agua.

Geschützt gegen das Eindringen von Festkörpern mit einer Größe über 12mm. Geschützt gegen Tropfwasser.

Protégé contre la pénétration de corps solides de dimensions supérieures à 12mm. Protégé contre les gouttes d'eau.

Защищен от проникновения твердых частиц диаметром больше 12 мм. Защищен от просачивания.

IP40

Protetto contro la penetrazione di corpi solidi di dimensioni maggiori a 1 mm. Non protetto nei confronti dei liquidi.

Protected against entry of solid objects larger than 1 mm. No protection against the ingress of water.

Protección contra la penetración de cuerpos sólidos de dimensiones superiores a 1 mm. Sin protección contra los líquidos.

Geschützt gegen das Eindringen von Festkörpern mit einer Größe über 1 mm. Nicht geschützt Schutz gegenüber.

Protégé contre la pénétration de corps solides de dimensions supérieures à 1 mm. Non protégé contre les éclaboussures.

Защищен от проникновения твердых частиц диаметром более 1 мм. Не защищен от водяных брызг.

IP41

Protetto contro la penetrazione di corpi solidi di dimensioni maggiori a 1 mm. Protetto contro lo stillicidio.

Protected against entry of solid objects larger than 1 mm. Protected against vertically falling drops of water.

Protección contra la penetración de cuerpos sólidos de dimensiones superiores a 1 mm. Protección contra la caída vertical de gotas de agua.

Geschützt gegen das Eindringen von Festkörpern mit einer Größe über 1 mm. Geschützt gegen Tropfwasser.

Protégé contre la pénétration de corps solides de dimensions supérieures à 1 mm. Protégé contre les gouttes d'eau.

Защищен от проникновения твердых частиц диаметром больше 1 мм. Защищен от просачивания.

IP44

Protetto contro la penetrazione di corpi solidi di dimensioni maggiori a 1 mm. Protetto contro gli spruzzi d'acqua.

Protected against entry of solid objects larger than 1 mm. Protected against water spray from.

Protección contra la penetración de cuerpos sólidos de dimensiones superiores a 1 mm. Protección contra las salpicaduras de agua.

Geschützt gegen das Eindringen von Festkörpern mit einer Größe über 1 mm. Geschützt gegen Wasserspritzer.

Protégé contre la pénétration de corps solides de dimensions supérieures à 1 mm. Protégé contre les éclaboussures.

Защищен от проникновения твердых частиц диаметром более 1 мм. Защищен от водяных брызг.

IP65

Totalmente protetto contro la polvere. Protetto contro i getti d'acqua.

Completely protected against dust. Protected against water jets.

Protección total contra el polvo. Protección contra los chorros de agua.

Vollständig gegen Staub geschützt. Geschützt gegen Wasserstrahl.

Totalelement protégé contre la poussière. Protégé contre les jets d'eau.

Полностью защищен от пыли. Защищен от водяных струй.

IP67

Totalmente protetto contro la polvere. Stagno all'immersione.

Completely protected against dust. Sealed against immersion up to 1 metre.

Protección total contra el polvo. Protección contra los efectos de la inmersión.

Vollständig gegen Staub geschützt. Dicht bei zeitweiligem Eintauchen.

Totalelement protégé contre la poussière. Étanche à l'immersion.

Полностью защищен от пыли. Водонепроницаем при погружении.

Specifiche locali bagno e docce
/ IP protection and class insulation for bathroom

Grado di protezione e classe di isolamento locali bagni e docce
Normativa CEI 64-8/7

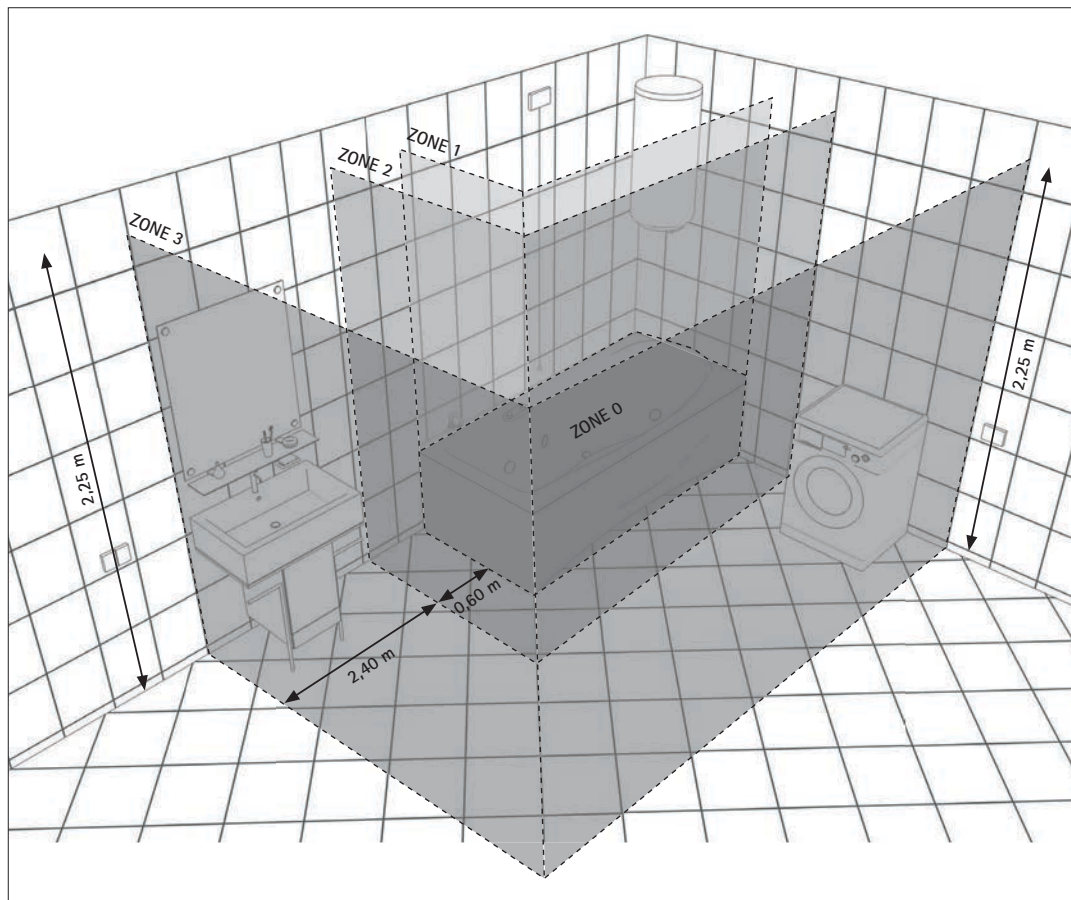

Zona 1

Grado di protezione IPX4
 (non inferiore a IPX5 nei bagni pubblici o di comunità quando è previsto l'uso di getti d'acqua per la pulizia).
 Classe di isolamento degli apparecchi illuminanti III.

Degree of protection IPX4 (not below IPX5 in public or community bathrooms when water jets are envisaged for cleaning).
 Lighting insulation class III.

Grado de protección IPX4 (no inferior a IPX5 en los baños públicos o de comunidad cuando está previsto el uso de chorros de agua para la limpieza).
 Clase de aislamiento de los aparatos iluminados III.

Schutzart IPX4
 (nicht unter IPX5 in öffentlichen Toiletten oder Gemeinschaftstoiletten, bei Reinigung mit Strahlwasser).
 Isolierklasse der Leuchten III.

Degré de protection IPX4
 (non inférieur à IPX5 dans les toilettes publiques ou communes lorsque l'utilisation de jets d'eau pour le nettoyage est prévue).
 Classe d'isolation des appareils d'éclairage III.

Степень защиты IPX4
 (не ниже IPX5 в общественных туалетах, если уборка предусматривает полив водой из шланга).
 Класс изоляции осветительных приборов III.

Zona 2

Grado di protezione IPX4
 (non inferiore a IPX5 nei bagni pubblici o di comunità quando è previsto l'uso di getti d'acqua per la pulizia).
 Classe di isolamento degli apparecchi illuminanti II, III e I purché protetto da interruttore differenziale da 30 mA.

Degree of protection IPX4
 (not below IPX5 in public or community bathrooms when water jets are envisaged for cleaning)
 Lighting insulation class II, III and I as long as protected by 30 mA residual current circuit breaker

Grado de protección IPX4
 (no inferior a IPX5 en los baños públicos o de comunidad cuando está previsto el uso de chorros de agua para la limpieza).
 Clase de aislamiento de los aparatos iluminados II, III y I siempre que esté protegido por un interruptor diferencial de 30mA.

Schutzart IPX4
 (nicht unter IPX5 in öffentlichen Toiletten oder Gemeinschaftstoiletten, bei Reinigung mit Strahlwasser).
 Isolierklasse der Leuchten II, III und I nur, wenn sie durch einen Differenzialschalter von 30mA geschützt sind.

Degré de protection IPX4
 (non inférieur à IPX5 dans les toilettes publiques ou communes lorsque l'utilisation de jets d'eau pour le nettoyage est prévue).
 Classe d'isolation des appareils d'éclairage II, III et I à condition qu'elle soit protégée par un interrupteur différentiel de 30 mA.

Степень защиты IPX4
 (не ниже IPX5 в общественных туалетах, если уборка предусматривает полив водой из шланга).
 Класс изоляции осветительных приборов II и III, даже I – если прибор защищен дифференцированным переключателем на 30 mA.

Zona 3

Grado di protezione IPX1
 (non inferiore a IPX5 nei bagni pubblici o di comunità quando è previsto l'uso di getti d'acqua per la pulizia).
 Classe di isolamento degli apparecchi illuminanti I, II, III.

Degree of protection IPX1
 (not below IPX5 in public or community bathrooms when water jets are envisaged for cleaning).
 Lighting insulation class I, II, III.

Grado de protección IPX1
 (no inferior a IPX5 en los baños públicos o de comunidad cuando está previsto el uso de chorros de agua para la limpieza).
 Clase de aislamiento de los aparatos de iluminación I, II, III.

Schutzart IPX1
 (nicht unter IPX5 in öffentlichen Toiletten oder Gemeinschaftstoiletten, bei Reinigung mit Strahlwasser).
 Isolierklasse der Leuchten I, II, III

Degré de protection IPX1
 (non inférieur à IPX5 dans les toilettes publiques ou communes lorsque l'utilisation de jets d'eau pour le nettoyage est prévue).
 Classe d'isolation des appareils d'éclairage I, II et III.

Степень защиты IPX1 (не ниже IPX5 в общественных туалетах, если уборка предусматривает полив водой из шланга).
 Класс изоляции осветительных приборов I, II и III.



CERTIFICATION PROJECT FORM

RECEIVED ON DATE _____

PROJECT
IDENTIFICATION
NUMBER

EXPIRING
DATE

(Area reserved to the
Company)

PROMOTER *		<input type="checkbox"/> DEALER	<input type="checkbox"/> AGENT	<input type="checkbox"/> _____
Fabbian Customer code <small>(if known)</small>		Company name		
Address				N°
Postal code	Town	Area code	State	
Telephone numb.	Fax numb.		E-mail	
Personal contact	Mobile		E-mail	

PROJECT REFERENCES WHERE FABBIAN PRODUCTS ARE SPECIFIED *				
Project ref.:				
Products specified				
(collections, fixture codes, quantities):				
Notes				
PROJECT CLIENT *	Company name			
	Address			
	Postal code	Town / State		N°
	Telephone numb.	Fax numb.		E-mail
	Personal contact	Mobile		E-mail
SPECIFIER *	Company name			
	Address			
	Postal code	Town / State		N°
	Telephone numb.	Fax numb.		E-mail
	Personal contact	Mobile		E-mail

CONTRACTOR (if known)	Company name			
	Address			
	Postal code	Town / State		N°
	Telephone numb.	Fax numb.		E-mail
	Personal contact	Mobile		E-mail
FINAL DESTINATION OF THE GOOD *	Company name			
	Address			
	Postal code	Town / State		N°
	Telephone numb.	Fax numb.		E-mail
	Personal contact	Mobile		E-mail

DOCUMENTATION PROVIDED *		
<input type="checkbox"/> Materials lists	<input type="checkbox"/> Tender articles and specifications	<input type="checkbox"/> _____

NOTES AND COMMENTS - dedicated attention is required if several Lighting Operators, Traders, Agents, or others persons or organizations are involved in the same project *		

Date	Stamp and sign	
------	----------------	--

* Data is required in marked fields

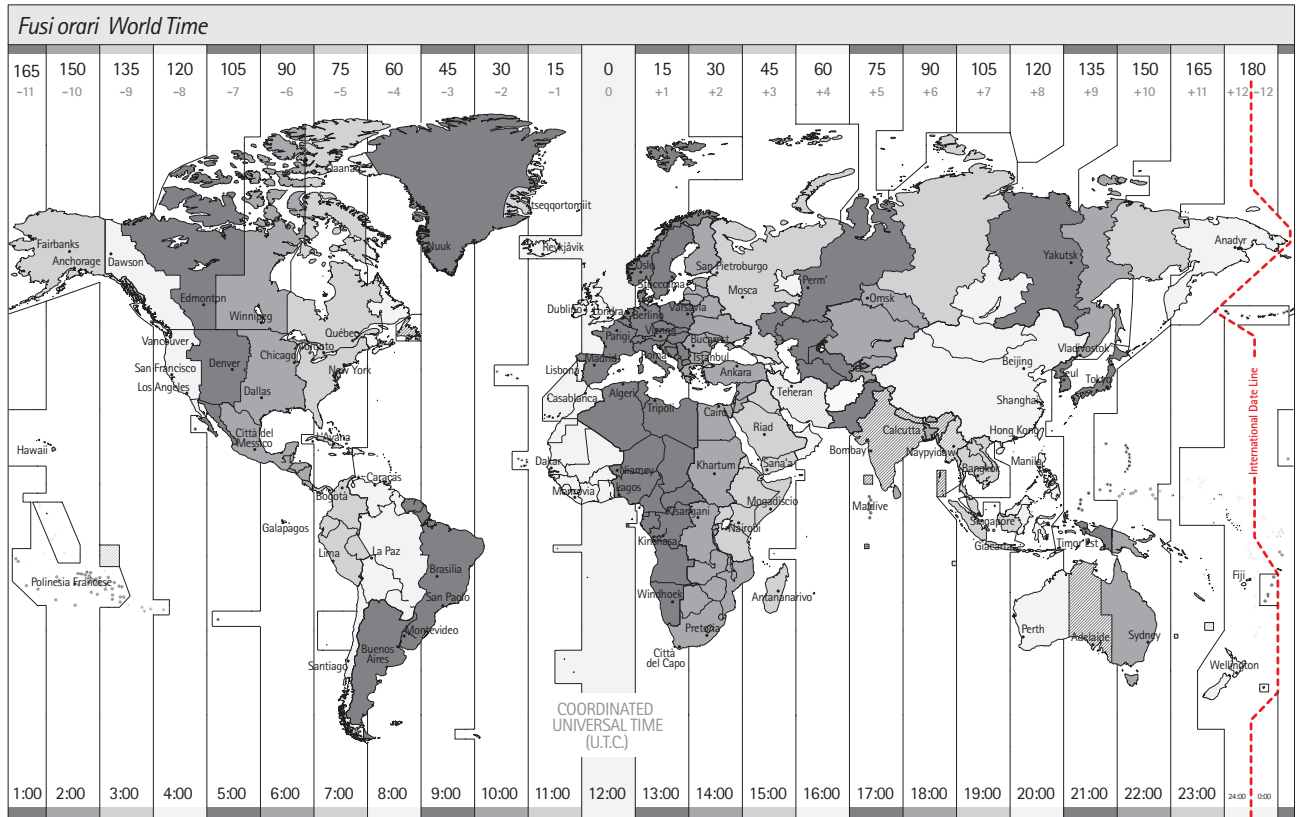

(local time)
ORARIO D'UFFICIO
 (da lunedì a venerdì)
OFFICE HOURS
 (from monday to friday)

8:00 - 17:00

Tel. +39.0423.4848
 Fax +39.0423.484395

SALES
 italia@fabbian.com
 export@fabbian.com
 info.btob@fabbian.com

NORTH AMERICA
 usa@fabbian.com
 canada@fabbian.com

HONG KONG
 asia@fabbian.com

GIORNI DI CHIUSURA AZIENDALE 2015
 / CLOSING DAYS 2015

01-06/01
 17/02 PM
 06/04
 25/04
 01/05
 01-02/06
 03-28/08
 08/12
 24-31/12

: Fabbian

E f.fabbian
ILLUMINAZIONE DAL 1961

ILLUMINAZIONE
DI INTERNI
df
STUDIO

Italy

Fabbian Illuminazione Spa
via Santa Brigida, 50
31020, Castelminio di Resana
Treviso
tel +39 0423 4848
fax +39 0423 484395
numero verde 800 800 444
www.fabbian.com

sales

italia@fabbian.com
export@fabbian.com

mkt & com

comunicazione@fabbian.com

Usa e Canada

Fabbian Usa Corp.
161 Dwight Pl.
Fairfield, NJ 07004, Usa
Ph. +1 973 882 3824
+1 973 882 3825
Fax +1 973 882 3826
+1.866 Fabbian
www.fabbian.us

sales

usa@fabbian.com
canada@fabbian.com

mkt & com

marketing.usa@fabbian.com

Asia

Fabbian Asia Ltd.
Suite 2306 Singaa Commercial Centre
144-151 Connaught Road West
Hong Kong
ph. +852 2915 8197
fax +852 2915 8192
www.fabbian.hk

sales

asia@fabbian.com