

...zhsllly  
...uinxxxz  
...maxnnchdur  
...planbfalcpX,nbfgi  
...ynbin,bigfenx  
...mommz)momg  
...ihnnxioh Ö  
...wepwr ikpkb-,  
...-LK JJJmjo  
...ihpwf vuhljb  
...fbpo,cv  
...npiu  
...? ip  
...f jhh  
...#

CARLESSO

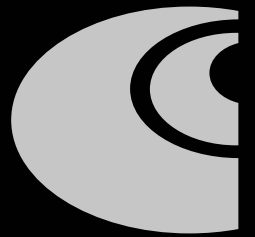

Nils

2 • 4



Tike

30 • 32



Scriptum

6



Odry

34 • 36 • 38



Lais

8 • 10



Audè

40 • 42 • 44



Gabri

12 • 14 • 16 • 18



Tam

46 • 48



Lobuan

20 • 22 • 24



Hoa

50 • 52



Pliet

26 • 28

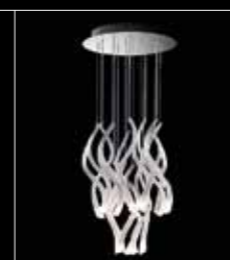

Mylea

54



CARLESSO 2010/2011

Lampada a sospensione in alluminio decorata esternamente in blu o grigio gofrato ed internamente in foglia argento o oro. Disponibile nelle dimensioni diametro 90 cm e 70 cm.

Pendant lamp in decorated aluminium with grey or blue embossed painting in the outside and gold or silver leaf hand decoration in the inside. Available in the 90 cm ( 35-7/8") or 70 cm (27-1/2") diameter size.

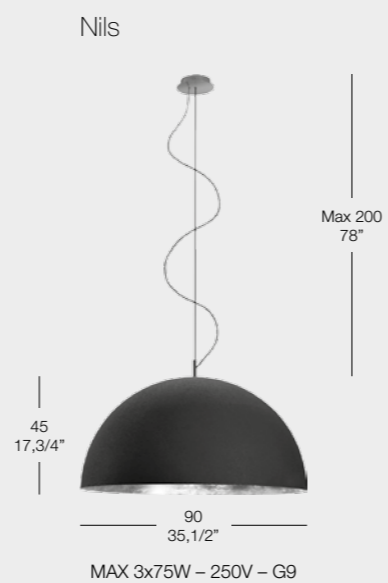

Nils

Vista dell'interno in foglia argento.

View of the silver leaf inside.

Nils



Lampada a parete con vetro temperato serigrafato. Sorgente luminosa fluorescente.

Wall sconce with a tempered and serigraphed glass. Fluorescent light source provided

# Scriptum

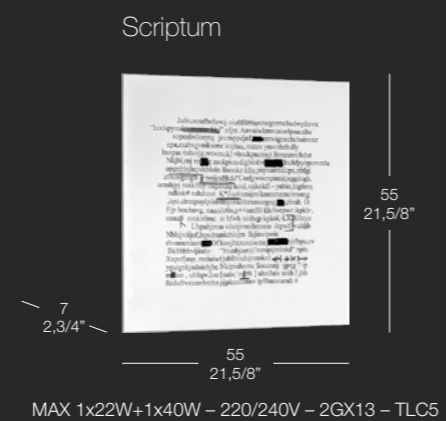
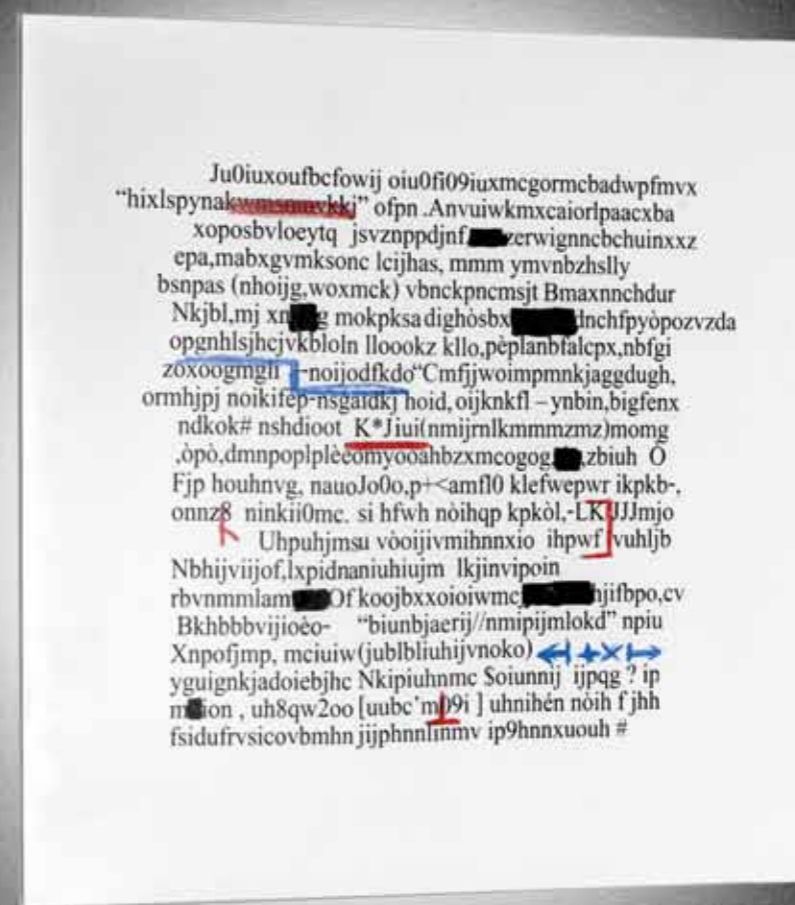

Lampada a sospensione decorata esternamente con colore verde iridescente ed internamente in foglia argento o oro. Disponibile nelle dimensioni diametro 90 cm e 70 cm.

Pendant lamp with a gloss iridescent green painting in the outside and gold or silver hand decorated leaf in the inside. Available in the 90 cm ( 35-7/8") or 70 cm (27-1/2") diameter size.

# Lais

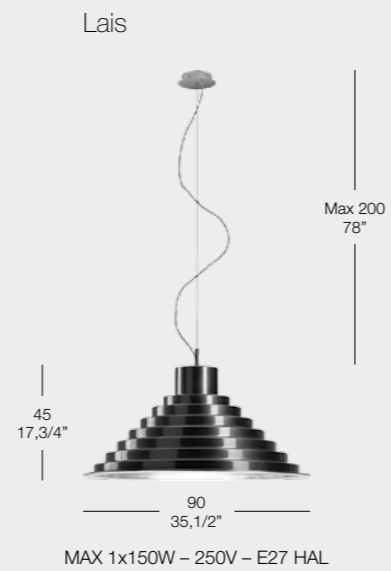

Dettaglio della verniciatura esterna  
iridescente.

View of the iridescent painting  
of the outside.

# Lais



Lampada a parete composta da due dischi in alluminio, con incisioni a taglio laser e decorata a foglia oro. Disponibile nelle varianti diametro 90 e 70 cm.

Wall sconce composed by two aluminium round plates with laser perforated patterns. Gold leaf hand decorated surfaces. Available in the 90 cm ( 35-7/8") or 70 cm (27-1/2") diameter size.

# Gabri

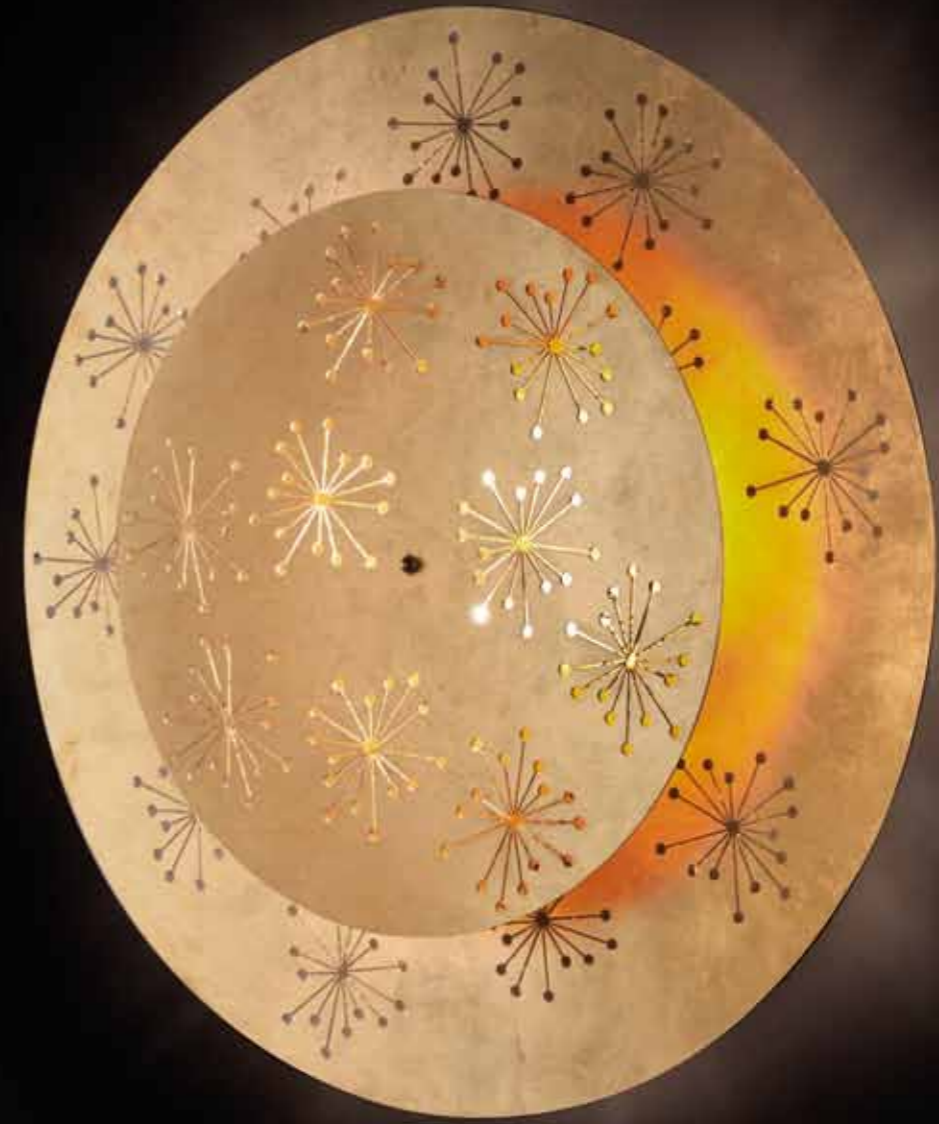

Gabri P gold

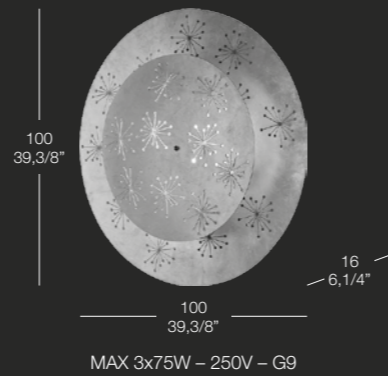



Lampada a plafone composta da due dischi in alluminio, con incisioni a taglio laser e decorata a foglia oro. Disponibile nelle varianti diametro 90 e 70 cm.

Ceiling sconce composed by two aluminium round plates with laser perforated patterns. Gold leaf hand decorated surfaces. Available in the 90 cm ( 35-7/8") or 70 cm (27-1/2") diameter size.



# Gabri

Gabri PL gold

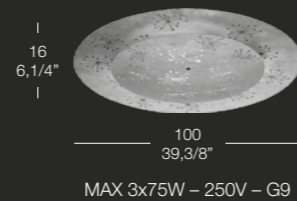

Lampada a parete composta da due dischi in alluminio, con incisioni a taglio laser. Decorata in bianco, nel disco maggiore, e foglia argento nel disco minore. Disponibile nelle varianti diametro 90 e 70 cm.

Wall sconce composed by two aluminium round plates with laser perforated patterns. Silver leaf hand decoration for the smaller disk and white painted finish for the biggest one. Available in the 90 cm ( 35-7/8") or 70 cm (27-1/2") diameter size.

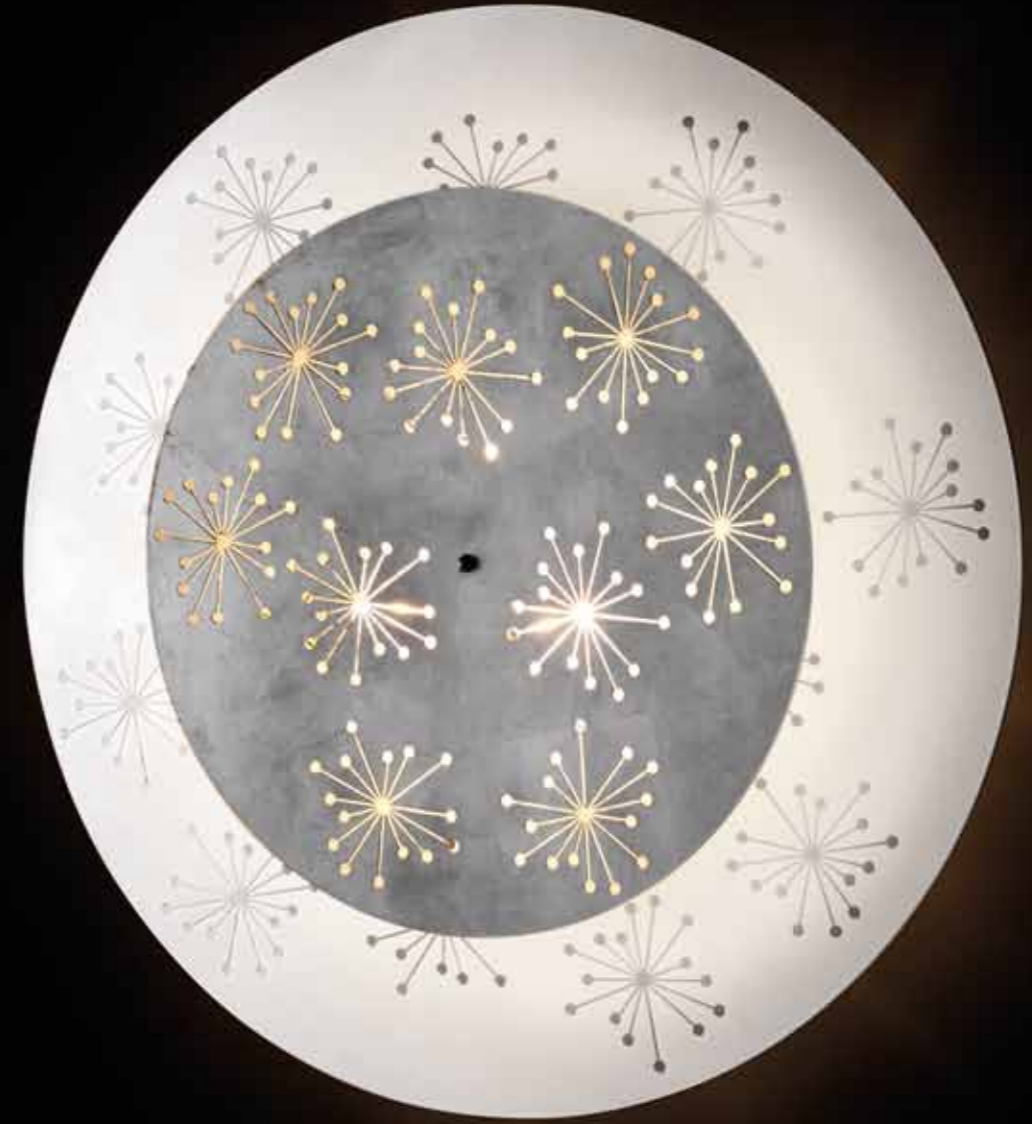

# Gabri

Gabri P silver

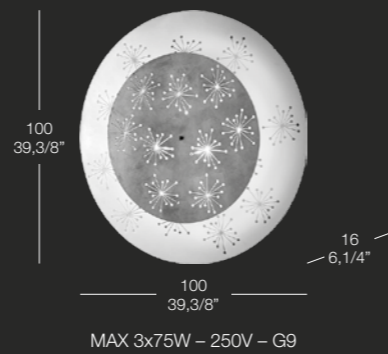

Lampada a plafone composta da due dischi in alluminio, con incisioni a taglio laser e decorata in bianco e foglia argento. Disponibile nelle varianti diametro 90 e 70 cm.

Ceiling sconce composed by two aluminium round plates with laser perforated patterns. Silver leaf hand decoration for the smaller disk and white painted finish for the biggest one. Available in the 90 cm ( 35-7/8") or 70 cm (27-1/2") diameter size.



# Gabri

Gabri PL silver

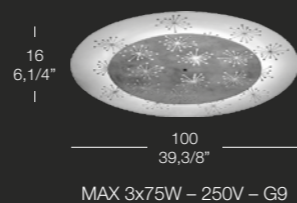

Lampadario con elementi decorativi e catene di perle in vetro soffiato color fume', particolari metallici in cromo. Disponibile nelle varianti 16+8, 12+6, 8+4, 10, 8, 6 luci. Paralumi in voile plissé di seta in tinta con bordo di decori Swarovski.

Grey smoked hand blown glass chandelier with decorative accents and pearl chains in the same hand blown glass colour. Available in several compositions as 16+8, 12+6, 8+4, 10, 8 or 6 light arms. Grey matched silk "Voile plissé" lampshades and decorated edge with Swarovski crystal elements.



# Lobuan

Lobuan S24

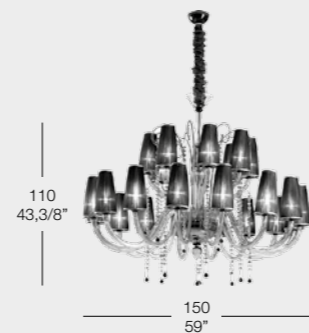

MAX 24x40W - 250V - E14

Lampadario con elementi decorativi e catene di perle in vetro soffiato color fume', particolari metallici in cromo. Disponibile nelle varianti 16+8, 12+6, 8+4, 10, 8, 6 luci. Paralumi in voile plissé di seta in tinta con bordo di decori Swarovski.

Grey smoked hand blown glass chandelier with decorative accents and pearl chains in the same hand blown glass colour. Available in several compositions as 16+8, 12+6, 8+4, 10, 8 or 6 light arms. Grey matched silk "Voile plissé" lampshades and decorated edge with Swarovski crystal elements.



Lobuan S8

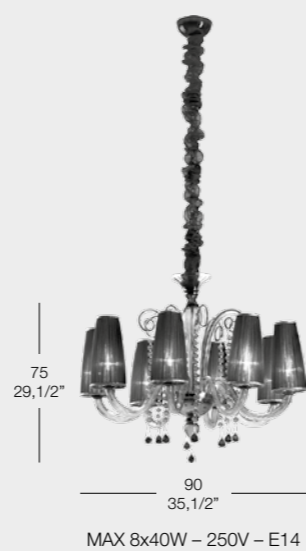

# Lobuan

Lampada a parete a 2 luci con elementi decorativi e catene di perle in vetro soffiato color fume', particolari metallici in cromo. Paralumi in voile plissé di seta in tinta con bordo di Swarovski.

Grey smoked hand blown glass wall sconce with 2 light arms. Decorative accents and pearl chains in the same hand blown glass colour. Grey matched silk "Voile plissé" lampshades and decorated edge with Swarovski crystal elements.



# Lobuan

Lobuan P

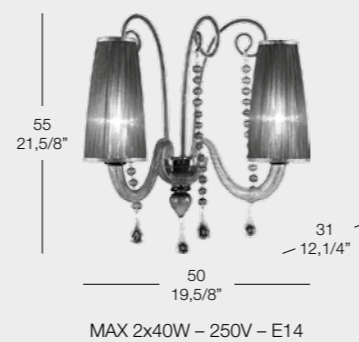

Composizione a sospensione nella versione rotonda con 18 diffusori ritorti in vetro soffiato su 2 livelli. Struttura a cassa verniciata in grigio alluminio e disco di copertura in acciaio lucido. Disponibile in altre varianti di diametro e forma, su progetto. Sorgenti luminose a basso voltaggio con trasformatore incluso.

Pendant chandelier in the round shaped version composed in two levels by 18 hand blown twisted glass diffusers. Metal structure in grey aluminium painted finish and polished steel cover plate also available in other customized size and form variations. Low voltage incandescent light source with transformer provided.



# Pliet

Pliet S18



Composizione a plafone nella versione rotonda con 18 diffusori ritorti in vetro soffiato su 2 livelli. Struttura in acciaio lucido disponibile in altre varianti di diametro e forma, su progetto. Sorgenti luminose a basso voltaggio con trasformatore incluso.

Ceiling sconce in the round shaped version composed in two levels by 18 hand blown twisted glass diffusers. Metal structure in grey aluminium painted finish and polished steel cover plate also available in other customized size and form variations. Low voltage incandescent light source with transformer provided.



# Pliet

Pliet PL

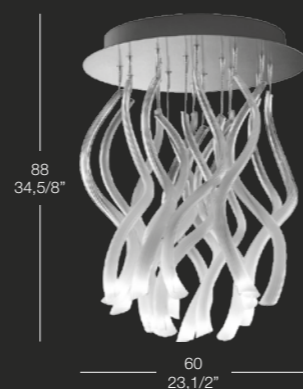

MAX 18x20W - 12V - GZ4



Composizione di lampade a sospensione  
in vetro borosilicato trasparente. Struttura in  
metallo cromato.

Pendant lamps composition with clear  
borosilicate blown glass. Metal structure with  
polished chrome finish.



Tike G

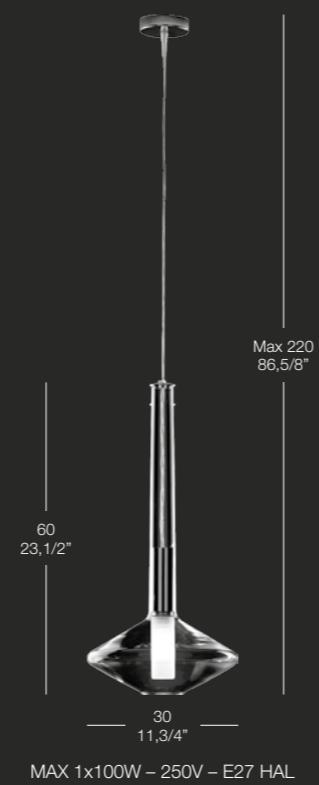

Tike

Lampada a sospensione in vetro borosilicato trasparente. Struttura in metallo cromato.

Pendant lamp with clear borosilicate blown glass. Metal structure with polished chrome finish.



# Tike

Lampadario in vetro soffiato bianco latte, disponibile nelle varianti a 10+5, 8+4, 10, 8 e 6 luci, particolari metallici in cromo, elementi decorativi e pendenti in vetro soffiato nero. Paralumi in seta bianca con decori neri.

White opaline hand blown glass chandelier available in the 10+5, 8+4, 10, 8 or 6 light arms. Chrome polished metal details and black hand blown glass pendant drops. White silk lamp shades with black decorated patterns.



# Odry

Odry S15

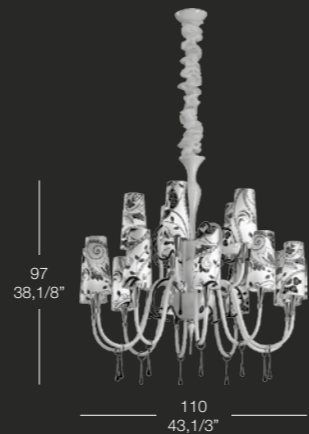

MAX 15x40W - 250V - E14



Lampadario in vetro soffiato bianco latte, disponibile nelle varianti a 10+5, 8+4, 10, 8 e 6 luci, particolari metallici in cromo, elementi decorativi e pendenti in vetro soffiato nero. Paralumi in seta bianca con decori neri.

White opaline hand blown glass chandelier available in the 10+5, 8+4, 10, 8 or 6 light arms. Chrome polished metal details and black hand blown glass pendant drops. White silk lamp shades with black decorated patterns.



Odry

Odry S8

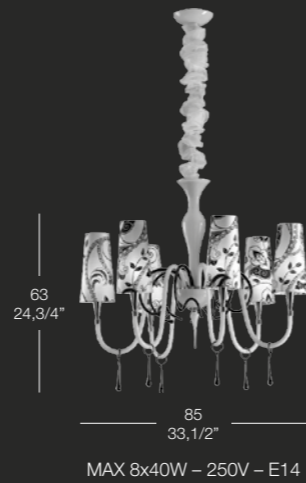

Lampada a parete in vetro soffiato bianco latte a 3 luci, particolari metallici in cromo, elementi decorativi e pendenti in vetro soffiato nero. Paralumi in seta bianca con decori neri.

Wall sconce in white opaline hand blown glass with 3 light arms. Chrome polished metal details and black hand blown glass pendant drops. White silk lampshades with black decorated patterns.



# Odry

Odry P

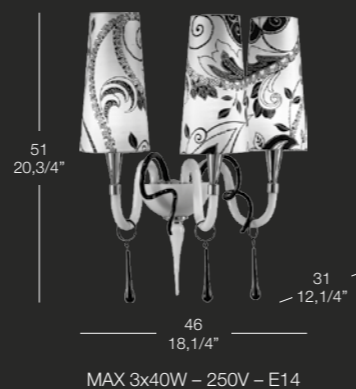

Lampadario in cristallo soffiato disponibile a 12, 10, 8 e 6 luci. Particolari metallici in cromo, elementi decorativi e pendenti diamantati in cristallo. Paralumi in seta bianca con decori tono su tono e piuma naturale o paralumi plissé in voile di seta bianca.

Hand blown glass chandelier in clear crystal available with 12, 10, 8 or 6 light arms. Chrome polished metal details and diamond shaped pendant drops. White silk lampshades with white decorated patterns and natural feathers. Also available with white silk "plissé" shades.



Audè S12

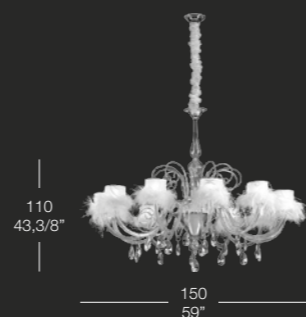

MAX 12x40W - 250V - E14

# Audè



Lampadario in cristallo soffiato disponibile a 12, 10, 8 e 6 luci. Particolari metallici in cromo, elementi decorativi e pendenti diamantati in cristallo. Paralumi in seta bianca con decori tono su tono e piuma naturale o paralumi plissé in voile di seta bianca.

Hand blown glass chandelier in clear crystal available with 12, 10, 8 or 6 light arms. Chrome polished metal details and diamond shaped pendant drops. White silk lampshades with white decorated patterns and natural feathers. Also available with white silk "plissé" shades.



Audè S8

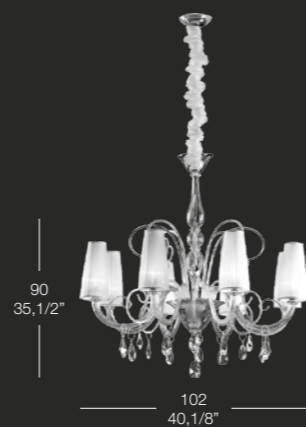

MAX 8x40W - 250V - E14

# Audè



Lampada a parete in cristallo soffiato a 2 luci, particolari metallici in cromo, elementi decorativi e pendenti diamantati in cristallo. Paralumi in seta bianca con decori tono su tono e piuma naturale o paralumi plissé in voile di seta bianca.

Wall sconce in clear crystal hand blown glass with 2 light arms. Chrome polished metal details and diamond shaped pendant drops. White silk lampshades with white decorated patterns and natural feathers. Also available with white silk "plissé" shades.



Audè P

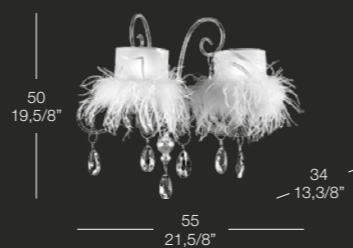

MAX 2x40W - 250V - E14

# Audè



Lampada da tavolo in maiolica decorata a mano in nero lucido. Paralume in seta a righe con fondo nero.

Gloss black hand decorated "majolica" table lamp. Striped silk lampshade on a black background.



Tam black



# Tam



Lampada da tavolo in maiolica decorata a mano in bianco lucido. Paralume in seta a righe con fondo bianco.

Gloss white hand decorated "majolica" table lamp. Striped silk lampshade on a white background.

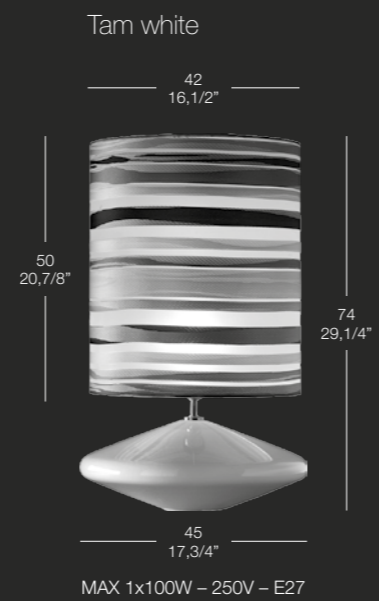

# Tam



Lampada da terra in maiolica lavorata e decorata a mano in azzurro polvere. Paralume in seta blu con decori tono su tono.

Light blue hand crafted and decorated "majolica" floor lamp. Blue silk lampshade with blue optical patterns matched with the colour base.



Hoa



Lampada da tavolo in maiolica lavorata e decorata a mano in azzurro polvere. Paralume in seta blu con decori tono su tono.

Light blue hand crafted and decorated "majolica" table lamp. Blue silk lampshade with blue optical patterns matched with the colour base.

# Hoa



Lampada da tavolo in maiolica decorata a mano in foglia oro. Paralume fondo amaranto con decori oro.

Hand crafted "majolica" table lamp with hand decorated gold leaf. Lampshade with an orange background and gold patterns.



Mylea



I prodotti contenuti in questo catalogo sono marchiati CE in conformità alle Direttive Comunitarie di Bassa Tensione, a garanzia della sicurezza del consumatore per gli usi previsti.

Ci riserviamo il diritto di apportare modifiche ai nostri prodotti, in qualunque momento e senza darne pubblico preavviso.

All the products included in this catalogue are CE marked according to the European Community Regulations for low tension as guarantee for the customer safety and for the regular use.

We reserve the right to make modifications to our products at any time and without giving previous notice.

...p-nsgaidkj hoio  
K\*Jiui(nm  
nauoJo0o,p+<am  
si hfwh nòihqp  
vòoijivmihnn  
lkjinvip  
\$oiunnij  
uhnihén no  
ip9hnnxuou